

Final Report

**FEHMARNBELT FIXED LINK
BIRD SERVICES (FEBI)**

Bird Investigations in Fehmarnbelt - Baseline

Bird Migration

E3TR0011 Volume III

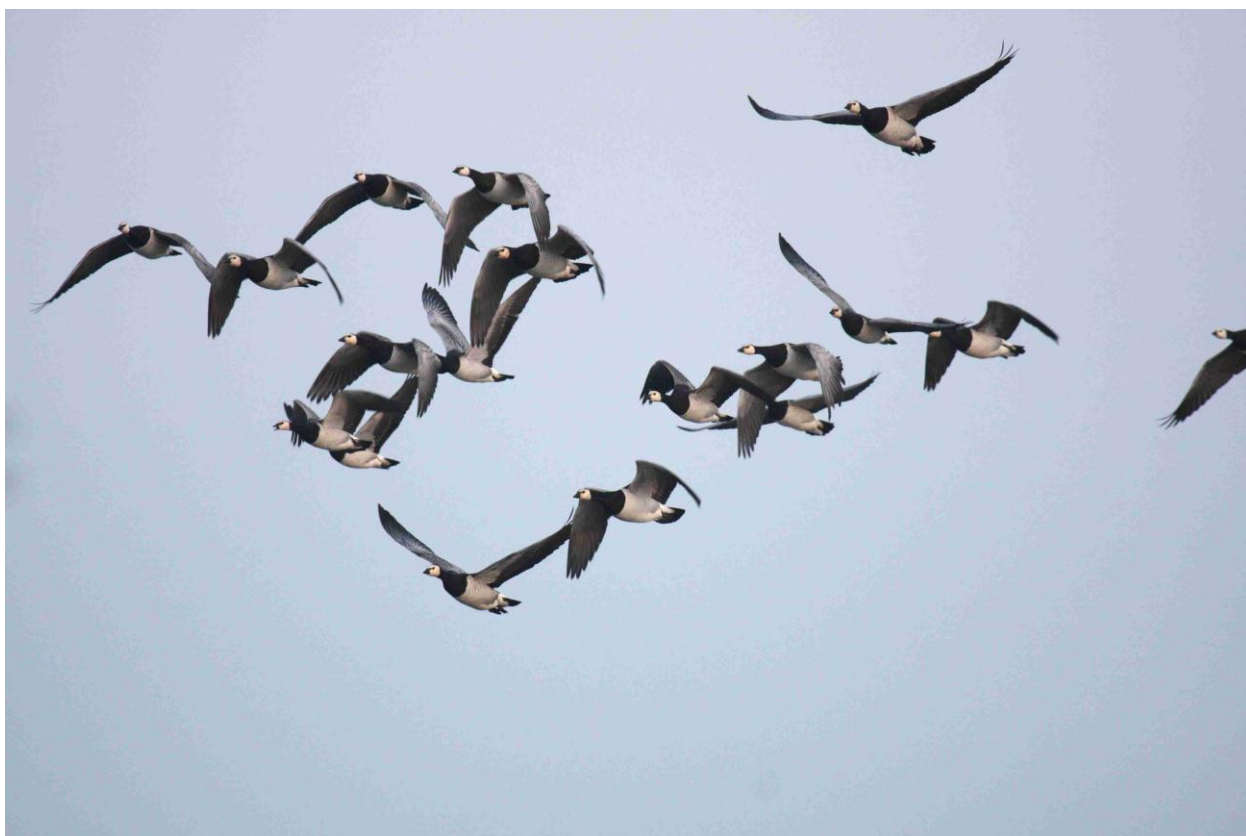

Prepared for: Femern A/S
By: DHI / BioConsult SH Consortium
in association with University of Copenhagen and BIOLA

Responsible editor:

FEBI consortium / co DHI
Agern Allé 5
DK-2970 Hørsholm
Denmark

FEBI Project Director: Anders Malmgren Hansen, DHI
www.dhigroup.com

Please cite as:

FEBI (2013) Fehmarnbelt Fixed Link EIA.
Bird Investigations in Fehmarnbelt – Baseline.
Volume III. Bird Migration.
Report No. E3TR0011

Report: 333 pages

Appendices (ISBN 978-87-92416-86-5)

May 2013

ISBN 978-87-92416-52-0

Maps:

Unless otherwise stated:

DDO Orthofoto: DDO®, copyright COWI

Geodatastyrelsen (formerly Kort- og Matrikelstyrelsen), Kort10 and 25 Matrikelkort

GEUS (De Nationale Geologiske Undersøgelser for Danmark og Grønland)

HELCOM (Helsinki Commission – Baltic Marine Environment Protection Commission)

Landesamt für Vermessung und Geoinformation Schleswig-Holstein (formerly

Landesvermessungsamt Schleswig-Holstein) GeoBasis-DE/LVermGeo SH

Photos:

Thomas W. Johansen (Cover page, p 52-53), Jan Blew (p 51, 54), Felix Liechti (p 61),
Stefan Wolff (p 56, 62)

© Femern A/S 2013

All rights reserved.

The sole responsibility of this publication lies with the author. The European Union is not responsible for any use that may be made of the information contained therein.



FEHMARNBELT BIRDS

CONTENTS

1	SYNTHESIS - MIGRATION STRATEGIES AND SPECIES ACCOUNTS	1
1.1	Introduction	1
1.2	Waterbirds preferentially migrating over the water (type 1 species)	2
1.2.1	Seaducks	3
1.2.2	Divers, grebes, mergansers and auks	13
1.2.3	Terns	18
1.2.4	Summary	18
1.3	Waterbirds less dependent to migrate over water (type 2 species)	19
1.3.1	Swans, dabbling and diving ducks	19
1.3.2	Geese	22
1.3.3	Waders	24
1.3.4	Gulls	26
1.3.5	Summary	28
1.4	Landbirds migrating during daytime (type 3 species)	28
1.4.1	Birds of prey	30
1.4.2	Common Crane	37
1.4.3	Pigeons	37
1.4.4	Passerines – daytime migrants	38
1.4.5	Summary	43
1.5	Landbirds migrating over a broad-front during night-time (type 4 species)	43
1.5.1	Passerines – night-time migrants	44
1.5.2	Summary	46
2	INTRODUCTION	47
3	METHODS	49
3.1	Study site descriptions	51
3.1.1	Puttgarden (Fehmarn, Germany)	51
3.1.2	Westermarkelsdorf (Fehmarn, Germany)	51
3.1.3	Rødbyhavn (Lolland, Denmark)	52
3.1.4	Fehmarnbelt Offshore	54
3.1.5	Hyllekrog offshore station	55
3.2	Observation Methods	55
3.2.1	Visual observations	55
3.2.2	Night acoustics	56
3.2.3	Morning census	57
3.2.4	Surveillance radar	58
3.2.5	Swiss tracking and pencil beam radar - ‘Superfledermaus’	59
3.2.6	Weather data	61
3.3	Databases	62
3.4	Data analyses	62
3.4.1	Surveillance radars – screenshot analyses	62
3.4.2	Horizontal surveillance radar – spatial analyses of intensities and flight directions	64
3.4.3	Real-time tracking using horizontal surveillance radar	72
3.4.4	Swiss tracking and pencil beam radar – ‘Superfledermaus’	73
3.4.5	Bird migration behaviour and wind	75
3.4.6	Bird migration intensity and weather	76
3.5	Observation effort and radar coverage	79
3.6	Assessment of methods and coverage	81
4	RESULTS	84

FEHMARNBELT BIRDS

4.1	Species composition and absolute numbers	84
4.1.1	Puttgarden onshore station	85
4.1.2	Rødbyhavn onshore station.....	88
4.1.3	Fehmarnbelt - offshore station	91
4.1.4	Hyllekrog - offshore station.....	93
4.1.5	Discussion of species composition / occurrence at different stations	94
4.1.6	Comparison of own results with other migration observation stations.....	97
4.2	Migration intensities and phenologies	101
4.2.1	Migration intensities as registered by visual and acoustic observations	103
4.2.2	Migration phenologies as registered by vertical surveillance radar and pencil beam radar	117
4.2.3	Summary and assessment of migration intensities in the Fehmarnbelt region	124
4.3	Flight directions and flight paths.....	126
4.3.1	Flight directions and flight paths as registered by visual observations	127
4.3.2	Flight directions - Horizontal surveillance radar real-time tracking	140
4.3.3	Flight directions and flight paths - horizontal surveillance radar screenshot data.	154
4.3.4	Summary	172
4.4	Flight altitudes	174
4.4.1	Flight altitude as registered by visual observations	174
4.4.2	Flight altitude as registered by vertical surveillance radar and fixed pencil beam radar	187
4.5	Three-dimensional flight paths as registered by the tracking radar.....	204
4.5.1	Rødbyhavn, Lolland 2009	204
4.5.2	Puttgarden, Fehmarn 2010	209
4.6	Arrival at and departures from the coasts – analysis of bird behaviour and strategies	211
4.6.1	Identified tracks at daytime 2009	212
4.6.2	Unidentified tracks – night-time 2009 and 2010	230
5	BIRD MIGRATION AND WEATHER	243
5.1	Bird migration behaviour and wind – visual observations	243
5.1.1	Introduction.....	243
5.1.2	Migration intensity and directions in dependence of wind.....	244
5.1.3	Distance to the coast in dependence of wind.....	250
5.2	Bird migration and weather parameters - night-time acoustic observations.....	251
5.2.1	Barnacle Goose	252
5.2.2	Wigeon.....	253
5.2.3	Eurasian Curlew	255
5.2.4	Skylark	257
5.2.5	Tree Pipit.....	259
5.2.6	Robin	262
5.2.7	Blackbird	265
5.2.8	Song Thrush	267
5.2.9	Summary	270
5.3	Bird migration intensity and weather: modelling for selected species	271
5.3.1	Common Eider	272
5.3.2	Barnacle Goose	284
5.3.3	Common Buzzard	294
5.3.4	Honey Buzzard.....	305
5.3.5	Tree Pipit.....	314
5.3.6	Greenfinch.....	321
5.3.7	Discussion and conclusions	321
5.4	Summary	323
6	REFERENCES	324

FEHMARNBELT BIRDS

Lists of figures and tables are included as the final pages

Note to the reader:

In this report the time for start of construction is artificially set to 1 October 2014 for the tunnel and 1 January 2015 for the bridge alternative. In the Danish EIA (VVM) and the German EIA (UVS/LBP) absolute year references are not used. Instead the time references are relative to start of construction works. In the VVM the same time reference is used for tunnel and bridge, i.e. year 0 corresponds to 2014/start of tunnel construction; year 1 corresponds to 2015/start of bridge construction etc. In the UVS/LBP individual time references are used for tunnel and bridge, i.e. for tunnel construction year 1 is equivalent to 2014 (construction starts 1 October in year 1) and for bridge construction year 1 is equivalent to 2015 (construction starts 1st January).

1 SYNTHESIS - MIGRATION STRATEGIES AND SPECIES ACCOUNTS

1.1 Introduction

At the region of the Fehmarnbelt long-distance migration of land- and waterbirds occurs and short-distance movements of waterbirds take place. The long-distance migrations are undertaken by large populations of seaducks, arctic geese, passerines, pigeons and birds of prey. Short-distance movements are conducted by staging, moulting, wintering or resident waterbirds moving back and forth between areas.

Migration is a sensitive period in the annual life-cycle of birds and each species has evolved a specific migration strategy with respect to seasonal and diurnal timing, flight height, choice of stop-over sites, response to weather conditions and other features (for overview see Alerstam 1990, Berthold 2001, Newton 2008). During the baseline study, data of 230 bird species migrating through Fehmarnbelt have been collected and additional data have been screened for species which could not be detected with available methods but are assumed to migrate through the area. It is not possible to describe each species in detail in this report, but it is the scope to describe general aspects of different migration strategies and species groups, highlight important features and go into specific details only for particular important species.

An overview of bird migration at the Fehmarn link – also with a view on potential impacts – is best described by separating different bird species groups according to their migration behaviour. In the following section, the four main types of migration behaviour of the associated species groups are identified and will be further addressed:

1. Waterbirds preferentially migrating over water (type 1 species)
2. Waterbird species less dependent to migrate over water (type 2 species)
3. Landbirds migrating during daytime (type 3 species)
4. Landbirds migrating broad-front during night-time (type 4 species)

A finer resolution of these groups is possible by looking for example at migration distances (short-, medium- and long-distance migrants), species-specific timing of migration and weather dependencies. However, in the following mainly these four types will be further described, and relevant issues for each of these species types will be laid out and assessed with regard to the function and importance of the Fehmarnbelt during their migration.

To cover these different migration types, the baseline investigations were based on visual and radar observations (horizontal and vertical surveillance radar, fixed pencil beam, tracking radar ("Superfledermaus")) as well as acoustic surveys in the Fehmarnbelt region. Investigations were carried out at two land locations on the coast (Lolland and Fehmarn) and from a ship anchored in the middle of Fehmarnbelt. The investigations were mainly performed during the migratory months, but also during the moulting period. Thus, results exist from February to November in 2009 and 2010, in accordance with the requirements specified in

FEHMARNBELT BIRDS

the scoping of the environmental investigations programme for the fixed link across Fehmarnbelt (Femern A/S and LBV 2010).

1.2 **Waterbirds preferentially migrating over the water (type 1 species)**

Many species of waterbirds prefer migrating over water for reasons of safety or e.g. foraging behaviour as they have the ability to interrupt their migratory flights at any time in response to adverse weather or other stimuli. Typical representatives for this migration strategy in the Fehmarnbelt are seaduck species (Common Eider – *Somateria mollissima*, Common Scoter – *Melanitta nigra*, Long-tailed Duck – *Clangula hyemalis*), the *Gavia* divers, the grebes, the mergansers, the auks and terns. *Gavia* divers, Common Eider and auks have in common to be heavy species with high wingloads (Lovvorn and Jones 1994, Dierschke 2001, Videler 2005, Pelletier et al., 2008) and imperfect flight abilities and will migrate over sea, as there they feel safe. Other species like terns combine foraging and migration which would not be possible on land. The behaviour to migrate over sea is mainly described for diurnal migration and low flight altitudes (Dierschke 2002, Dierschke and Daniels 2003). However, some of these species are known to migrate at night as well (Alerstam et al., 1974, Nehls and Zöllick 1990, Leopold et al., 1995, Kaiser et al., 2005) and it is not fully clear to what extent this migration pattern applies to nocturnal migration. For example, from the baseline investigations in Fehmarnbelt it appeared that Common Scoters almost exclusively fly over water during the day, whereas their calls were frequently recorded over land at night.

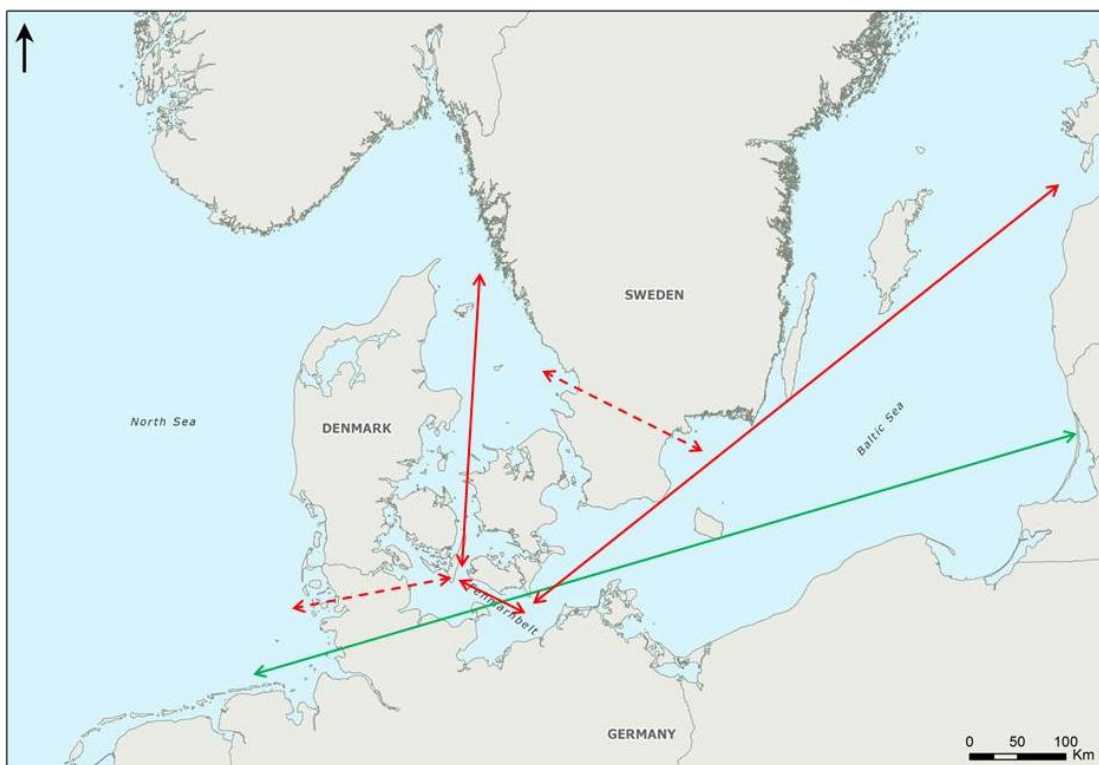

Figure 1.1 Schematic migration routes of waterbirds across the Fehmarnbelt Region. Red solid lines: waterbird species preferring to fly over water; dashed red lines: waterbirds preferring to fly over water, but crossing land in order to avoid large detours; green solid line: geese, ducks, waders with less pronounced preferences to fly over water.

FEHMARNBELT BIRDS

Main migration routes of waterbirds preferentially migrating over water are shown as red solid lines in Figure 1.1. These are migration routes to and from breeding places around the Baltic Sea and wintering and resting places in the Baltic Sea and North Sea, of which most, but not all, lead through the Fehmarnbelt (see chapter 5.3.1). These migration routes will almost not change in dependence of weather conditions. Dashed red lines represent migration routes of some of those species crossing over land most likely to avoid large detours.

1.2.1 **Seaducks**

Seaducks are the most common group of species preferentially migrating over water and represented in both years nearly the same fraction of all visually counted birds (34 % in 2009, 32 % in 2010) and between 1.1 % (2009) and 4.3 % (2010) of all acoustic registrations during night-time. Compared to data from Falsterbo (chapter 4.1.6), the total number of migrating seaducks in the Fehmarnbelt area was more than three-times higher e.g. during autumn 2009 (267.000 migrating seaducks at Fehmarn compared to 79.500 at Falsterbo), suggesting that most of the birds from the Baltic Sea fly through the Fehmarnbelt.

Among the seaducks, the Common Eider was the most abundant species constituting one-third of all visually counted birds in both baseline years (29.5 % in 2009, 27.6 % in 2010) (that is some 87 % of the seaducks in both years). Common Scoter was the second most common species with a fraction of around 4 % of all visually counted birds (4.16 % in 2009, 3.94 % in 2010). Other seaduck species were only counted in low numbers. 2,370 Long-tailed Ducks have been counted in total, constituting a very small fraction of the biogeographic population of 4.6 million birds mainly wintering in the Baltic Sea. Besides, 398 Velvet Scoters (*Melanitta fusca*) and 444 Goldeneye (*Bucephala clangula*) were registered. Altogether, these three species only contributed 0.17 % (2009) and 0.21 % (2010) of all sightings.

High migration intensities of these species were observed during spring at the Lolland coast with mainly coast-parallel migration directions towards SE and lower intensities at the Fehmarn coast and offshore in the Fehmarnbelt with a higher variation in flight directions. Flying altitudes were mainly below 100 m. During autumn, migration intensities at both coasts were medium to high, but higher at the Fehmarn coast, and again low in central Fehmarnbelt. Main migration directions were coast-parallel NW. Main flight altitudes were also below 100 m in autumn (see chapters 0, 4.3.1 and 4.4.1).

The baseline observations showed a preference during daytime for near-coast migration. The leading line effect of the coasts is assumed with birds during spring "hitting" the Lolland coast and following it and birds during autumn "hitting" the Fehmarn coast and following it, concluded from the seasonally different migration intensities recorded at the different field stations (chapters 4.1 and 0). Despite the leading line effect the recorded migration intensities decreased in proximity to the coastline (< 800 m distance). The baseline observations and analysis indicated an influence of weather and wind conditions. E.g. the highest migration intensities were observed during tailwind situations and good visibility (chapter 5.3.1).

FEHMARNBELT BIRDS

Due to their high numbers and proportions of recordings, Common Eider and Common Scoter are treated further.

Common Eider

The biogeographic population of Common Eider is estimated at 760,000 individuals in 2000, having declined from some 1.2 million in 1991. Concurrent declines from 800,000 to 370,000 have occurred in Danish waters (Desholm et al., 2002, Wetlands International 2006, Mendel et al., 2008).

Phenology and intensity

Common Eider exhibits a characteristic phenology (see Figures in Appendix A.2.7). The timing of spring migration depends on winter strength and temperatures, with most birds migrating through Fehmarnbelt February/March ending early April with some birds still in mid-April e.g. at Rødbyhavn. In 2009, when migration was at it highest from March 21 to March 31 at Rødbyhavn four peaks close to and above 2,000 individuals/hour (ind./h) were observed. In 2010 four peaks close to and above 2,000 ind./h were observed between March 27 and April 7. At Puttgarden, spring migration intensities of some 500 ind./h were observed during both years. Offshore in the Fehmarnbelt less than 10,000 individuals were counted during the spring seasons each year, with migration intensities generally below 200 ind./h.

During the summer moult migration phenology did not show a clear pattern. During both baseline years short peaks occurred during June (2009: June 23-25, 2010: June 22-24). In 2009, migration intensities around 100 ind./h were recorded from July 29 to August 6. In July/August 2010 no clear migration peak occurred. Both at Rødbyhavn and offshore in the Fehmarnbelt migration intensities were generally low between June and August.

During autumn, migration was scattered until late September and afterwards with regular migration intensities above 500 ind./h at Puttgarden. At Puttgarden, the migration intensity during autumn 2010 was obviously higher than during autumn 2009 with three peaks around and above 2,000 ind./h by September 28-30. Both at Rødbyhavn and offshore Fehmarnbelt considerably lower autumn intensities were recorded. At the Hyllekrog offshore station two peaks of 475 ind./h and 650 ind./h were registered on October 5/6, 2009.

Results of modelling of Common Eider migration reveals that wind direction is an important trigger in regulating migration both during spring and autumn. In autumn the decrease of air temperature also plays a role for migration intensity (chapter 5.3.1).

Flight directions

Flight directions of Common Eider at both onshore stations were clearly coast-parallel during 2009 and 2010 (Figure 1.2, Figure 1.3). At Rødbyhavn in spring flight directions were strictly SE, while at Puttgarden both NW(-W) and SE(-E) directions occurred.

FEHMARNBELT BIRDS

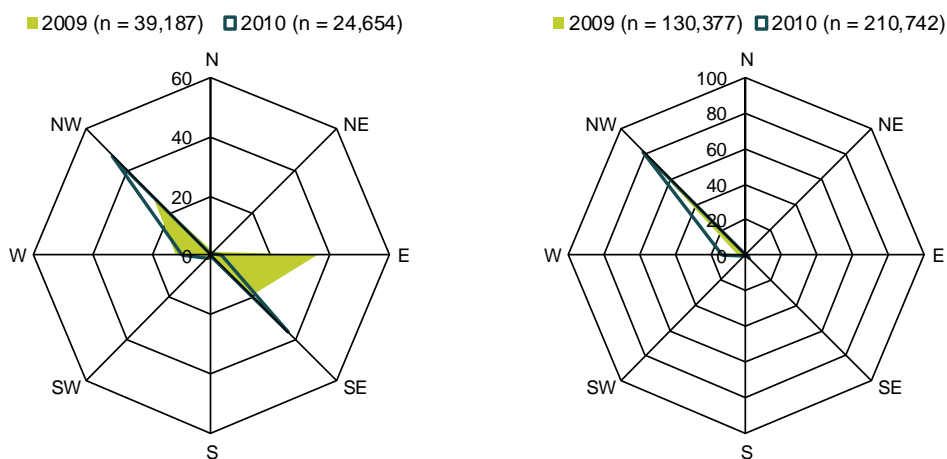

Figure 1.2 Daytime visual observations at Puttgarden onshore station: flight directions of Common Eider in spring (left) and autumn (right); results given in %.

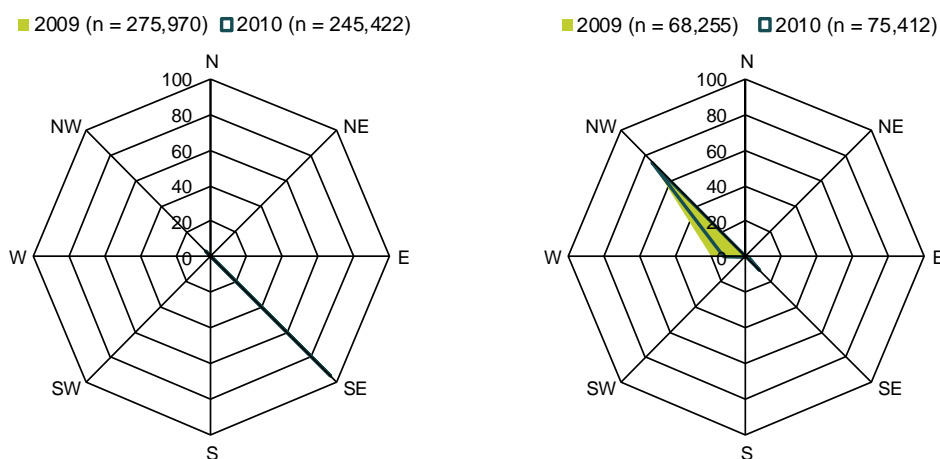

Figure 1.3 Daytime visual observations at Rødbyhavn onshore station: flight directions of Common Eider in spring (left) and autumn (right); results given in %.

Short-distance movements may have added to long-distance migration movements at Puttgarden, whereas at Rødbyhavn long-distance migration clearly dominated. These results were substantiated by real-time tracking by the horizontal radar (chapter 4.3.2, Figure 4.31). In addition the results coincide with the observations at Rødbyhavn by the tracking radar ('Superfledermaus') during spring 2009 (mean flight direction 125° [n=406 tracks] Appendix B.1). At the Fehmarnbelt offshore station flight patterns differed from those registered from the land stations. Here, easterly (NE, E, SE) directions were most common and additionally in 2009 some birds flew in NW-W directions.

During autumn nearly all birds flew NW-W at all stations (Figure 1.2, Figure 1.3 and chapter 4.3.1). At the Fehmarnbelt offshore station about 60 % of the Common Eider flew in NW direction and 40 % flew in W direction during 2009. In 2010 the preferred flight directions were westwards.

Flight altitudes

Visual observations showed that the vast majority of Common Eiders flew below 30 m (Figure 1.4). Only at the Rødbyhavn location some 15 % of the Common Eiders were registered flying in the altitude band 30-100 m during the spring seasons in 2009 and 2010. The 'Superfledermaus' recorded a mean altitude for Common Eiders of 24 m during spring 2009 (n=406 tracks) (see Appendix B.1). The vertical surveillance radar did not provide species-specific results.



Figure 1.4 Daytime visual observations at Puttgarden onshore station (top) and Rødbyhavn onshore station (bottom): flight altitudes of Common Eider in spring (left) and autumn (right) 2009 and 2010.

Common Scoter

The European population of Common Scoter, one of most numerous seaduck species in the Western Palaearctic, is estimated at 1.6 million individuals and stable, based on an estimate from 1993 (Pihl and Laursen 1996). Common Scoters near the coasts of the North and Baltic Sea and the Atlantic down to Morocco and returns for breeding to the lakes and rivers of the north European boreal forests. Recently, large numbers of Common Scoters have been counted in the Kattegat (Petersen 2006) and the North Sea (Petersen and Fox 2007) confirming or eventually raising the estimated population.

However, Common Scoter is a species, for which firstly some parts of its migration are not yet fully described, and secondly evidence exists, that it may perceive structures like bridges as strong barriers in their migratory paths having the potential to interrupt traditional migration routes (Hicklin and Bunker-Popma 2001, Bunker-Popma 2006, MacKinnon and Kennedy 2006).

Consequently, the subchapter on Common Scoter is somewhat more comprehensive than for the other species and species groups.

FEHMARNBELT BIRDS

Common Scoters have three periods of migratory activity – spring migration from the wintering grounds to the breeding areas, late summer moult migration of individuals which are not breeding or finished breeding season earlier, and autumn migration. During spring birds pass the southwest Baltic in late March – early April, stay in the Baltic Sea for some weeks and reach the Gulf of Finland by mid-May (Busche et al., 1993). Satellite telemetry during the baseline studies showed that migration in the Baltic Sea region consisted of a number of flights covering varying distances between stop-over sites, where each staging had a duration of several days. During moult, Common Scoters aggregate in the North Sea at the western coast of Jutland peninsular as well as in the south-easterly North Sea west of the German coast (Salomonsen 1968, Laursen et al., 1997, Mendel et al., 2008).

The daytime migration occurs at low altitudes over the water (Nehls & Zöllick 1990, Fox et al., 2003, Petersen and Fox, 2007). Overland day time migration is also reported, but it happens very seldom, often in the evening and at high altitudes, up to 4,000 m (see review in Busche et al., 1993). Radar studies in Finland show that a large proportion of Common Scoters migrate overland at night (Bergman 1974). There is a low number of observations in the western Baltic showing that Common Scoters migrate at night, but systematic studies of this phenomenon elsewhere have only provided very few results (Tulp et al., 1999, Dirksen et al., 2004). During spring Common Scoters cross the Jutland peninsular between North Sea and Baltic Sea at night (Busche et al., 1993).

However, the breeding areas of these birds occur deep inside of the continent, and obviously the individual birds get to these breeding places by flying over land. The relative importance of diurnal and nocturnal phases of migration of Common Scoters at different parts of migratory route remains unclear.

Phenology and intensity

Common Scoter phenology differs from Common Eider. They migrate earlier in spring than Common Eider with peak intensities already at the end of February until mid-March. In spring, the phenology pattern baseline observations were comparable between stations. However, more Common Scoters were observed in 2010 compared to 2009. In 2009 intensities above 100 ind./h were only observed during four days at Puttgarden alone, whereas in 2010 intensities above 100 ind./h were observed for two days at Puttgarden, for four days at Rødbyhavn and for three days in the offshore Fehmarnbelt.

Moult migration occurred in intensities > 250 ind./h at Puttgarden both on July 29 and August 4/5 in 2009 and August 10 in 2010. At Rødbyhavn only one small peak (> 100 ind./h) occurred in 2009 (July 27) and another in 2010 (August 10). Offshore in the Fehmarnbelt only one distinct peak occurred with 394 ind./h on August 1, 2009.

Autumn migration was scattered with no obvious pattern. It occurred mainly at Puttgarden from August to mid-November, and in 2009 with lower intensities offshore in Fehmarnbelt until late September. At Rødbyhavn as well as at the Hyllekrog offshore station very low numbers were registered in both baseline years in autumn, just as offshore in the Fehmarnbelt in 2010.

Overall, spring migration happened within a shorter time in comparison to autumn migration, and like for the Common Eider, during spring higher numbers

FEHMARNBELT BIRDS

were counted near the Lolland coast, while autumn migration occurred closer to the Fehmarn coast.

Common Scoter also migrates at night in high numbers and can be registered due to its flight vocalisations. For these night-time acoustic observations an inland and a harbour location was used both at Puttgarden and Rødbyhavn. During 2009, very few Scoter migration nights at Puttgarden were picked up at Puttgarden and Rødbyhavn. On 29/30 September 2009 some 69 individuals/h were registered during daytime observations and at night some 14 calls/h were registered at the acoustic onshore station, but none at the acoustic inland station. On October 5, 2009 some 12 calls/h were registered at Puttgarden inland station, and none at the onshore station, but Common Scoter daytime migration occurred with 175 individuals/h during the following day. During these events, no Common Scoters have been visually registered offshore or at Rødbyhavn, but calling Common Scoters were registered at the Rødbyhavn inland acoustic station during October 20 and November 13. During 2010 the night time acoustic observations were more frequent, often more than 20 calls/h were registered from mid-March to mid-April at all onshore stations. During autumn fewer Common Scoters were recorded during acoustic observations (Figure 1.5). During spring 2010 the number of calls at Puttgarden was considerably higher inland (n=2,258) compared to the number of calls at the harbour station (n=624). At Lolland the number of calls was high at both stations (harbour: n=4,838; inland: n=3,680).

The high numbers of flight calls at the inland locations support the common perception, that Common Scoter may well migrate over land during night-time, while during daytime this species is only seen flying over water.

FEHMARNBELT BIRDS

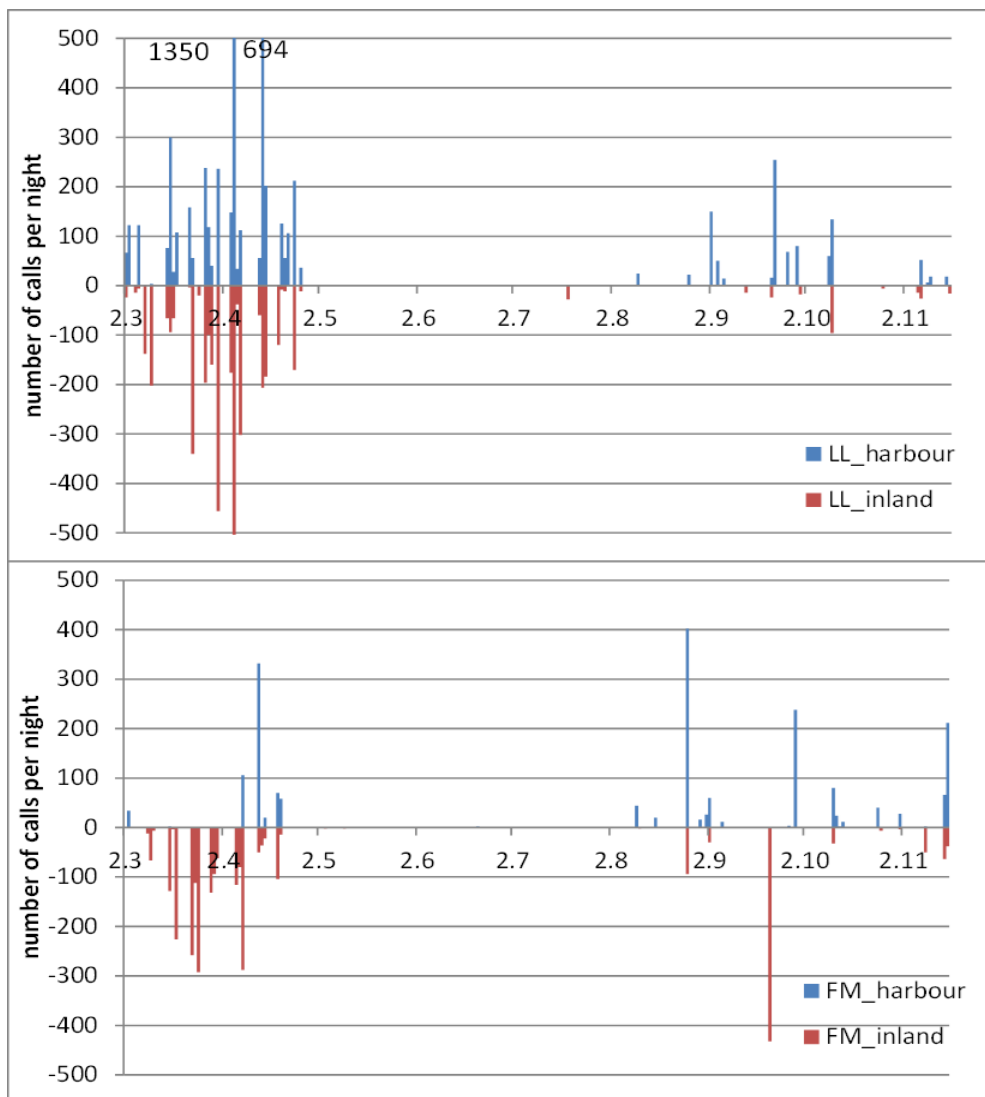

Figure 1.5 Number of night calls of Common Scoter in 2010 at Lolland (LL, harbour and inland) and Fehmarn (FM, harbour and inland). Total sums per night.

Flight directions

The flight directions of Common Scoter at both onshore stations were mostly coast-parallel during 2009 and 2010 (Figure 1.6, Figure 1.7). As for Common Eider, the flight directions were in spring both NW(-W) and SE(-E) at Puttgarden, whereas at Rødbyhavn strictly SE. Short-distance movements may have been added to long-distance migration movements at Puttgarden, whereas at Rødbyhavn only long-distance migration movements were registered. At the Fehmarnbelt offshore station flight patterns differed from those at land. Here, easterly (NE, E, SE) directions were most common and additionally in 2009 some birds flew in NW-W directions. These results coincided with spring data of the real-time tracking by the horizontal surveillance radar for all three observed stations (chapter 4.3.2, Figure 4.31).

FEHMARNBELT BIRDS

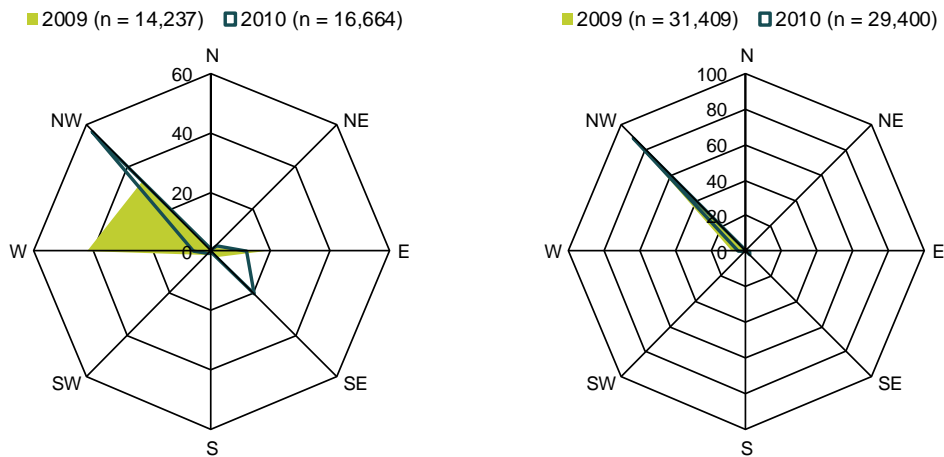

Figure 1.6 Daytime visual observations at Puttgarden onshore station: flight directions of Common Scoter in spring (left) and autumn (right); results given in %.

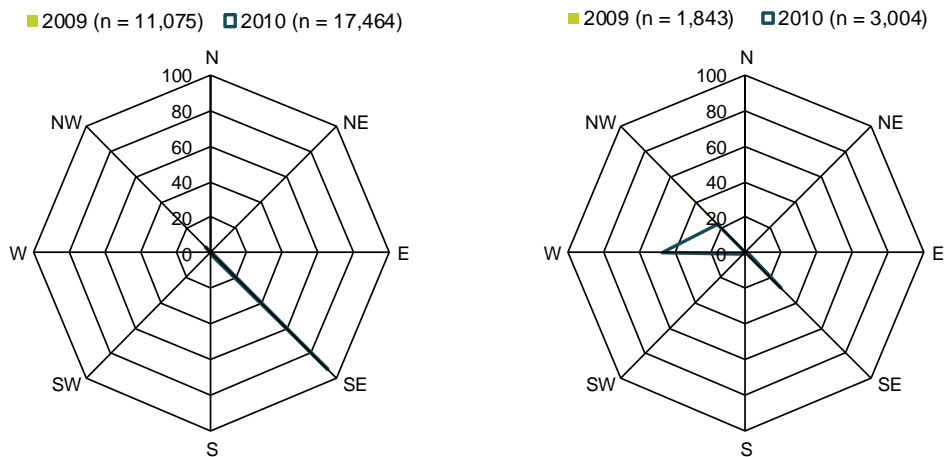

Figure 1.7 Daytime visual observations at Rødbyhavn onshore station: flight directions of Common Scoter in spring (left) and autumn (right); results given in %.

During autumn nearly all Common Scoters flew NW-W at all stations (Figure 1.6, Figure 1.7). At Rødbyhavn Common Scoter showed a similar pattern only in 2009, whereas in 2010 W and even SE directions were recorded. At the Fehmarnbelt offshore station, 50% of the Common Scoters were observed flying in W directions and about 35% were observed flying in NW directions. During autumn 2010 about 20 % of the Common Scoter were registered flying E.

These movements were sometimes opposite to the expected migration direction both in spring and autumn, and point to movements between staging areas in the Fehmarnbelt region or even more distant resting areas.

Flight altitudes

The vast majority of the Common Scoters flew below 30 m (Figure 1.8). During autumn Common Scoter seemed to fly somewhat higher than Common Eiders, regularly with 10 % to 40 % in the altitude band 30-100 m. The tracking radar recorded very few tracks of Common Scoter, most likely due to the overall lower

FEHMARNBELT BIRDS

daytime numbers, low flight altitudes and no option to identify seabirds to species level during night-time (see Appendix B.1-B.5). Species-specific results of vertical surveillance radar are not available.

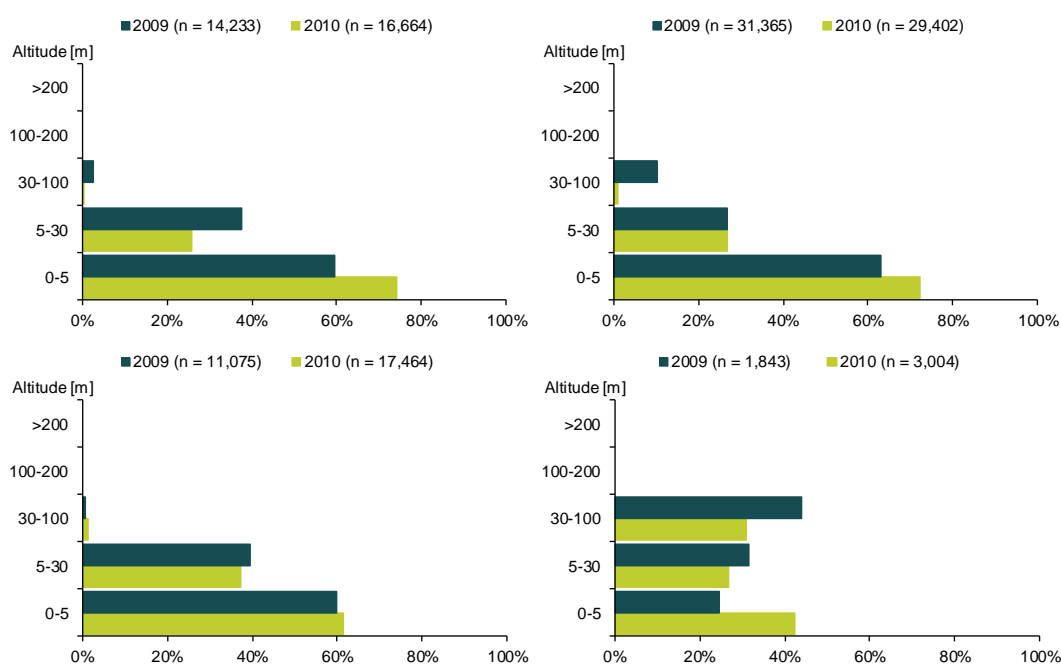

Figure 1.8 Daytime visual observations at Puttgarden onshore station (top) and Rødbyhavn onshore station (bottom): flight altitudes of Common Scoter in spring (left) and autumn (right) 2009 and 2010.

Migration dynamics

The diurnal dynamics of Common Scoters are described combining daytime and night-time observations and examples from the telemetry studies.

The daytime phenology of movements of Common Scoters varied between locations and seasons. In spring, a clear peak of morning activity was recorded at all three stations, with the largest morning peaks recorded at Lolland and at the offshore station. Also, evening peaks of spring migration were registered offshore during March as well as onshore at Lolland in April, while no clear evening peaks appeared at Fehmarn. The intensity of nocturnal calls in spring reached its maximum 3-4 hours after sunset. During moult migration the peak of activity of Common Scoters occurred in the evening, a few hours prior to sunset and during night, 4-5 hours after sunset. Later during autumn migration, the evening peaks stopped up almost completely. These findings are generally confirmed by results published, referring to a morning activity peak lasting 3-5 hours after sunrise and one during the late afternoon 2-3 hours before the sunset. An evening peak of activity of Common Scoters was recorded by visual observations e.g. at the northern tip of Rügen (Nehls et al., 1993) and in southern Finland (Bergman 1974). In the Baltic Sea the evening peak of migration has been detected during the second half of August (Nehls & Zöllick 1990). This evening peak of activity could include Common Scoters developing a nocturnal rhythm of activity prior to migration across the mainland areas of

FEHMARNBELT BIRDS

northeast Europe in spring, or just finishing their nocturnal flight across mainland areas in autumn.

Satellite telemetry of movements of Common Scoters, carried out during the baseline investigations, provided evidence that birds do cross land during daytime (Figure 1.9). They also showed that individuals do fly over water during night time after civil twilights, in this case right before crossing the continent between White and Baltic Seas (Figure 1.10). Nocturnal flights of Common Scoters over large masses of land were not documented by satellite telemetry. However, these events have been reported earlier by radar observations and nocturnal recordings (Bergman 1974, Busche et al., 1993), and are confirmed in the baseline night-time acoustic observations. Besides, results from moult migration of Common Scoters in the Eastern Baltic, including tracking radar observations, have showed that large numbers of Common Scoters migrate over land at high altitudes (1,000-2,500 m) on a broad front when traveling from the White Sea to the Baltic Sea (Zhalakevicius, 1978; Kumari, 1979; Kokhanov, 1983).

Overall, the observation results suggest that moving activities preceding larger migration bouts may occur during late afternoon before a night-time overland flight takes place.

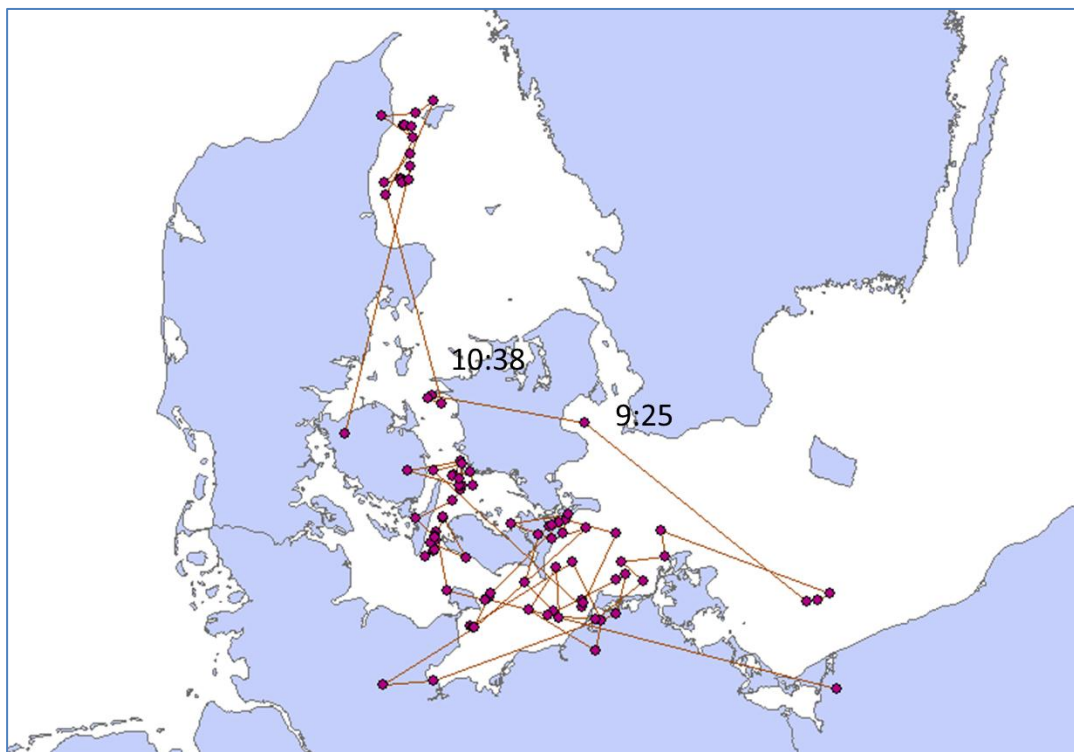

Figure 1.9 Flight paths of one satellite-tagged Common Scoter during September 6, 2010, time in UTC. The flight between 09:25h to 10:38h occurs daytime over land.

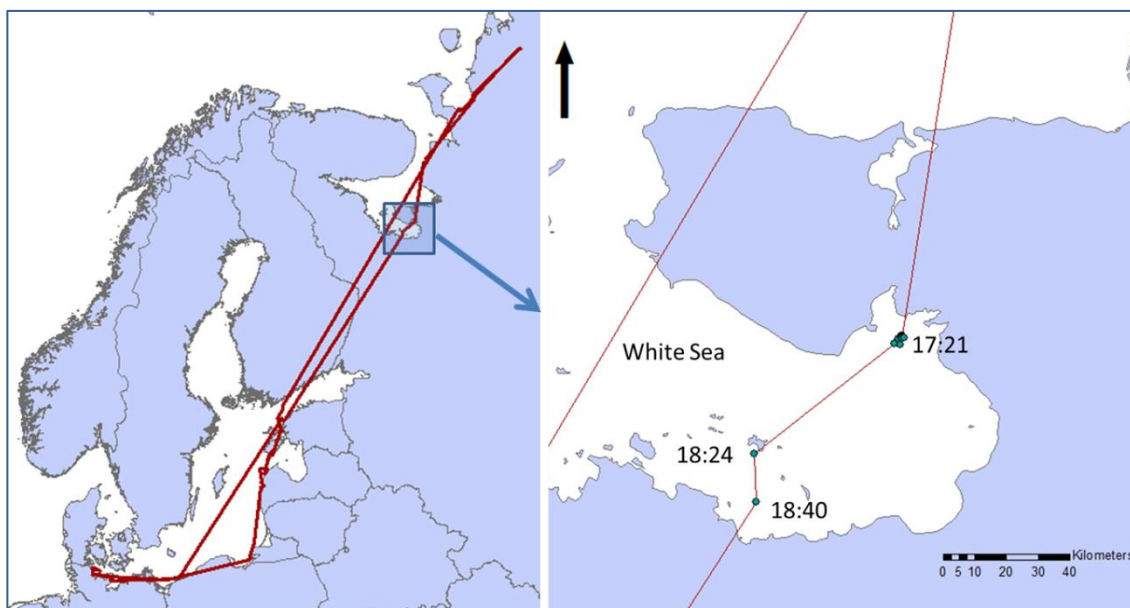

Figure 1.10 Evening/night flight of one satellite-tagged Common Scoter, 3 September 2010 across water. Time is UTC. Civil twilights are 17:32 and 01:27. Four days after this flight the bird was located at the western part of Gulf of Finland, Baltic Sea.

1.2.2 Divers, grebes, mergansers and auks

Divers, grebes, mergansers and auks present four species groups with 13 species that show some similarities with regard to migratory behaviour, as they are all known to migrate along water and cross land only if necessary. In addition, all are piscivorous and most of them are known to show a considerable sensitivity to disturbances (e.g. Garthe and Hüppop 2004, Dierschke et al., 2006, Petersen et al., 2006, Desholm 2009).

Phenology and intensity

With 11,569 individuals registered in 2009 and 12,084 in 2010, these species groups represented only some 0.6 % of all visually counted birds both years.

Of the **divers** (3,429 in 2009, 3,576 in 2010), Red- and Black-throated Diver (*Gavia stellata*, *Gavia arctica*) were registered with equal numbers in 2009 (794, 786), but another 1,841 individuals were not identified to species level. In 2010 Red-throated Divers (508) have been seen more often than Black-throated Divers (340), but additionally 2,726 divers could not be determined to species level.

In both years some 80 % of the registrations were obtained during spring. Most registrations during spring occurred at Rødbyhavn and offshore in the Fehmarnbelt between mid-April and mid-May. Additionally, in spring 2010 divers were recorded at the central Fehmarnbelt offshore station between mid-March until the end of March. During autumn most registrations were from the Puttgarden location and again offshore from late September until November. Both diver species are known to winter in the Baltic Sea (Mendel et al., 2008, Skov et al., in press).

FEHMARNBELT BIRDS

Of the **grebes** (1,948 in 2009, 2,160 in 2010), some 66 % of all individuals were registered during the spring seasons (67.3 % in 2009, 65.6 % in 2010). Great Crested Grebe (*Podiceps cristatus*) was the most numerous overall (2009: 1,305 = 67 %, 2010: 1,316 = 54 %). However, during autumn, this species and the Red-necked Grebe (*Podiceps grisegena*) appeared in comparable numbers. Slavonian Grebe (*Podiceps auritus*) was registered in very low numbers (2009: 46, 2010: 2), and Little Grebe (*Tachybaptus ruficollis*) only during night acoustic observations which may be allocated to breeding individuals. Both the Great Crested Grebe and Red-necked Grebe breed on Fehmarn (58 and 141 breeding pairs according to Berndt et al., 2005), as well as in the nearby German and Danish regions. Thus, most of the birds registered would be migrants or wintering birds. Grebes were visually recorded in small numbers at all observation stations and during the entire observation period. Most movements during spring were spotted from the Puttgarden location and – in 2010 – from the central Fehmarnbelt offshore station, whereas during autumn most birds were seen both from Puttgarden and Rødbyhavn from late September to November.

Among the **mergansers**, more than 95 % of the overall individuals counted (2009: 5,868, 2010: 5,936) belonged to Red-breasted Merganser (*Mergus serrator*) (2009: 5,689 = 97 %, 2010: 5,684 = 96 %). Most Red-breasted Mergansers were registered during spring. Red-breasted Merganser breeds on Fehmarn (49 breeding pairs – Berndt et al., 2005) and most likely in the nearby German and Danish regions. Thus, many of the registered birds would be migrants *en route* from their Northern breeding grounds to the Netherlands and further on towards the French Channel or Atlantic coast. However, many individuals also stay in the Baltic during winter (Mendel et al., 2008). Mergansers were spotted at both land stations during the entire spring migration period (end of February until end of May) and during autumn migration period between end of September until mid-November. At the central Fehmarnbelt offshore station only few migrating mergansers were spotted.

In 2009 a total of 294 **auks** were registered. Of these 44 were Common Guillemots (*Uria aalge*), 136 Razorbills (*Alca torda*) and 98 individuals were not identified to species level. As a rare occurrence, a total of 16 Black Guillemots (*Cephus grille*) were also seen. In 2010 the number of registered auks was 388, of these 46 were Common Guillemots, 198 Razorbills, 4 Black Guillemots and 140 were not identified to species level. During spring 2009, single sightings added up to some 30 individuals per location. Numbers at the land stations were slightly higher during autumn 2009, and considerably higher at the offshore locations Fehmarnbelt and Hyllekrog, where 92 and 46 auks were registered from mid-October to mid-November. During both migration seasons in 2010 the highest numbers of migrating auks were again registered at the offshore station, with most auks registered during spring (292) while numbers during autumn were lower (96). Thus, auks showed higher migration intensities at the offshore compared to the onshore locations, but whether migration is generally higher during spring or autumn season cannot be estimated from the results of the two baseline years.

Flight directions

Almost all Auks move or migrate along the Fehmarnbelt in E and SE directions during spring and W and NW during autumn. These visual observations can be confirmed by results of real-time tracking by the horizontal surveillance radar where e.g. divers show at least during spring significant coast-parallel migration

FEHMARNBELT BIRDS

directions (4.3.2). During spring at the Puttgarden station a bimodal distribution of flight directions of divers, grebes and mergansers was registered with about half of the birds going E/SE and the other half W/NW along the Fehmarnbelt coastline. This may suggest that local / short-distance movements were involved for these species at least during early spring. Results from the 'Superfledermaus' (tracking mode) are quite sparse for these species, but in spring 2009 results for mergansers and Black-throated diver exist. Mergansers' mean flight direction at Rødbyhavn was S (n=11 tracks, 29 ind.) and Black-throated Divers' mean flight direction was SSE (n=5 tracks, 7 ind.) (see Appendix B.1). For other species or seasons too few tracks exist. During 2010, none of these species could be tracked.

During autumn divers at Puttgarden used NW directions during both baseline years (Figure 1.11). Grebes used N-NW and SE directions at the land stations in both years. Mergansers used NW directions at the land stations in both years as well. At the offshore stations divers and merganser were spotted flying SE or W, grebes show no clear pattern in flight directions.

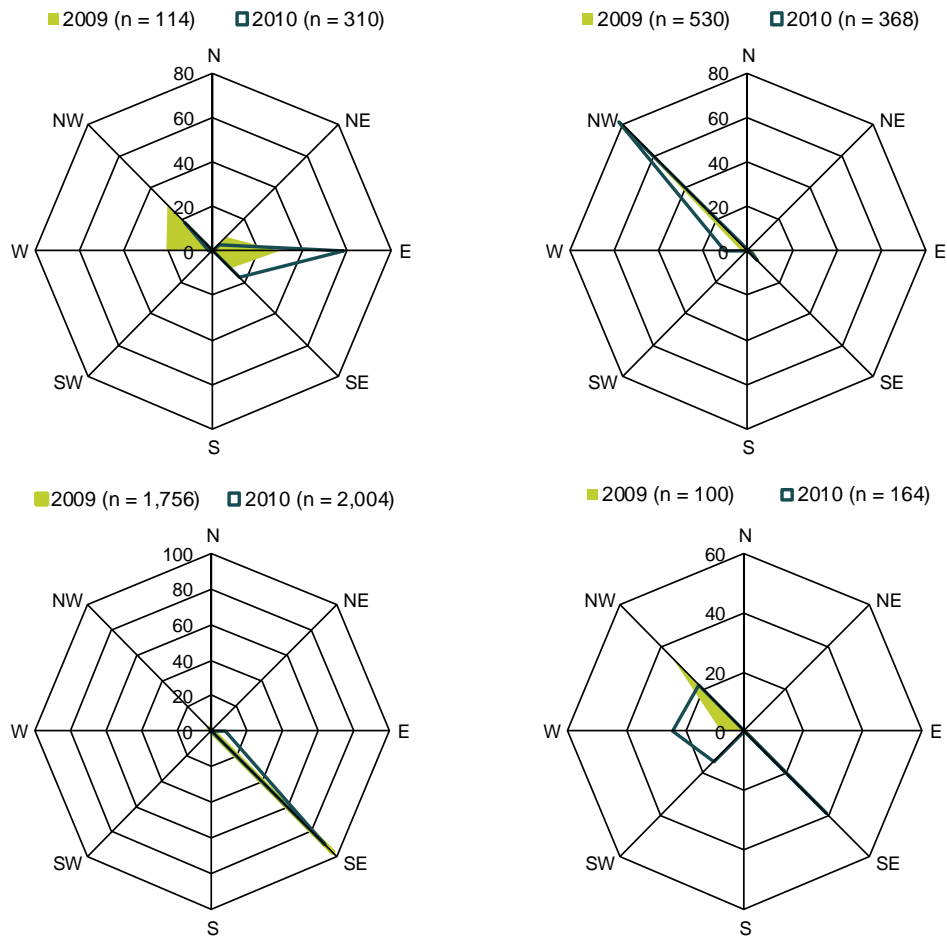

Figure 1.11 Daytime visual observations at Puttgarden (top) and Rødbyhavn (bottom) onshore station: flight directions of divers in spring (left) and autumn (right); results given in %.

Migration directions of auks were during all observations in all seasons mainly NW and SE parallel to the coast (Figure 1.12). Additionally, during autumn some auks have a SW orientation.

FEHMARNBELT BIRDS

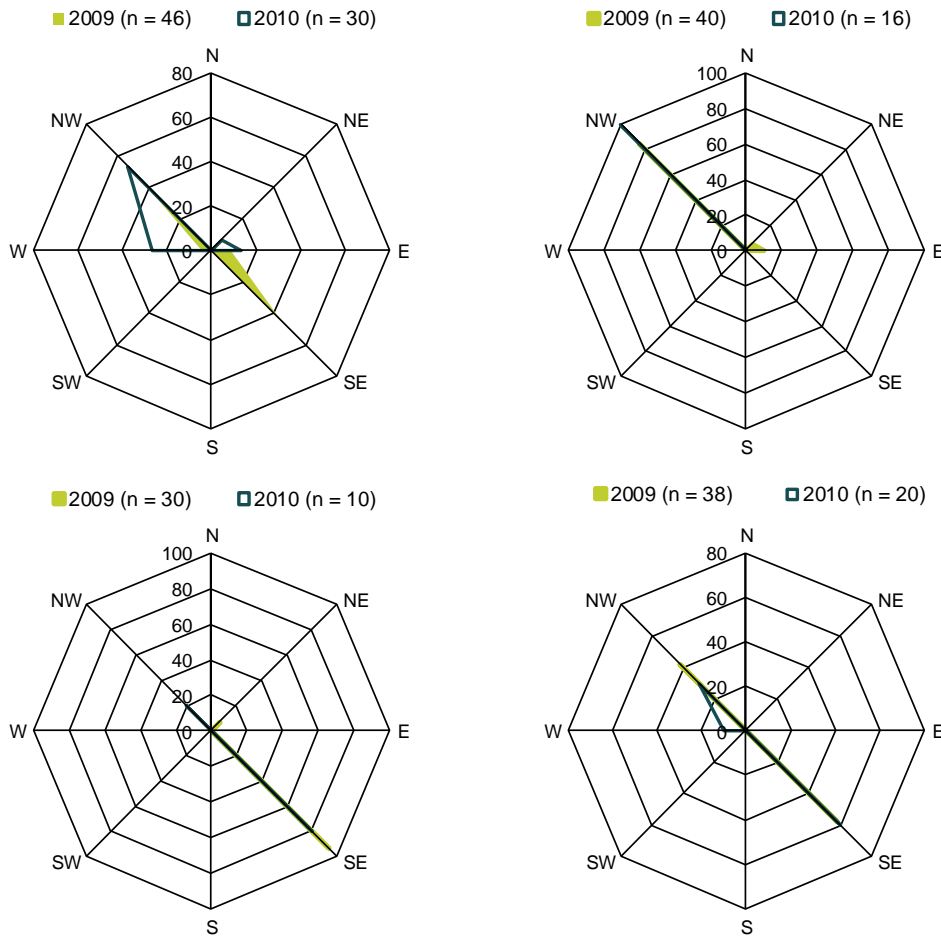

Figure 1.12 Daytime visual observations at Puttgarden (top) and Rødbyhavn (bottom) onshore station: flight directions of auks in spring (left) and autumn (right); results given in %.

Flight altitudes

Flight altitudes of almost all divers, grebes, mergansers and auks species are below 30 m, only for some stations and species use of the altitude band between 30 and 100 m was registered. During visual observations the majority of grebes were registered below 30 m.

For the divers (Figure 1.13), most of them move below 30 m. However, medium numbers were also registered at the 30-100 m altitude category. At Puttgarden during autumn 2009, this applied for 50 % of the 522 individuals. At Rødbyhavn, this applied even for 60 % of the 2,004 individuals during spring 2010. During spring 2009 the 'Superfledermaus' also tracked divers at some higher elevations at Rødbyhavn with Black-throated divers at 226 m (5 tracks, 7 individuals) and unidentified divers at 184 m (2 tracks, 5 individuals) (see Appendix B.1). These findings are in contrast to e.g. Dierschke (2002), who for the North Sea near Helgoland found that the majority (91.8 %) of Red-throated Divers flew below 50 m. However, it can be assumed that high-flying divers may simply be missed by visual observations.

FEHMARNBELT BIRDS



Figure 1.13 Daytime visual observations at Puttgarden onshore station (top) and Rødbyhavn onshore station (bottom): flight altitudes of diver in spring (left) and autumn (right) 2009 and 2010.

Mergansers were mostly spotted in the altitude band below 30 m, but at Rødbyhavn between 10 and 20 % were registered in the altitude band between 30 and 100 m in both years and seasons. For Red-breasted Merganser a few tracks from the 'Superfledermaus' recorded average altitudes of 64 m (4 tracks, 15 ind.) during spring 2009 and 137 m (2 tracks, 9 ind.) during autumn 2009 (see Appendix B.3).

Auks were mainly registered in very low altitudes; some 98 % of all registered auks in the two baseline years flew below 10 m (Figure 1.14). The highest recorded altitude for auks was 50 m, these two birds were seen in spring 2009.

FEHMARNBELT BIRDS

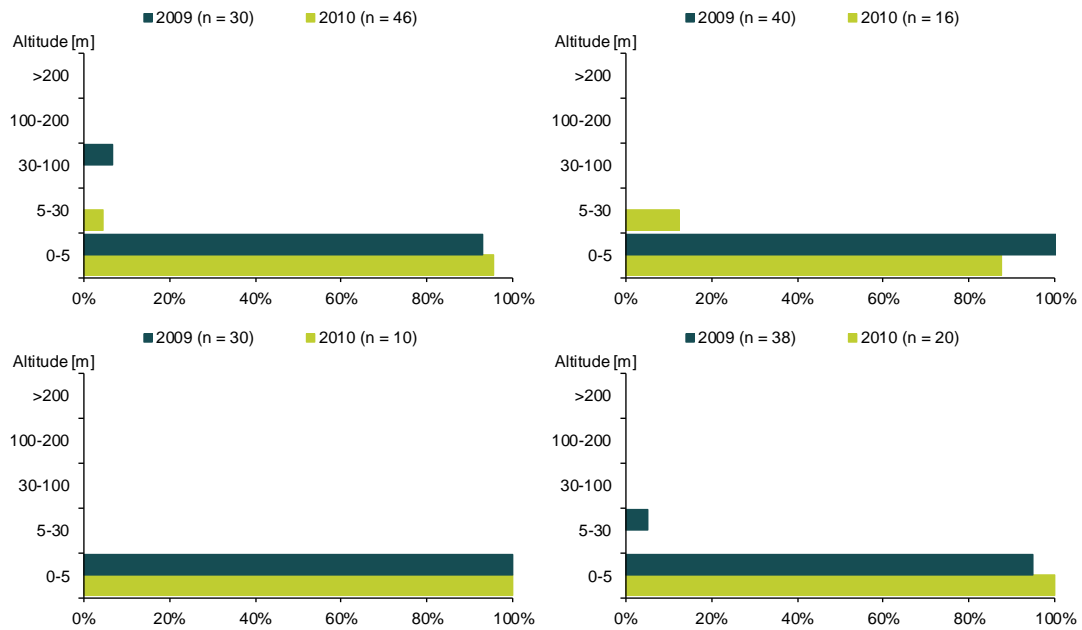

Figure 1.14 Daytime visual observations at Puttgarden onshore station (top) and Rødbyhavn onshore station (bottom): flight altitudes of auks in spring (left) and autumn (right) 2009 and 2010.

1.2.3 Terns

Terns, with five species occurring, represented less than 1 % of all visually observed birds (2009: 0.5 %; 2010: 0.6 %). Most of them were either Common or Arctic Tern (*Sterna hirundo*, *Sterna parasidaea*), less than 20% were Sandwich Tern (*Sterna sandvicensis*) and a few other species. The earliest terns were registered around March 20 in both years and the latest terns left the area before mid-October. A distinct migration peak was registered in both baseline years in the last days of April (see Appendix A.2.11). During spring terns movements had an easterly (SE-NE) orientation, during autumn birds flew in SW (some NW) directions (see Appendix A.4.2). Thus, most terns flew parallel to the coast. Registered flight altitudes were mainly below 30 m (see Appendix A.5.2).

Ducks, here dabbling and diving ducks, represent a mixture between type 1 and type 2 migration, and will be discussed under type 2 species (see below).

1.2.4 Summary

For type 1 species the Fehmarnbelt simply by way of its geographic position represents a very important migration corridor. During daylight, waterbirds flying parallel to the coast are the most abundant migratory bird species group with Common Eider as the most common species. For several species Fehmarnbelt represents a very important migration route used by high proportions of their biogeographic populations. Of these species, most likely auks have the highest dependency of migration over water. *Gavia* divers and seaducks are mostly confined to migrate over sea. During daytime at Fehmarnbelt these species have not been observed to migrate over land. However, *Gavia* divers breed at inland locations and seaducks cross land, e.g. Common Eider over Schleswig-Holstein towards the Wadden Sea or Common Scoters over Skåne, Sweden to and from the breeding regions. In addition Common Scoters are known to migrate over land during night-time, which has

FEHMARNBELT BIRDS

also been recorded in the Fehmarnbelt region. Therefore, crossing over land is a regular event during these species' migration. Other species, like gulls and terns, have also been registered to migrate over land during the baseline years 2009 and 2010.

Low flight altitudes are very common for the type 1 species, in particular over water, which is even more prominent during headwind situations (chapters 4.4.1 and 5.3.1; Dierschke and Daniels 2003). Flight directions of supposedly migrating individuals and flocks were mainly in the expected direction either towards breeding or wintering grounds. Seaducks in particular migrated close to the coast in spring at Lolland and in autumn at Fehmarn. While a leading-line effect of the coasts exists for these species, the actual distance to the coast is also influenced by the wind, where winds blowing towards onshore "push" birds closer to the coast (chapter 5.1.3). The pelagic species, with overall lower numbers, did not show that leading line effect and were more evenly distributed.

For type 1 species, a potential barrier effect of e.g. bridge structures exists.

1.3 Waterbirds less dependent to migrate over water (type 2 species)

Migrating over sea may be compromised by the need to minimise the migratory route of a species, especially if migration covers long distances. For example arctic breeding waterbirds such as swans, geese, ducks and waders may conduct non-stop flights over distances of more than 1,000 km and are engaged in flights lasting several days (e.g. Battley et al., 2001, Green 2004, van der Graaf et al., 2006, Scott and Scheiffarth 2009, Shamoun-Baranes et al., 2010). These species will migrate over water as long as it fits their overall migration route but are prepared for long flights over land. They will also make use of favourable wind conditions and adapt migration timing accordingly (Green 2004). Their migration routes are exemplified as a green solid line in Figure 1.1. These species may fly large distances during good migration conditions, and are thus less dependent on stop-over sites, and they also fly during day- and night-time. However, their migration routes do show some dependency on weather. In particular wind speed and direction may shift migration routes. Therefore these birds may or may not directly overfly the Fehmarnbelt area.

For some of the species high migration intensities were registered during the baseline years 2009 and 2010. It has to be assumed, however, that many of these observations were only made by chance when large flocks of birds were registered during good observation conditions or picked up by the tracking radar. Consequently it has to be also assumed, that considerable numbers and most likely some species, in particular wader species, were not registered as they were either not spotted during their fast flight at high altitudes overhead or did not exactly cross one of the field stations.

1.3.1 Swans, dabbling and diving ducks

Swans represented some 0.2 % of all visually counted birds in both years, with most registrations belonging to Mute Swan (*Cygnus olor*), and a few to Whooper and Bewick's Swan (*Cygnus Cygnus*, *Cygnus columbianus bewickii*).

FEHMARNBELT BIRDS

Phenology and intensity

As this species group uses the larger region for overwintering, moult and stop-over, it was registered throughout the year at all stations. Most birds were registered at Rødbyhavn, both in spring and autumn. Distinct migration peaks occurred at Rødbyhavn between mid-May and beginning of June (see Appendix A.2.5) with some 15 migrating individuals per hour. During autumn no distinct migration peaks were recorded.

Flight directions

Flight directions of swans showed no clear tendency, but NW directions were both used during spring and autumn (Figure 1.15). During spring NE directions were used as well. At the offshore locations, the migration pattern was variable, but E to S directions were used regularly (see Appendix A.4.2).

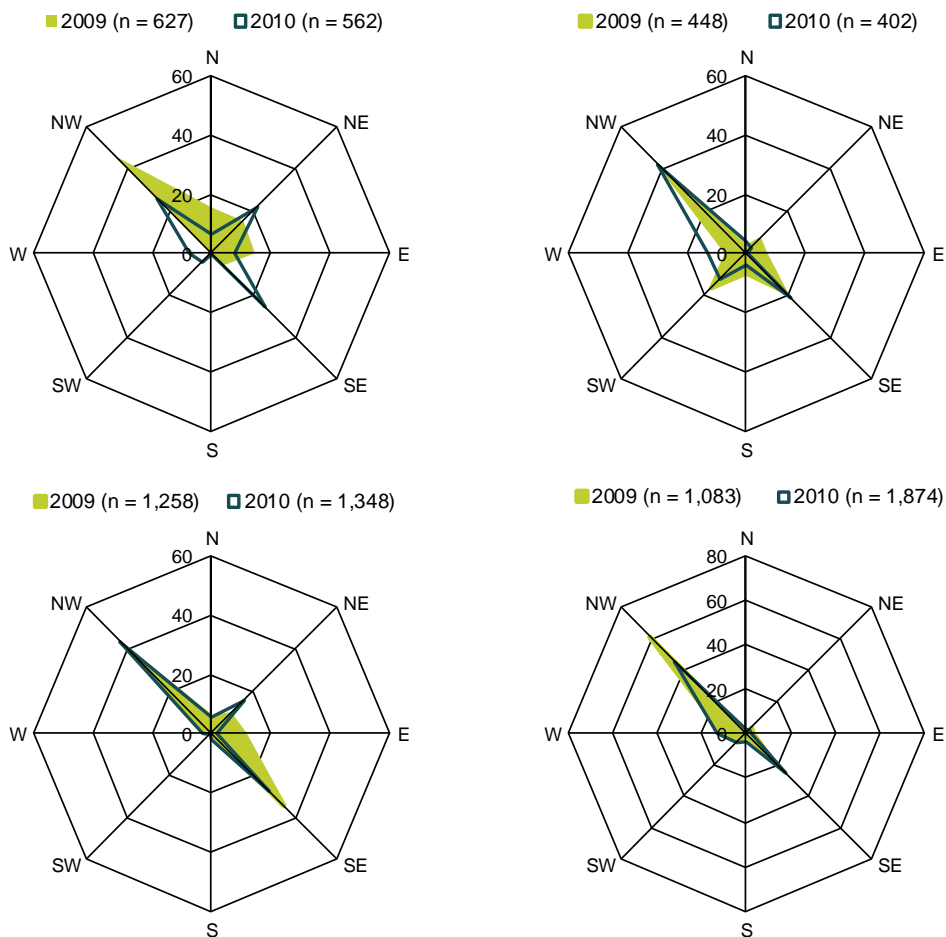

Figure 1.15 Daytime visual observations at Puttgarden (top) and Rødbyhavn (bottom) onshore station: flight directions of swans in spring (left) and autumn (right); results given in %.

FEHMARNBELT BIRDS

Flight altitudes

Flight altitudes were mainly low (< 30 m) (Figure 1.16). Only a small fraction regularly used the altitude band 30-100 m except for autumn 2009 at Rødbyhavn, when some 40 % of the registered swans used the altitude band between 30 and 100 m (see Appendix A.5.2).



Figure 1.16 Daytime visual observations at Puttgarden onshore station (top) and Rødbyhavn onshore station (bottom): flight altitudes of swans in spring (left) and autumn (right) 2009 and 2010.

Dabbling ducks and **diving ducks** represent only a small fraction of all visually observed birds with about 1 % in both baseline years, representing ten different species. While they prefer to migrate over water, they also show large staging aggregations at inland sites, used as stop-over or wintering habitats. Thus, they belong to the type 2 species as well. Spring migration was not very distinct during the baseline years, but autumn migration yielded intensities of some 100 ind. /hour at all stations, even offshore. At offshore locations in 2009 the autumn migration period was quite extensive starting already end of July. At the onshore locations migration began end of August (see Appendix A.2.7). Flight directions were bimodal (SE/NW) during spring and strict W/NW during autumn (see Appendix A.4.2). Flight altitudes were mainly below 30 m, but some 20 % of the birds observed at the different stations used the altitude band between 30 and 100 m as well (see Appendix A.5.2). It can be assumed, that in particular during spring short-distance movements of ducks are included in the observations. 113 tracks of 729 unidentified ducks had been tracked by the "Superfledermaus" in spring 2009 with a mean flight altitude of 43 m. Even though these may represent a mixture of duck species, these results generally confirm the altitude distribution as registered by visual observations. Mean flight direction of these tracks was SE, also in line with visual observations.

1.3.2 Geese

In 2009, 9.2 % and in 2010, 9.7 % of all visual observed birds were **geese**. Spring migration of geese was most obvious at Rødbyhavn, where most birds were registered during May. Autumn migration proceeded during October to early November, most obvious at both land stations and less at the offshore station (see Appendix A.2.6). Migration directions of geese were variable with more easterly (NE-SE) orientation during spring and westerly during autumn (NW-SW) (see Appendix A.4.3). Altitude distribution is variable as well, but most registrations were between 30 and 200 m (see Appendix A.5.3).

As opposed to Barnacle and Brent Geese (*Branta leucopsis*, *Branta bernicla*) the Greylag Goose (*Anser anser*) exhibits a migration behaviour more fitting the type 3 species, as it mainly crosses the Fehmarnbelt at the link (e.g. chapter 4.3.2, Table 4.19).

Barnacle Goose

Phenology and intensity

Of a total of six goose species, about 50 % of the individuals belonged to Barnacle Geese (2009: 48.6 %; 2010: 53.4 %), thus this species is described in more detail. During spring nearly all Barnacle Geese were registered at Rødbyhavn. During autumn, high numbers were registered both at Puttgarden and Rødbyhavn, with the highest number in Rødbyhavn in 2009 and the highest in Puttgarden in 2010. Thus, Barnacle goose migration seem to be quite variable within the region as the Fehmarnbelt is located within the southern range of their flyway between the wintering areas at the Wadden Sea and the stop-over sites at the Baltic Sea coast (chapter 5.3.2, Figure 5.33). During spring 2009 there was one distinct peak migration day on May 7 at both land observation stations.

During night-time acoustic observations calls of Barnacle Geese were registered most frequently at Rødbyhavn, both during spring and autumn migration. Here, numbers of calls did not differ much between the harbour (spring: n=11,850; autumn: n=5,124) and inland (spring: n=11,284; autumn: n=4,578) location. This supporting that their migration routes are independent of coastlines. During spring 2010 high migration intensities were recorded in the nights of May 10 and May 17.

Analyses of the migration intensity of Barnacle Geese compared to weather conditions showed that they may migrate during inclement and inadequate weather conditions (chapter 5.3.2, Green 2004), but mostly make use of tailwind periods. However, Barnacle Geese are also known to adapt their migration schedule to feeding conditions on their route and stepping stones, following the appearance of fresh grass (concept of the "green wave": van der Graaf et al., 2006, Drent et al., 2007). During autumn migration north-easterly winds and wind speed play a role for migration intensity of Barnacle Goose (chapter 5.3.2).

Flight directions

Barnacle Geese were registered by visual observations during spring in more easterly directions and during autumn in more southerly/westerly directions (Figure 1.17, Figure 1.18).

FEHMARNBELT BIRDS

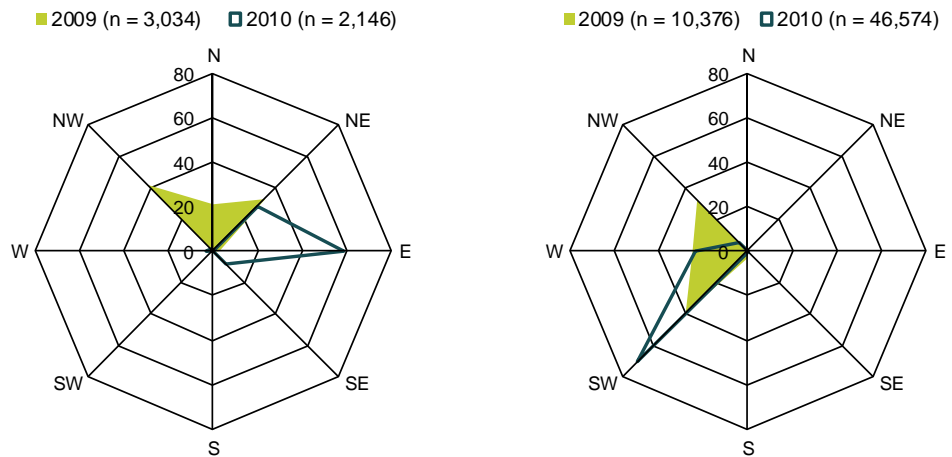

Figure 1.17 Daytime visual observations at Puttgarden onshore station: flight directions of Barnacle Goose in spring (left) and autumn (right); results given in %.

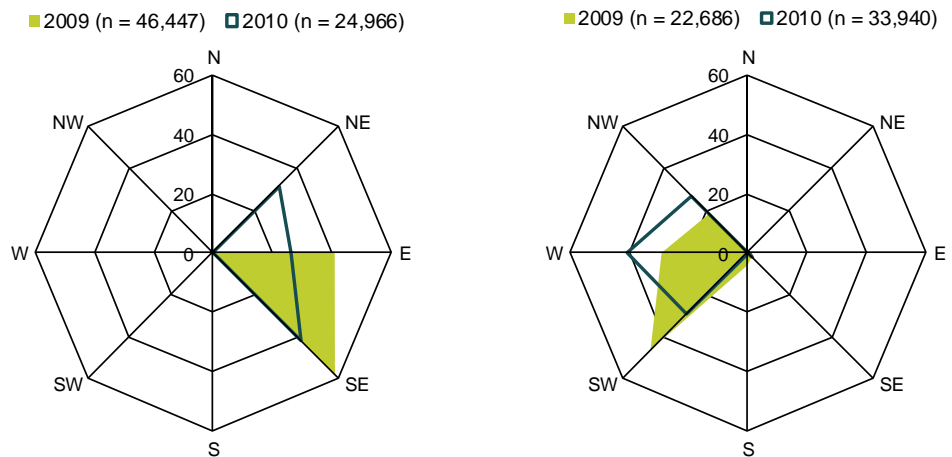

Figure 1.18 Daytime visual observations at Rødbyhavn onshore station: flight directions of Barnacle Goose in spring (left) and autumn (right); results given in %.

Results of real-time tracking by the horizontal surveillance radar show that flight directions may vary within some limits. Sometimes Barnacle Goose followed the coast, sometimes not (chapter 4.3.2, Figure 4.34, Figure 4.35 and Table 4.19). As typical long-distance migrants, Barnacle Goose may follow a predestined direction independent of topography of coastlines and other features. However, depending on wind direction and speed, their flight might be coast-parallel by chance. Barnacles were also tracked by the "Superfledermaus" during autumn 2010 in larger numbers (16 tracks, 1,940 ind.) with a western mean flight direction.

Flight altitudes

During visual observations, Barnacle Geese were registered in all altitude bands, but most of them used the altitude band 30-100 m (Figure 1.19).

Flight altitudes of Barnacle Goose seem not to change when migrating flocks leave or arrive at the coast. I.e. they are unaffected by crossing the coastline, as results from the "Superfledermaus" indicate (chapter 4.6.1).

FEHMARNBELT BIRDS



Figure 1.19 Daytime visual observations at Puttgarden onshore station (top) and Rødbyhavn onshore station (bottom): flight altitudes of Barnacle Goose in spring (left) and autumn (right) 2009 and 2010.

1.3.3 Waders

Typical representatives for waterbirds less reliant on migrating over water are **waders**. They include 23 species (here excluding species with less than 10 sightings), representing some 4 % of all visually observed birds (2009: 4.6 %; 2010: 4.3 %). Among the more numerous species registered were Grey Plover (*Pluvialis squatarola*), Lapwing (*Vanellus vanellus*), Red Knot (*Calidris canutus*), Dunlin (*Calidris alpina*), Bar-tailed Godwit (*Limosa lapponica*) and Eurasian Curlew (*Numenius arquata*), plus considerable numbers passing unidentified to species level.

Waders also migrate during night-time, as recorded by acoustic observations. During 2009 Golden Plover (*Pluvialis apricaria*) was recorded most frequently, in 2010 Eurasian Curlew. Most Golden Plovers were registered at the Puttgarden inland location during September 2009, whereas at the other locations only a few Golden Plovers were recorded. In 2010 night-time migration of Eurasian Curlew was registered in higher numbers during spring than during autumn. At Rødbyhavn Curlew calling intensities during spring did not differ between harbour (n=2,356) and inland (n=2,770) locations, whereas at Puttgarden number of migration calls at the inland (n=2,928) location was two times higher than at the harbour (n=1,508) (Chapter 5.2.3, Figure 5.5).

Phenology and intensity

Migration peaks registered by visual observations occurred in both years, most obvious at Rødbyhavn during spring (late May to early June) with more than 800 migrating birds per hour in both years (see Appendix A.2.13). During autumn no distinct migration peaks occurred, but waders migrated in low numbers throughout the entire season and were registered at all observation locations.

FEHMARNBELT BIRDS

Flight directions

Migration directions are heterogeneous when few birds are involved, but show clear preferences in case of high numbers, when birds accomplish large-distance flights and do not depend on the coastline (Figure 1.20, Figure 1.21).

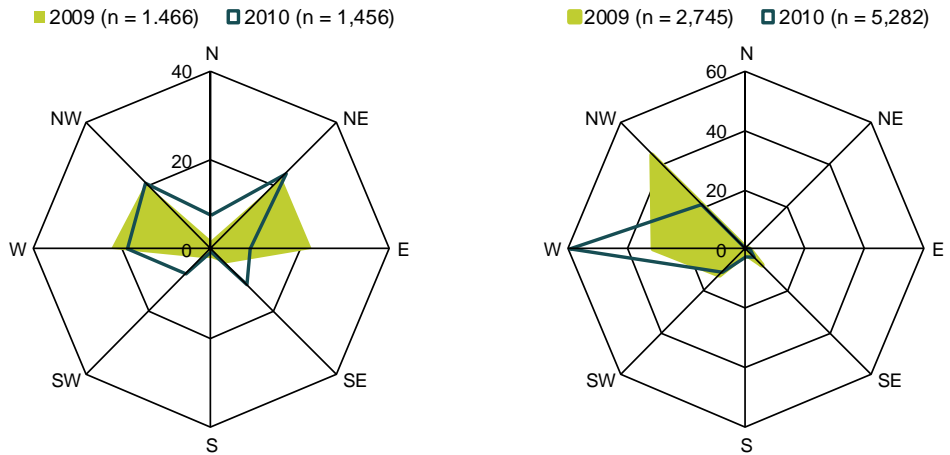

Figure 1.20 Daytime visual observations at Puttgarden onshore station: flight directions of waders in spring (left) and autumn (right); results given in %.

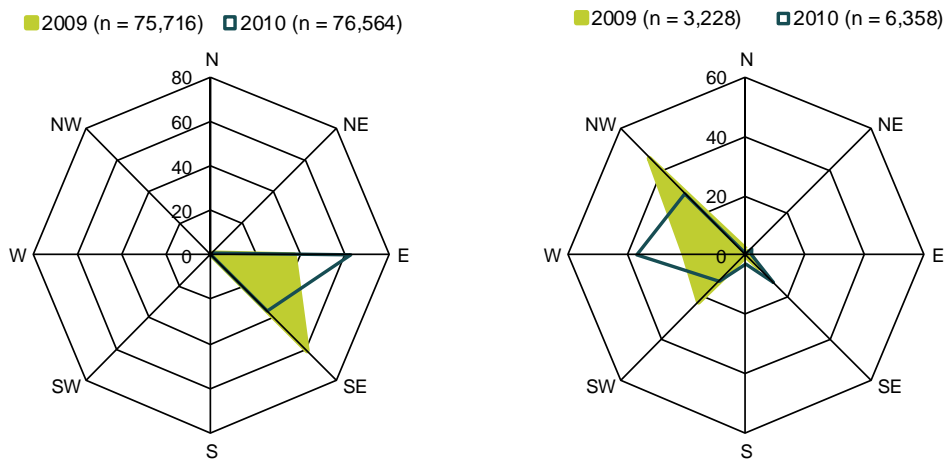

Figure 1.21 Daytime visual observations at Rødbyhavn onshore station: flight directions of waders in spring (left) and autumn (right); results given in %.

Flight altitudes

As some waders might stop-over in the Fehmarnbelt area, flight altitudes are heterogeneous with birds flying both in low and high altitude bands (Figure 1.22).

FEHMARNBELT BIRDS



Figure 1.22 Daytime visual observations at Puttgarden onshore station (top) and Rødbyhavn onshore station (bottom): flight altitudes of waders in spring (left) and autumn (right) 2009 and 2010.

1.3.4 Gulls

About 2 % of all visually observed birds were **gulls**, including seven species (2009: 2.3 %; 2010: 1.7 %). During both baseline years Black-headed Gull (*Larus ridibundus*) was the most common species (2009: n=14,345; 2010: n=12,460). Most **gull species** except for **Little Gull** (*Larus minutus*) (see below) are present in the Fehmarnbelt area throughout the year. In 2009 some peaks were recorded during spring. In the period between mid-August and end of September migration peaks occurred, most distinct at Puttgarden (see Appendix A.2.10).

Results of real-time tracking by the horizontal surveillance radar revealed that at both onshore stations gulls are attracted by the harbour and the harbour wall and other structures that are used for roosting. Sometimes they are responding on passing fishing trawlers. A high number of short-distance movements between roosting and feeding places were tracked with the radar and cannot be discerned from e.g. migration behaviour. Therefore, high numbers of registrations of local individuals result in a considerably variation of all flight aspects.

Little Gull

Phenology and intensity

Especially migration of **Little Gull** is distinct and to a large extent dependent on the marine environment. Yet, large aggregations are also known to use freshwater lakes for feeding (Koop 1985). Little Gulls were the second most common gull species registered in 2009 (n=8,790) and the third most common in 2010 (n=6,318). During the baseline years two distinct migration events of Little Gulls were registered, in 2009 at the offshore Fehmarnbelt station between

FEHMARNBELT BIRDS

April 19 and May 2 and in autumn 2010 at Puttgarden between September 28 and October 1, both with some 60 birds per hour (see Appendix A.2.10).

Flight directions

During spring Little Gulls migrated in easterly directions (SE-NE); during autumn SW (-NW) directions were used (Figure 1.23, Figure 1.24).

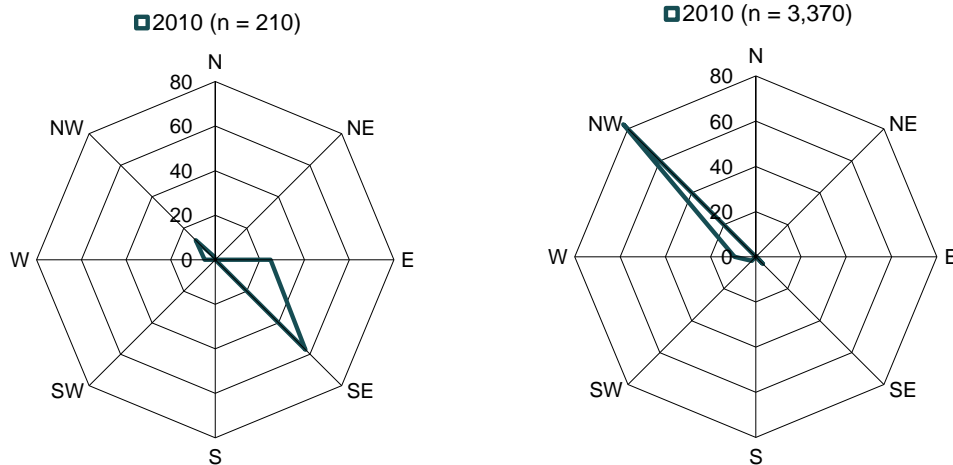

Figure 1.23 Daytime visual observations at Puttgarden onshore station: flight directions of Little Gull in spring (left) and autumn (right); results given in %.

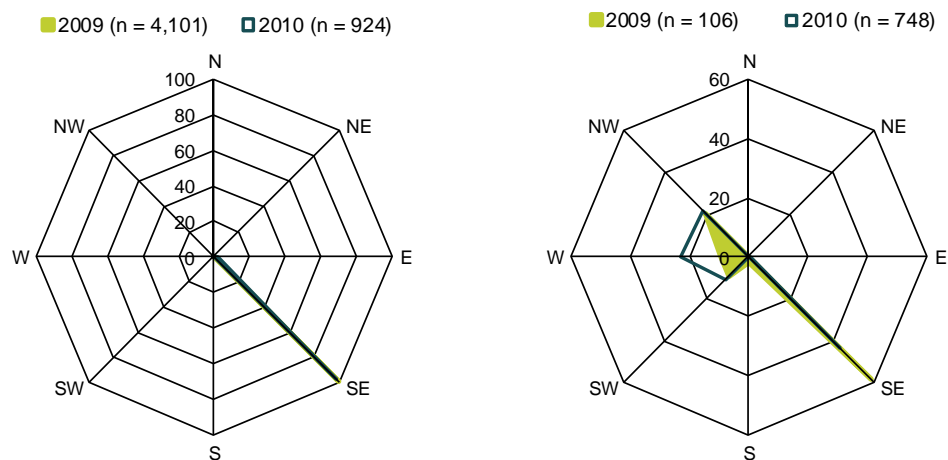

Figure 1.24 Daytime visual observations at Rødbyhavn onshore station: flight directions of Little Gull in spring (left) and autumn (right); results given in %.

Flight altitudes

Flight altitudes differed during baseline years as in 2009 all Little Gulls were registered below 30 m, but in 2010 birds were recorded in all altitude bands (Figure 1.25).

FEHMARNBELT BIRDS



Figure 1.25 Daytime visual observations at Puttgarden onshore station (top) and Rødbyhavn onshore station (bottom): flight altitudes of Little Gull in spring (left) and autumn (right) 2009 and 2010.

1.3.5 Summary

Swans, geese, ducks, waders and gulls have been recorded in high numbers during the two baseline years by visual observations, real-time tracking and tracking radar. Results point out, that with regard to flight directions and paths most of these species show some degree of independency from topographic features and flight altitudes are generally higher than for type 1 species. Baseline observations, in particular from spring 2009 confirm recent studies (e.g. Green 2004), that in particular *Branta* geese and wader species will wait for favourable winds to start their migration.

In general these species do not rely particularly on the Fehmarnbelt for migrating over water or crossing, nor do they seem to be affected by any topography or artificial structures during their migration. Only some species like gulls can be attracted by artificial structures. A potential risk of collision can apply for all type 2 species, when – due to strong winds or inclement weather – their migration routes exactly cross the Fehmarnbelt and flying altitude would be within the altitude of bridge structures.

1.4 Landbirds migrating during daytime (type 3 species)

For landbirds migration over sea is risky as landing and shelter is not an option and the ability to compensate for wind drift is limited. Soaring species like birds of prey and e.g. Common Crane (*Grus grus*) choose their migration routes at the shortest distance over water as uplifting thermals are mainly available over land. Thus, these species will use updrafts over land areas, and cross the Fehmarnbelt gliding when departing land and in active flight over water and/or at low altitudes (see Appendix B.7, Meyer et al., 2000, Baisner et al., 2010). Other species mainly performing active flight such as passerines, swifts and pigeons will choose a migration route dependent on wind and topographic features to optimise flight time and energy expenditures (e.g. Alerstam and Petterson

FEHMARNBELT BIRDS

1977, Bruderer and Liechti 1998, Erni et al., 2005, Liechti 2006, Jenni-Eiermann et al., 2010). Thus, migration is steered by topographical features. These species will follow coastlines in order to either “find and choose” those crossing points or to end up at cumulation points, from which they have to cross. These crossing points can be seen in Figure 1.26 as dashed red lines. Typical representatives for this migration strategy in the Fehmarnbelt are birds of prey, cranes, storks, crows, Jackdaws (*Corvus monedula*) and pigeons as well as the day-migrating passerine species such as Skylark (*Alauda arvensis*), wagtails, Meadow and Tree Pipit (*Anthus pratensis*, *Anthus trivialis*), finches and Siskin (*Serinus serinus*); yet, some of these passerine species will also perform night-time migration.

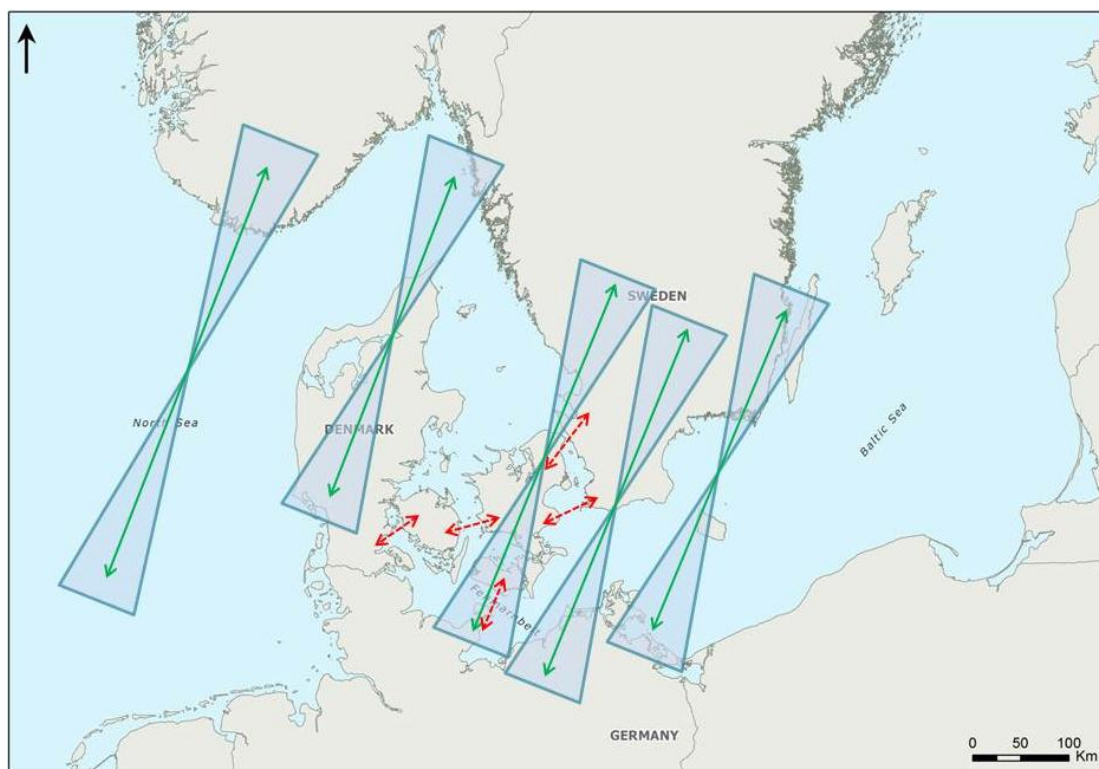

Figure 1.26 Schematic migration routes of landbirds in the western Baltic Sea. Red dashed lines / arrows: migration routes across Belts and Sunds representing landbird daytime migration using shortest distances over water. Green solid lines and shaded areas: migration routes showing variability in location and direction and representing broad-front migration predominantly during night-time.

It has been proposed, that these landbird species are likely to cross the Fehmarnbelt in the closest vicinity of the planned fixed link and in most cases more or less parallel to the link with Puttgarden at the Fehmarn side and Rødbyhavn at the Lolland side as culmination points of migrating landbirds. High recorded numbers of type 3 species during the two baseline years as well as several studies support this assumption (Skov et al., 1998, Koop 2004, Kahlert et al., 2005, Koop 2010). However, it has to be acknowledged that other locations at the Fehmarn NW coast or the Lolland SW coast may serve as crossing points, e.g. Hyllekrog, some 11 km SE of Rødbyhavn (DOF – unpubl. <http://www.dofbasen.dk>, Kahlert et al., 2007). In addition, observations of coasting versus crossing flight behaviour, albeit limited to the points of observation, have provided hints, that at least for smaller species departure

FEHMARNBELT BIRDS

points may well be located at the NW tip of Fehmarn during spring and at Hyllekrog or near Albuen during autumn (chapter 4.3.3).

The larger species of these type 3 species were well registered both by visual observations and by the tracking radar at Rødbyhavn in 2009 and at Puttgarden in 2010. However, numbers of daytime migrating passerines were most likely underestimated as it was only possible to spot these smaller species in the direct vicinity of the observer at low altitudes.

1.4.1 *Birds of prey*

Birds of prey constitute an important group of birds in several aspects. 15 species have been registered, excluding those with less than 10 sightings overall. Many of those species like Honey Buzzard (*Pernis apivorus*), Black and Red Kite (*Milvus milvus*, *Milvus migrans*), White-tailed Eagle (*Haliaeetus albicilla*), Marsh Harrier (*Circus aeruginosus*), Hen Harrier (*Circus cyaneus*), Montagu's Harrier (*Circus pygargus*), Osprey (*Pandion halietus*), Merlin (*Falco columbarius*) and Peregrine Falcon (*Falco peregrinus*) are listed in the EU Bird's Directive Annex 1, and all species of birds of prey are specially protected under the German Federal Environmental Law (*Bundesnaturschutzgesetz*). Birds of prey are known to use the "Fugleflugtslinien" or "Vogelfluglinie" in high, sometimes spectacular numbers, and e.g. German ornithologists gather frequently during late August to observe the migration of large numbers of Honey Buzzards crossing the Fehmarnbelt.

Phenology and intensity

With 21,704 individuals registered during visual observations in 2009 (4,985 during spring, 16,719 in autumn) and 24,420 in 2010 (4,918 during spring, 19,502 in autumn), birds of prey account both in 2009 and 2010 about for 1.1 % of the total birds counted, but they are considered an important group when it comes to the assessment of potential impacts, due to their high protection status and also due to the fact that for these species which are long-lived and which have a low reproduction rate, additional mortality might lead to population effects.

It is assumed that birds of prey crossing the Baltic Sea within the Fehmarnbelt region originate from breeding populations mainly in Sweden and Finland. Western Russia is excluded since data from this region are scarce, and also the Russian regions north of the Baltic cannot be separated from the other more southerly regions of western Russia from which birds will not at all migrate across the Fehmarnbelt.

Species composition and numbers were in both years quite similar. Conspicuous differences only occurred within the three most common species **Honey Buzzard**, **Common Buzzard** (*Buteo buteo*) and **European Sparrowhawk** (*Accipiter nisus*). Whereas the Honey Buzzard in 2009 with 4,080 registered individuals was the most numerous bird of prey species, in 2010 this species was just the third most common bird of prey with 1,764 individuals. In contrast, the Common Buzzard was observed in much higher numbers in 2010 than in 2009 (2009: 1,954, 2010: 6,236). Most likely this inter-annual variation on number of migrants could be explained by the existence of alternative flyways that these species use under different conditions (see results of satellite telemetry in chapter 5.3).

FEHMARNBELT BIRDS

Numbers registered during the two baseline years are compared to the breeding populations and to other observation programs in Table 1.1.

With regard to Red and Black Kite even low registered numbers represented a remarkable fraction of the estimated breeding population, with up to 50 % of the Red Kite breeding population during autumn 2009 and up to 18.5 % of the Black Kite breeding population during spring 2010. This is owed to the fact that breeding populations of both species are rather low north of the region. Therefore the observed individuals may also include short-distance migrants from regions south of Fehmarnbelt. Furthermore 9.8 % (autumn migration 2009) of the Honey Buzzard breeding population and 5 % (autumn migration 2010) of the Marsh Harrier breeding population were registered.

Table 1.1 Birds of prey species observed during visual observations 2009 and 2010 at land stations and reference numbers. Breeding populations (Mebs and Schmidt 2006); birds passing Gedser 1988 (Desholm 2009), Falsterbo autumn mean counts (Kjellen 2007), maximum numbers autumn Fehmarn coast (Koop 2003-2008). Reference numbers > overall totals of own studies: numbers in red.

Species	Max. numbers visual obs. 2009 & 2010		Proportion of relevant population [%]		Relevant population	Numbers passing Gedser 1988 ^b	Mean autumn numbers Falsterbo 1973-2006 ^c	Maximal accumulated autumn numbers Fehmarn ^d
	spring	autumn	spring	autumn	Breeding populations of Sweden and Finland ^a (2*BP*2)			
Common Buzzard	1.954	6.236	1,2	3,8	164.000	2.452	14.112	5,715
Honey Buzzard	790	4.080	1,9	9,8	41.600	2.702	7.353	8,719
European Sparrow Hawk	645	2.432	0,4	1,4	174.000	5.917	17.286	5,946
Red Kite ^e	112	812	6,8	49,2	1.650	67	631	371
Marsh Harrier	132	372	1,8	5,0	7.500	52	591	280
Eurasian Kestrel	69	174	0,3	0,8	22.000	257	544	138
Osprey	18	98	0,1	0,5	18.578	93	258	159
Merlin	37	58	0,1	0,2	29.800	80	227	121
Hen Harrier	18	48	0,1	0,4	13.400	26	267	69
White-tailed Eagle	26	44	1,1	1,8	2.400	0	13	26
Rough-legged Buzzard	14	40	0,1	0,2	23.000	4.109	918	334
Hobby	70	32	0,4	0,2	18.000	0	50	30
Peregrine Falcon	20	18	2,2	2,0	910	0	29	26
Red-footed Falcon	0	12			0			-
Black Kite	10	6	18,5	11,1	54	0	8	2

^a Mebs and Schmidt 2006, ^b Desholm 2009, ^c Kjellén 2007, ^d Koop 2003-2008, ^e Red Kite breeding population in Sweden much higher today, e.g. 1,950 pairs in 2008 (Kjellen 2009).

Migration of birds of prey was more visible at the departure coasts, as birds may circle and fly along the coast before crossing. Therefore, numbers registered during spring are higher at Puttgarden compared to Rødbyhavn and vice versa. In addition, numbers were generally higher during autumn, as more birds – adults and first-year birds – will migrate. Migration of birds of prey took place during most of both seasons, however, with species-specific patterns.

Honey Buzzards for example show low numbers during spring, but have a rather short intensive autumn migration period (in 2009 between Aug 20 and

FEHMARNBELT BIRDS

Sep 10 and in 2010 between Aug 20 and Sep 6) (chapter 5.3.3, Appendix A.2.12). According to the baseline data and long-term visual observations at Falsterbo, mass autumn migration of Honey Buzzards begins around August 15 with very few birds migrating during the first half of August. Modelling of Honey Buzzard migration show that among the weather parameters considered, wind direction is an important factor that drives migration (chapter 5.3.4).

Common Buzzards appeared at both land stations between mid-March and end of April with most birds registered during March. During autumn migration mainly occurred from the end of September until mid-October, with most Common Buzzards recorded at Rødbyhavn (see Appendix A.2.12). However, migration peaks were recorded at all three stations (in 2009: October 9/10; in 2010: Sept 28-Oct 1 and a second peak Oct 10-13) (chapter 5.3.4). The observations from 2009 and 2010 represent a spotlight on this species' options to migrate in the Fehmarnbelt region depending on local and regional weather conditions as well as population parameters like e.g. breeding success and food availability. Common Buzzards as short-distance migrants show a flexible schedule with regard to migration phenology within their migration period (chapter 5.3.3).

European Sparrowhawks were observed most of spring and most of autumn with low to occasionally high numbers. During autumn 2010 some apparent peaks occurred (end of Aug – beginning of Sep; end of Sep – beginning of Oct)(see Appendix A.2.12).

Red and Black Kites were recorded only occasionally during both spring seasons and during end of September and in October with a few peak migration days during both baseline years (see Appendix A.2.12).

Flight directions

During spring there was no clear pattern in flight directions (Figure 4.20, Figure 4.24, Figure 4.29). At Puttgarden Common Buzzards used SW, W, NW and N directions, whereas at Rødbyhavn N and NE directions were preferred (Figure 1.27, Figure 1.28). Red Kites had at Puttgarden a W/NW and at Rødbyhavn a clear NE orientation (see Appendix A.4.3). These variable flight directions may be caused by short-distance movements of these species. Honey Buzzards and Sparrowhawks migrated at all three stations in N/NE directions (Figure 1.29, Figure 1.30, Figure 1.31, Figure 1.32). For Honey Buzzards departing from Puttgarden in spring, real-time tracking of the horizontal surveillance radar gave a significant flight direction of 35° (NNE) (chapter 4.3.2). It appeared that spring migration directions at Puttgarden were somewhat more variable between NW and NE including birds flying along the coast before crossing, but the majority of the birds did fly directly across the Fehmarnbelt even disregarding wind directions. During autumn, patterns of flight directions for most birds of prey were with a SW/S orientation. This is supported by results of the tracking radar at Rødbyhavn. During spring headings of the three most numerous species tracked (Common and Honey Buzzard, Sparrowhawk) were in 2009 between 23° and 35° (NNE, 166 tracks incl. 190 ind.), whereas at Puttgarden in spring 2010 the pattern was much more variable, such that Honey Buzzard's mean flight direction was 241° (WSW, 71 tracks incl. 117 ind.), Common Buzzard's was 129° (SE, 58 tracks incl. 133 ind.) and Sparrowhawk's was 37° (NNE, 46 tracks incl. 50 ind.). During autumn 2009 the flight directions at Rødbyhavn were for all three species between 196° and 221° (SSW to SW, 265 tracks incl. 947 ind.),

FEHMARNBELT BIRDS

while during autumn 2010 at Puttgarden the range was even smaller between 212° and 220° (SW, 200 tracks incl. 586 ind.) (Appendix B.1 to B.5).

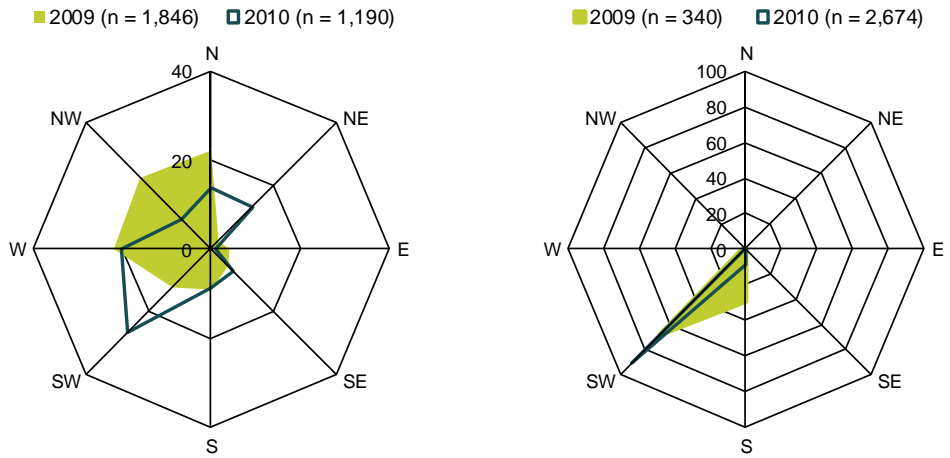

Figure 1.27 Daytime visual observations at Puttgarden onshore station: flight directions of Common Buzzard in spring (left) and autumn (right); results given in %.

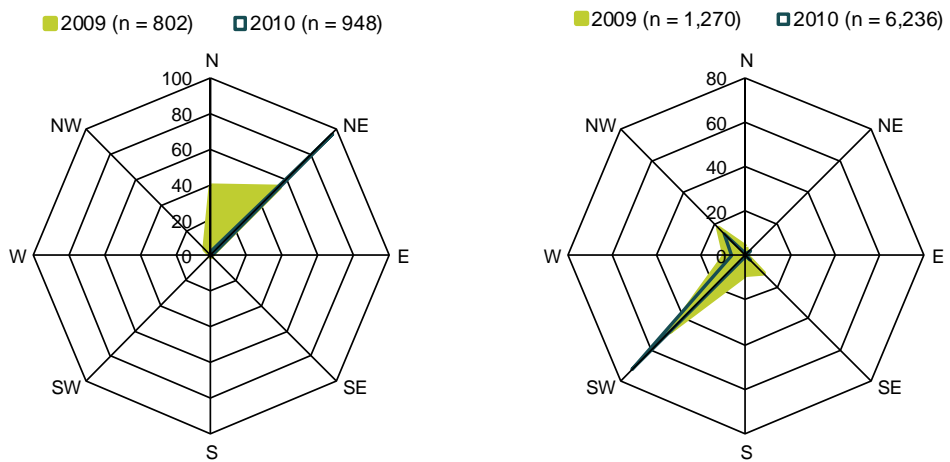
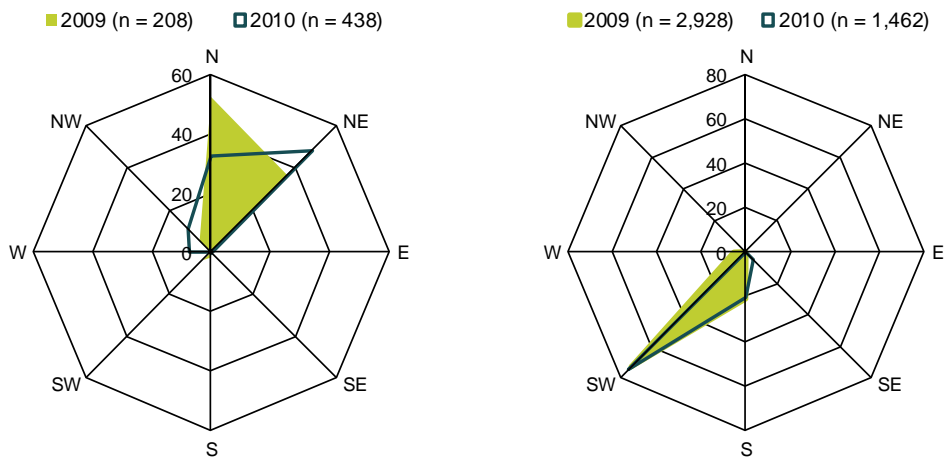

Figure 1.28 Daytime visual observations at Rødbyhavn onshore station: flight directions of Common Buzzard in spring (left) and autumn (right); results given in %.



FEHMARNBELT BIRDS

Figure 1.29 Daytime visual observations at Puttgarden onshore station: flight directions of Honey Buzzard in spring (left) and autumn (right); results given in %.

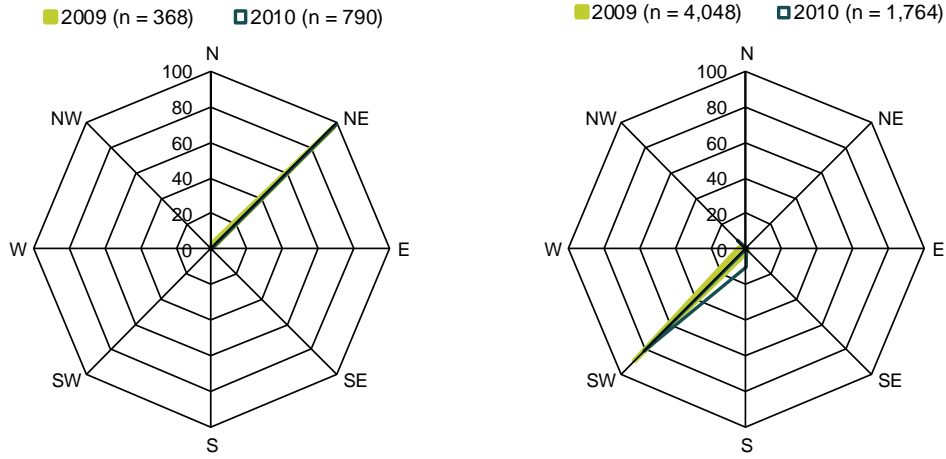

Figure 1.30 Daytime visual observations at Rødbyhavn onshore station: flight directions of Honey Buzzard in spring (left) and autumn (right); results given in %.

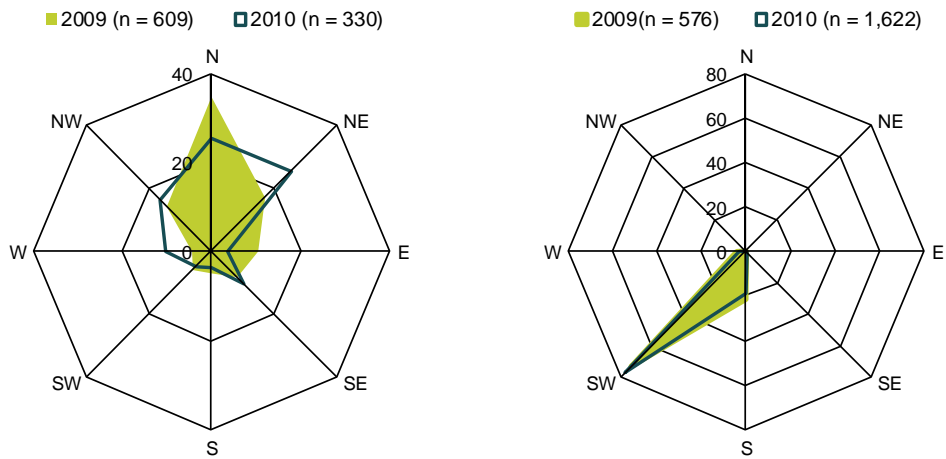
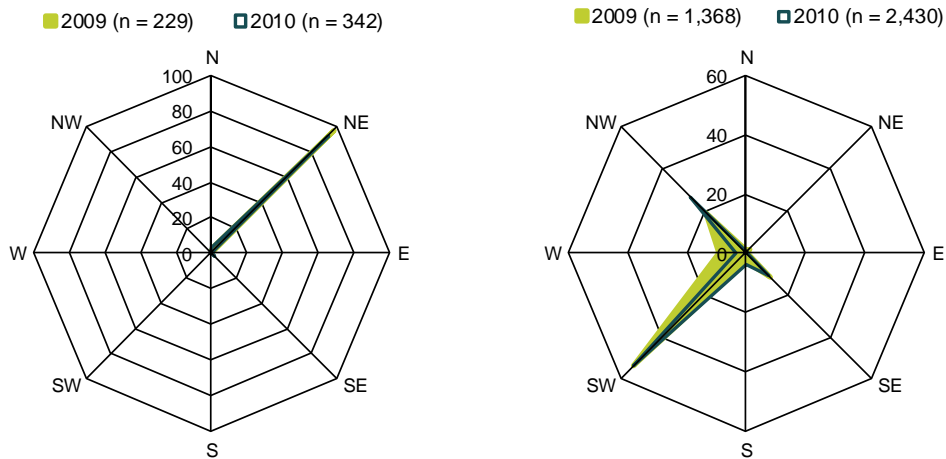

Figure 1.31 Daytime visual observations at Puttgarden onshore station: flight directions of Sparrowhawk in spring (left) and autumn (right); results given in %.



FEHMARNBELT BIRDS

Figure 1.32 Daytime visual observations at Rødbyhavn onshore station: flight directions of Sparrowhawk in spring (left) and autumn (right); results given in %.

Flight altitudes

According to visual observations flight altitudes of birds of prey were more or less regularly distributed between the five altitude categories (Figure 4.68, Figure 4.72, Figure 4.77, Figure 4.75). During autumn 2009 there was a large fraction of low flying birds of prey both at the two offshore stations and at Puttgarden. This pattern was repeated in autumn 2010 but only at the central Fehmarnbelt offshore station. This may be caused by the unfavourable winds and the fact that birds gliding from across Lolland had already reached low altitudes in the middle of the Belt and at Puttgarden. The altitude bands below 30 m were mostly used by **Sparrowhawks** (Figure 1.35). **Honey Buzzards** (Figure 1.34), **Common Buzzards** (Figure 1.33) and **Red Kites** rarely use these bands, but have been regularly registered at the highest altitude band above 200 m.



Figure 1.33 Daytime visual observations at Puttgarden onshore station (top) and Rødbyhavn onshore station (bottom): flight altitudes of Common Buzzard in spring (left) and autumn (right) 2009 and 2010.

FEHMARNBELT BIRDS

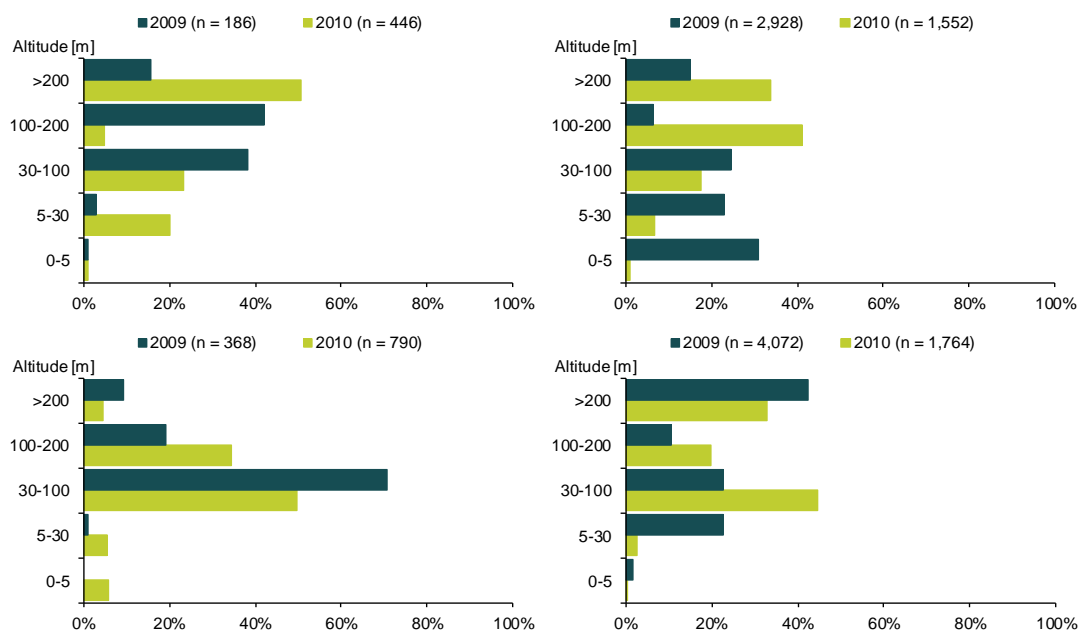

Figure 1.34 Daytime visual observations at Puttgarden onshore station (top) and Rødbyhavn onshore station (bottom): flight altitudes of Honey Buzzard in spring (left) and autumn (right) 2009 and 2010.



Figure 1.35 Daytime visual observations at Puttgarden onshore station (top) and Rødbyhavn onshore station (bottom): flight altitudes of Sparrowhawk in spring (left) and autumn (right) 2009 and 2010.

Flight altitudes of birds of prey as measured by the 'Superfledermaus' at Rødbyhavn during spring 2009 were generally around 190 m. During spring 2010 at Puttgarden the range was between around 370 m for Sparrowhawk and Common Buzzard and around 530 m for Honey Buzzard. This supports the perception that birds circle or "zigzag" to gain height in rising air currents at the

FEHMARNBELT BIRDS

departure coast and come down gliding at the receiving coast (Baisner et al., 2010; see chapter 4.6.1). The tracking of Honey Buzzards by the "Superfledermaus" at Rødbyhavn in spring 2009 showed that birds approached the coastline, quickly descending while gliding down towards land (chapter 4.6.1, Figure 4.108 and Figure 4.109). During autumn 2009 the flight altitudes at Rødbyhavn ranged between 367 m and 482 m, at Puttgarden during autumn 2010 again the flight altitudes differed between the three species with Sparrowhawk flying lowest at around 390 m, Common Buzzard at around 440 m and Honey Buzzard at around 540 m. For the autumn migration the pattern of gaining height at the departure coast and gliding to the receiving coast was not reflected in the data. However, at Puttgarden the lower flight altitudes were not well covered by the 'Superfledermaus' due to the sub-optimal location of the radar observation site. In comparison to Sparrowhawks, Honey Buzzards were in autumn 2009 less often observed zigzagging in relation to the wind direction (chapter 4.6.1, Figure 4.106, Figure 4.108), but used a sinusoidal flight to gain height. Under favourable wind conditions birds may have used thermals or cross-winds to gain height (see chapters 4.3, 4.6.1 and 5.3).

1.4.2 Common Crane

Another day-time migrating large landbird species is the **Common Crane**. This species represents only a small fraction of the observed birds. In 2009, 2,244 and in 2010, 1,474 Common Cranes were recorded by visual observations. Most were registered during spring migration between mid-March and early April (see Appendix A.2.9) with N/NE flight directions (see Appendix A.4.2), while fewer numbers were recorded during autumn seasons, then with S/SW orientations (see Appendix A.4.2). Common Cranes flew in general at high altitudes mainly above 100 m (see Appendix A.5.4). Results of the tracking radar from spring 2010 showed that 16 tracks of 218 individuals had a mean flight altitude of 520 m and a NE mean flight direction for birds leaving the coast of Fehmarn at Puttgarden (see Appendix B.4).

However, for Common Crane, the Fehmarnbelt does not represent the main crossing site over the Baltic Sea. Only 252 individuals were recorded at the Fehmarnbelt during autumn 2009, compared to 5,020 at Falsterbo in the same season. Most of these and the Scandinavian populations are known to cross further to the east at the island of Rügen, Germany (Alerstam 1975, Pennycuick et al., 1979, Prange 2010). It is known, that Common Crane migration phenology is closely related to the weather situations at their stopover sites. During autumn, once temperatures drop below a certain level, Common Crane will proceed with southward migration during day and night-time (Prange 2010, H. Stark, pers. comm.).

1.4.3 Pigeons

A large fraction of all observed migrating birds were **pigeons** (2009: 22.6 %; 2010: 19.8 %), of these most individuals were **Wood Pigeons** (*Columba palumbus*), and the rest belonged to **Stock Dove** (*Columba oenas*) and **Collared Dove** (*Streptopelia decaocto*). In spring seasons, migration was most obvious at Puttgarden in the second half of March. In autumn seasons (October), high intensities of some 5,000 birds per hour were registered at all stations (see Appendix A.2.14). Flight directions during spring were NE/E at Lolland and at the offshore station (Figure 4.23, Figure 4.27), whereas at Puttgarden westerly orientations predominated, suggesting coasting behaviour (Figure 4.19). However, the tracking radar recorded northerly and north-easterly flight directions in spring 2010 also at Puttgarden (Appendix B.4). Real-time tracking

FEHMARNBELT BIRDS

by the horizontal surveillance radar showed with high significance that Wood Pigeon left at Puttgarden in NNE direction (chapter 4.3.2, Table 4.19).

In autumn SW directions were strictly followed by pigeons at all stations according to results from all observation methods (visual observations, real-time tracking of horizontal surveillance radar and "Superfledermaus") (Figure 4.19, Figure 4.23, Figure 4.29, Figure 4.27, Appendix B.3 and B.5, chapter 4.3.2, Table 4.19). They were frequently registered in large flocks and in altitudes above 200 m (chapter 4.4.1). Only during spring at Puttgarden pigeons flew between 30 and 100 m and at the offshore station even below 30 m (Figure 4.67, Figure 4.76). It is supposed, that large numbers of pigeons cross the Fehmarnbelt, and some may have passed unregistered as their flight altitudes can be rather high, as measured for example by the tracking radar "Superfledermaus" with a mean altitude of the tracked flocks of 540 m in autumn 2009 and 820 m during autumn 2010 (Appendix B.3 and B.5).

1.4.4 Passerines – daytime migrants

Passerines represent with 21 % in 2009 and 27 % in 2010 a considerable fraction of all visually observed birds during the two baseline years. During both baseline years the most common passerines were **Fringilla finches** (Chaffinch – *Fringilla coelebs* and Brambling – *Fringilla montifringilla*) with about 9 % of all visual observations in 2009 and 14 % in 2010. The fraction of **Common Starlings** (*Sturnus vulgaris*) is in both years nearly the same with 1.3 % in 2009 and 1.15 % in 2010. Another common species is the **Siskin** with a fraction of 1.3 % in 2009 and 3.3 % in 2010. Registered numbers of mostly daytime migrants are listed in Table 1.2.

Table 1.2 Most common Passerine species observed during visual observations at all observation stations in 2009 and 2010 and fraction of all observed birds.

Species	2009				2010			
	n spring	n autumn	total	%	n spring	n autumn	total	%
Chaffinch sp.	1,104	98,370	99,474	5.20	524	301,472	301,996	14.16
Siskin	742	22,410	23,152	1.28	616	65,416	66,032	3.29
Common Starling	6,336	16,860	23,196	1.30	5,300	18,060	23,360	1.15
Barn Swallow	2,322	7,670	9,992	0.75	4,710	12,580	17,290	0.96
Meadow Pipit	1,888	14,500	16,388	1.24	1,408	8,180	9,588	0.92
Passerine sp.	362	16,818	17,180	1.56	2,494	5,918	8,412	0.88
Chaffinch	17,438	43,588	61,026	3.95	4,002	9,288	13,290	0.74
Yellow Wagtail	1,387	10,376	11,763	0.82	1,366	13,806	15,172	0.72
Tree Pipit	149	15,802	15,951	0.86	238	12,272	12,510	0.60
Eurasian Jackdaw	5,463	5,616	11,079	0.63	5,532	3,176	8,708	0.45
Linnet	2,973	3,256	6,229	0.38	1,762	4,526	6,268	0.38
Skylark	1,699	7,062	8,761	0.54	1,136	4,654	5,790	0.36
Greenfinch	2,591	5,248	5,839	0.43	426	6,708	7,134	0.35
Rook	307	3,510	3,817	0.50	376	4,320	4,696	0.33
Common Redpoll	554	40	594	0.03	56	5,972	6,028	0.28
Blue Tit	1,296	8	1,304	0.07	104	4,330	4,434	0.21
House Martin	288	1,864	2,152	0.17	1,990	1,556	3,546	0.18
White Wagtail	981	1,520	2,501	0.20	638	2,286	2,924	0.16
Reed Bunting	197	3,826	4,023	0.22	356	2,684	3,040	0.14
Goldfinch	215	404	619	0.04	86	2,286	2,372	0.11
Fieldfare	28	764	792	0.04	14	2,140	2,154	0.10

FEHMARNBELT BIRDS

Phenology and intensity

During spring migration, most passerines were seen at Puttgarden land station between mid-March until beginning of April, but migration continued until the end of May. During autumn, the migration intensity at Rødbyhavn was more than ten times higher than at Puttgarden and occurred between end of August till mid-November with peak migration between mid-September until mid-October (chapter 4.2).

Autumn migration peaks of **Fringilla finches** occurred during September in 2009 with a maximum of 2,063 finches per hour on Sep 29 and between end of September until mid-October in 2010 with two remarkable peaks on Sep 22 (7,901 finches per hour) and Oct 5 (5,835 finches per hour) (see Appendix A.2.16).

The largest fraction of **Siskin** was seen during autumn migration at Rødbyhavn and migration peaks between Oct 5 and Oct 11 in 2010 with two maxima of 815 and 2,221 migrating Siskins per hour, respectively (see Appendix A.2.16).

Spring migration of **Common Starlings** was most prominent at Puttgarden between mid-March until mid-April, whereas during autumn migration in October most birds were recorded at Rødbyhavn. Migration intensities of Common Starlings were not that as high as the one of *Fringilla* finches and Siskins, but yielding highest values of only 98 Common Starlings per hour during spring and about 200 per hour during autumn (see Appendix A.2.16).

For **swallows**, the migration pattern in spring was most prominent at Puttgarden during May and autumn migration at Rødbyhavn (September until mid-October) and peak migration intensities re about 170-250 birds per hour (see Appendix A.2.16).

Migrating **Tree Pipits** were recorded both during day- and night-time, but the larger fraction was recorded during daytime, in spring in the end of May and in autumn in the period between from late August to the first days of September. Migration peaks of Tree Pipits were registered during the second decade of May mainly at Puttgarden harbour station in spring and during autumn at all observation stations in the period between August 20 and October 10. Tree Pipit being a long distance migrant has to comply with a tight migration schedule. On the basis of 2009 observations modelling shows that weather parameters provide little explanatory value, while the model including data from two years (2009 and 2010) does explain a relatively large proportion of the variation. Thus, Tree Pipits as a long-distance migrant will have a strong endogenous migration schedule. They will make use of favourable weather conditions, if these are within their migration schedule, but they may also migrate even when weather conditions are less favourable (chapter 5.3.5).

Flight directions

Flight directions of passerines registered by visual observations were at Puttgarden bimodal NW-SE during both spring seasons and SW during autumn (Figure 4.19). In contrast, at Rødbyhavn spring migration was strictly NE orientated, whereas during autumn no such clear migration direction was observed, however, with a tendency to westerly directions (Figure 4.23). Real-time tracking by the horizontal surveillance radar showed in contrast significant

FEHMARNBELT BIRDS

migration directions during autumn at Rødbyhavn, with passerines leaving Lolland with a SSW orientation (chapter 4.3.2).

Flight direction patterns of **Fringilla finches** and **Siskin** were at both land stations quite similar during spring with a bimodal (NW/W to SE) distribution at Puttgarden, which means birds were recorded flying more or less parallel to the coast, and clear NE orientation at Rødbyhavn (Figure 1.36, Figure 1.37; see Appendix A.4.4). This NE orientation was confirmed by results from the 'Superfledermaus' with north-eastern mean flight directions at Rødbyhavn in spring 2009 (n=12 tracks incl. 93 ind.) (see Appendix B.1). During autumn, at Puttgarden most *Fringilla* finches and Siskin flew SW, whereas at Rødbyhavn NW, SW and SE orientation dominated in 2009 and clear SE directions in 2010 with some additional finches flying in W directions (Figure 1.36, Figure 1.37; see Appendix A.4.4).

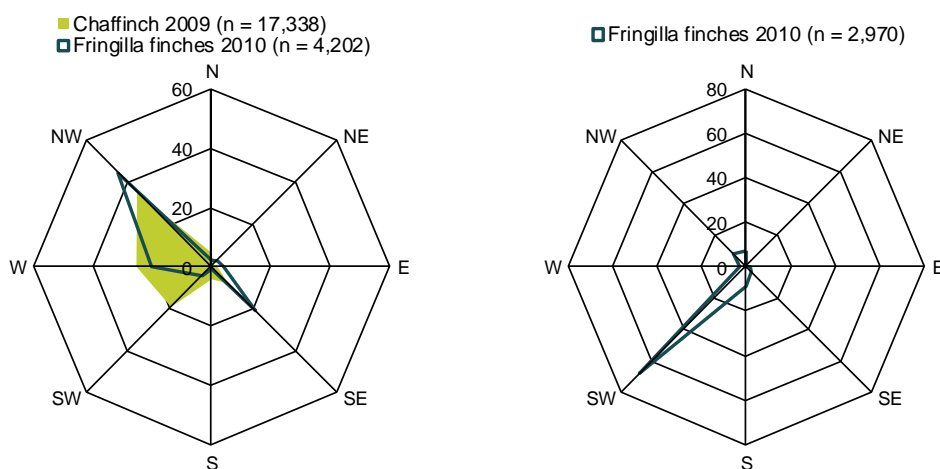

Figure 1.36 Daytime visual observations at Puttgarden onshore station: flight directions of *Fringilla* finches in spring (left) and autumn (right); results given in %. No data for 2009 autumn available.

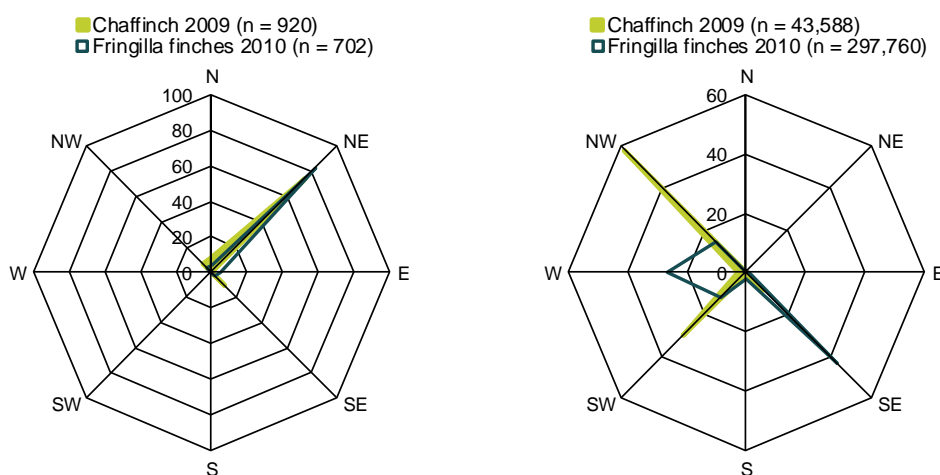

Figure 1.37 Daytime visual observations at Rødbyhavn onshore station: flight directions of *Fringilla* finches in spring (left) and autumn (right); results given in %.

FEHMARNBELT BIRDS

During spring **Common Starlings** flew mainly in SE and E directions at Puttgarden, whereas at Rødbyhavn NE directions dominated. During autumn western directions (SW, W, NW) and mainly NW directions were registered at Puttgarden and at Rødbyhavn, respectively (see Appendix A.4.4).

Swallows showed distinct migration directions. At Puttgarden nearly all Swallows observed followed a NW orientation in spring. During autumn SW directions dominated. At Rødbyhavn NE directions dominated during spring migration and NW and SE during autumn migration (see Appendix A.4.4). This suggests coast-parallel movements at the departure coast, but crossing directions at the arrival coast. Results from the 'Superfledermaus' at Rødbyhavn in spring 2009 showed eastern mean flight directions (n=26 tracks incl. 30 ind.), whereas in autumn 2009 SSE directions (165°, n=71 tracks incl. 151 ind.) dominated (see Appendix B.1 and B.3).

Meadow Pipits showed a distinct NW orientation at Puttgarden and a NE orientation at Rødbyhavn in spring (see Appendix A.4.4). At the offshore station NE to N directions occurred. During autumn migration Meadow Pipits flew in SW directions at Puttgarden, whereas at Rødbyhavn NW to W fly directions dominated. At the offshore station SW and S orientations were recorded. At Puttgarden the results from the 'Superfledermaus' during autumn 2010 migration showed SW orientation for Meadow Pipits as well (n=5 tracks incl. 96 ind.) (see Appendix B.5).

These phenomena of coast parallel migration at the departure coasts and distinct migration directions at the arrival coasts are discussed in detail in chapters 4.3 and 4.6. Flight behaviour at the departure coasts (coasting versus crossing) depends on a number of variables such as angle of the coast lines, wind speed and wind directions in relation to the coast, i.e. onshore or offshore drift (Alerstam and Pettersson 1977, Bruderer and Liechti 1998). Visual observations of migration intensities and migration behaviour (coasting vs. crossing) compared to wind direction and wind speed suggest, that both Puttgarden and Rødbyhavn have characteristics as culmination points for daytime migrating landbirds. Crossing landbirds at Puttgarden in spring are mainly seen during head winds, while at Rødbyhavn in autumn they mainly cross during tail winds. However, during certain weather and wind conditions they may also be just transit points of coasting birds (chapters 4.3.3, 4.6 and 5.1). The radar tracks resolved the local geography of the crossing and coast-parallel migration patterns at Rødbyhavn, while at Puttgarden data did not suffice for analyses. Departing passerines (and pigeons) at Rødbyhavn in autumn prefer the region in the immediate vicinity (east of) the planned alignment as an exit point.

Flight altitudes

During visual observations passerines registered flew in general in altitudes below 30 m at all stations during all migration seasons (Figure 4.67, Figure 4.71, Figure 4.77 and Figure 4.76). It should be noted, that visual observations of migrating passerines at higher altitudes is only possible if these are in large flocks.

Fringilla finches were recorded at Puttgarden mainly in flight altitudes below 30 m, both during spring and autumn migration (Figure 1.38). In contrast, at Rødbyhavn flight altitudes up to 100 m and even above 200 m did occur (see Appendix A.5.5). These results were supported by the 'Superfledermaus' results. During spring the mean flight altitude was 100 m at Rødbyhavn (n=12 tracks

FEHMARNBELT BIRDS

incl. 193 ind.), whereas during autumn it was 423 m (n=3 tracks incl. 140 ind.). At Puttgarden too few *Fringilla* finches were tracked in 2010 for a comparison (Appendix B.1 to B.5). With results by the "Superfledermaus" the arriving behaviour at the Lolland coast can be described. In spring 2009 Chaffinches were observed gliding down towards Lolland while quickly descending (chapter 4.6.1, Figure 4.124, Figure 4.125), with tracks rather straight heading towards the coast in comparison to autumn. When departing at the Lolland coast in autumn 2009 only three flocks of Chaffinches were identified and tracked, but each of them gained height when crossing the Fehmarnbelt. Two out of three tracks indicated that birds were zigzagging close to the coastline when they started to gain height (chapter 4.6.1, Figure 4.126, Figure 4.127).

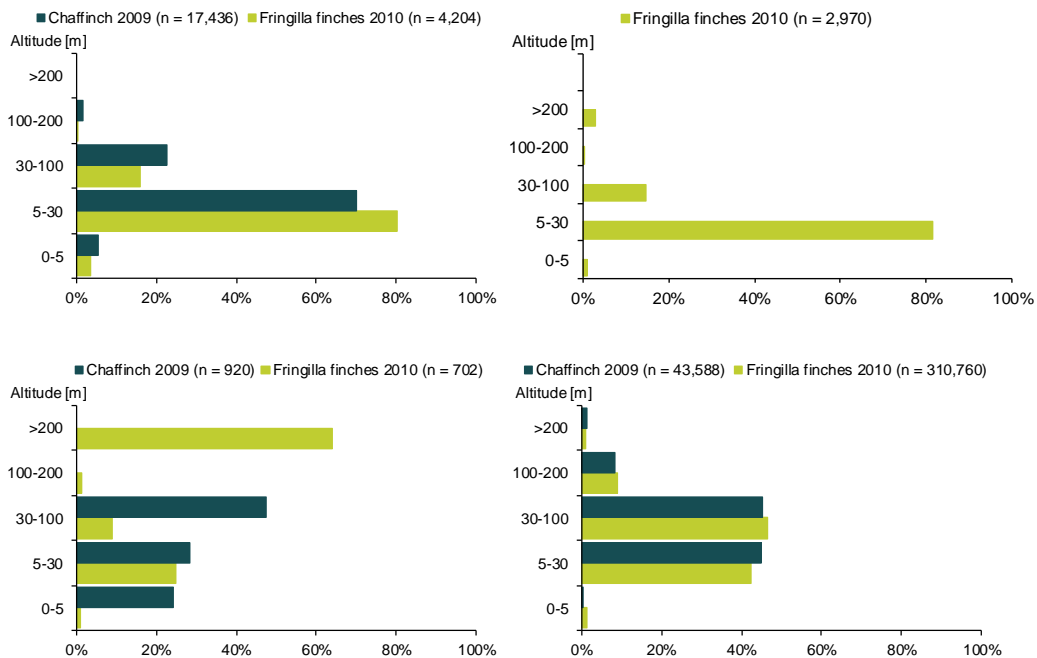

Figure 1.38 Daytime visual observations at Puttgarden onshore station (top) and Rødbyhavn onshore station (bottom): flight altitudes of *Fringilla* finches in spring (left) and autumn (right) 2009 and 2010. No data for Puttgarden 2009 autumn available.

Siskins have been recorded at both land stations and at the offshore station mainly in the altitude band between 5 and 30 m. At the offshore station Siskins were seen even in the lowest altitude band up to 5 m (see Appendix A.5.5).

Common Starlings were recorded at the altitude bands between 5 and 30 and 30 to 100 m (see Appendix A.5.5). **Swallows** and **Meadow Pipits** seemed to fly even lower mainly in the range below 30 m (see Appendix A.5.5). For Swallows and Meadow Pipits the results from the visual observation did not coincide with the results from the 'Superfledermaus', as the 'Superfledermaus' detected Swallows in mean flight altitudes of around 100 m in spring (n=26 tracks incl. 30 ind.) and 330 m in autumn (n=71 tracks incl. 151 ind.) and Meadow Pipits even in altitudes of around 550 m (n=5 tracks incl. 96 ind.) (see Appendix B.1 to B.5). However, it must be noted that it is almost impossible to record small passerines above an altitude of more than 100 m by visual observations.

FEHMARNBELT BIRDS

Overall flight altitudes registered during visual observations for passerines were generally low, with most birds observed within the lower 30 m, most likely due to the limited visual detectability of migrating passerines at higher altitudes. Accordingly, visual observations are often referred to as “visible bird migration” (e.g. Alerstam 1978). In consequence, this means that also during daytime a large proportion of bird migration will occur unregistered by visual observations, and can only be recorded indirectly. Therefore, methods including radar devices applied during the investigations provided valuable information on altitude profiles, flight directions and flight behaviour (Appendix B.1 to B.5). Besides, altitude profiles from daytime migration as measured by the fixed pencil beam or the vertical surveillance radar (chapter 4.4.2) regularly showed medium to high migration intensities at altitude categories above 1,000 m, also for signals identified as “passerine type” by the fixed pencil beam radar.

1.4.5 Summary

The baseline investigations conclude that in particular many of the soaring species are indeed using the Fehmarn link to cross the Baltic Sea. Consequently, Rødbyhavn and Puttgarden at both sides of the Fehmarnbelt function as departure and as arrival culmination points for a high number of daytime migrants. These species can probably assess the shortest distance across the Fehmarnbelt and thus concentrate directly along the alignment of the proposed link.

Species performing active flight (most passerines, crows, pigeons and some birds of prey) are shown to follow the coastline as long as the weather conditions are not suitable for crossing and to cross during favourable weather conditions. The exact relations of weather variables with migration direction are complex. Both Rødbyhavn and Puttgarden serve as culmination and as transit points depending on migration conditions, in particular wind. It is also important to note that both the baseline observations and published data suggest varying migration strategies. Short-distance migrants have a higher flexibility to migrate during favourable weather conditions as their migration timing is not as tight. Long-distance migrants, however, are “bound” to a tight migration schedule and thus may have to also cope with unfavourable weather conditions during their migration (chapters 4.6 and 0).

1.5 Landbirds migrating over a broad-front during night-time (type 4 species)

Night-time migrating landbirds fly large distances during night, frequently at high altitudes and do not depend on short crossing distances as the daytime migrants described in chapter 1.4 (Bruderer and Liechti 1998, Meyer et al., 2000, Erni et al., 2005). Their migration directions and migration intensities at any given location depend to a certain degree on the local weather conditions, in particular wind speed and wind direction. However, their migration phenology also depends on the larger regional weather situation at their departure regions (Alerstam 1990, Liechti 2006, Newton 2008, Hüppop et al. 2009). Their NE/SW migration routes – presented as widely placed green arrows indicating the main migration direction including some variation in flight directions (Figure 1.26) – will cross over the Fehmarnbelt region in a broad front, and only a fraction of them will, depending on the overall migration situation, cross the Fehmarnbelt in close vicinity to the proposed link.

1.5.1 *Passerines – night-time migrants*

Passerines are typical representatives for this migration strategy, but some other species migrate during night-time as well. Not all species can be classified as exclusive nocturnal migrants, but may also show daytime migration due to certain migration conditions (see type 3 species). While species like thrushes (Song Thrush – *Turdus philomelos*, Blackbird – *Turdus merula*, Redwing – *Turdus iliacus*) and Robin (*Erithacus rubecula*) are well-known for their flight calls, other species like the *Sylvia* warblers and reed warblers (*Acrocephalus spec.*) are mostly silent during migration, making species-specific observations impossible.

It has to be acknowledged that with regard to the quantity of numbers of migrating individuals nocturnal migration will most likely include far more birds than diurnal migration altogether, as millions of passerines will migrate at night-time across large regions of Europe. Nocturnal migration is not regular, but occurs in peaks, with migration intensity and timing most likely depending on a combination of factors like local and regional weather conditions, food abundance at the departure regions as well as breeding success. Beyond the existence of pronounced migration seasons, migration phenologies with regard to periods of high and low intensities will also vary from year to year.

For these type 4 species, direct data are most difficult to obtain. Visual observations are not possible, and acoustic data are subject to a number of limitations, such that the calling species might only be registered at short distances and calling activities are dependent on other factors (chapter 0). Thus, in addition to results from acoustic observations (chapter 0), results from the different radar devices are considered to best describe and analyse the migration of these type 4 species (chapters 4.2.2, 4.3.3, 4.4.2, 4.5). Migration intensities from the fixed pencil beam radar and results from the tracking radar were in 2009 obtained at Rødbyhavn (chapter 4.5.1 and Appendix B.1 to B.3) and in 2010 at Puttgarden (chapter 4.5.2, Appendix B.4 and B.5). Results from the vertical surveillance radar were obtained for 2010 (chapters 4.2.2 and 4.4.2) and from the horizontal surveillance radar for the autumn 2009 and all of 2010 (chapter 4.3.3). However, results based on the use of these radar based observations will inevitably be more general than for the type 1, type 2 and type 3 species.

Phenology and intensity

Analyses of the phenologies of type 4 species based on the vertical surveillance radar observations show that a large degree of synchronicity exists between all stations (Table 4.17 in chapter 4.2.2). This suggests that a) nocturnal bird migration registered at the different stations will include a high proportion of the same birds crossing over the Fehmarnbelt, b) broad-front migration may occur at all stations with comparable phenology and intensity. However, the synchronicity of phenologies at the NW corner of Fehmarn with the other stations at the link confirms, that nocturnal migration does not concentrate at the Fehmarn link, but occurs on a broad front, as widely acknowledged (chapter 4.2.2, Alerstam 1990, Berthold 2000, Liechti and Schmaljohann 2007, Newton 2008, Hüppop et al., 2009).

Comparing migration traffic rates (MTRs), measured in birds per km and hour by the pencil beam radar, within the Baltic region shows, that bird migration intensities at the Fehmarnbelt are overall lower than e.g. measured at the island of Rügen (Germany) or at Falsterbo (Sweden). Also, migration intensities at the Lolland coast are contrary to expectations lower in autumn 2009 than in spring

FEHMARNBELT BIRDS

2009, which maybe explained by the high numbers of waterbirds included in the migration rates in spring; at the Fehmarn coast in 2010, autumn migration intensities were comparable to spring.

It must be noted, that migration routes of nocturnal migrants including location, direction and altitude to a large degree depend on overall migration conditions at the departure locations and the actual weather conditions such as wind speed and direction at different altitudes, cloud height, precipitation and visibility. Orientation and migration of type 4 species is steered by a combination of species-specific orientation mechanisms which are not yet completely understood, and further depend on weather conditions. Impacts from artificial light and e.g. vertical structures exist.

Results of acoustic night-time observations show periods of high and low migration intensity (chapters 0 and 0). During spring 2009 the highest numbers of calls were registered at the offshore central Fehmarnbelt station during two consecutive nights (April 5/6) with up to 584 calls/h (Figure 4.11). In 2010, between March 17 and May 20 four migration peaks occurred, on March 17/18 with up to 864 calls/h, April 26-29 with around 300 calls/h each, May 13 with 692 calls/h and May 20 with around 480 calls/h (Figure 4.11). During autumn migration, high intensities of night-time migration of passerines were recorded both at the Puttgarden harbour and at the Rødbyhavn harbour station (Figure 4.4, Figure 4.8). Migration nights with more than 400 calls/h in autumn 2009 were September 30, October 27/28 and November 9-13; in autumn 2010 September 21, 26/27 (maximum of 4,480 calls/h), October 12 and November 1/2. In 2009, autumn migration lasted from mid-August until mid-November, whereas in 2010, September 21 was the first day with migration peaks at all observation stations and at the beginning of November numbers of night-time migrating birds declined. Thus, the autumn migration period was in 2010 shorter and more concentrated than in 2009.

Flight directions

Horizontal radar results showed that a proportion of the nocturnal migration occurred coast-parallel, presumably including migrating waterbirds (chapter 4.3.3). However, high numbers of night-time radar signals were registered crossing the Fehmarnbelt in the expected migration directions, in particular at Rødbyhavn and at the offshore location (e.g. chapter 4.3.3). These observations are supported by results from the tracking radar which unambiguously recorded crossing directions for almost all diurnal and nocturnal signals above 500 m altitude (Figure 4.93 to Figure 4.101 in chapter 4.5).

Flight altitudes

Flight altitudes of nocturnal migrants as measured by the fixed pencil beam showed, that only during autumn 2010 large proportions were recorded above 1,000 m at Fehmarn, while during spring and autumn 2009 at Lolland and in spring 2010 at Fehmarn high migration intensities were also recorded at the lower altitude bands (chapter 4.4.2 and Appendix B.1 to B.5). Flight altitudes as measured by the vertical surveillance radar during 2010 continuously showed that during high migration intensities the altitude distributions were skewed towards higher altitudes, whereas, during low migration intensities, birds flying at lower altitudes represented a larger proportion (chapter 4.4.2). It is further assumed that high migration intensities coincide with good to optimal migration conditions and birds may choose altitudes at which favourable tailwinds occur.

FEHMARNBELT BIRDS

However, these relations are most likely more complex. Comparisons of nocturnal flight altitudes at the different stations during selected migration events supported this general assumption, as altitude profiles may be different at the different stations during inclement or sub-optimal weather, but are more synchronous with the preference of higher altitudes during high migration intensities (all figures chapter 4.4.2).

1.5.2 Summary

The very high numbers of nocturnal migrants at the Fehmarnbelt region have been registered with radar observations and acoustic observations. Results suggest that high migration intensities are comparable between locations. This is confirmed by the results of the acoustic observations (calling intensities) however, with differences at the shore and inland locations. Also, flight directions are mostly SW during autumn and NE in spring. Thus, during night-time, broad-front migration probably occurs in the entire region. As overall migration intensities at the Fehmarnbelt are lower than e.g. at the island of Rügen, Germany or Falsterbo, Sweden, it can be concluded, that a so-called guided broad-front migration linked to the coastlines takes place, with Falsterbo as the southernmost culmination point during autumn as a starting point before crossing the Baltic Sea. Consequently migration intensities are higher east of the Fehmarn link.

2 INTRODUCTION

Fehmarnbelt is a location where long-distance migration of land- and waterbirds occurs and where short-distance movements of waterbirds take place. The long-distance migrations are undertaken by large populations of passerines and pigeons as well as birds of prey moving mainly in a north-easterly direction during spring and in a south-westerly direction during autumn. Therefore, migration directions are more or less parallel to the planned fixed link. However, they may differ depending on the wind and weather situation. Waterbird species like seaducks and arctic geese also undertake long-distance migrations through the Fehmarnbelt, and they generally move in east-west direction crossing the planned link perpendicularly. Short-distance movements are conducted by staging, moulting, wintering or resident waterbirds moving back and forth between areas in the Fehmarnbelt region. They also move more or less perpendicularly to the planned fixed link, as they usually avoid flying over land.

The baseline investigations of the migration of seabirds, waterbirds and terrestrial birds were based on visual observations and radar observations as well as acoustic surveys in the Fehmarnbelt area. Investigations were carried out at two main locations on the coast (Lolland and Fehmarn) and from a ship anchored in the middle of Fehmarnbelt. The investigations were performed during the migratory months and also during the moulting migration, i.e. from February to November in 2009 and 2010 in accordance with the requirements specified in the scoping of the environmental investigations programme for the fixed link across Fehmarnbelt (Femern A/S and LBV 2010).

3 METHODS

Migration is a complex phenomenon, requiring a set of different methods for description and assessment. In order to adequately describe migration patterns across the Fehmarnbelt, a variety of different methods was applied during 2009 and 2010 to cover migration intensity, flight directions and flight height, weather dependencies and seasonal patterns. Wherever possible, visual and acoustic observations were applied or combined with radar observations, as they allow determining migrating birds to species level. However, in order to obtain data on flight altitudes beyond the range of visual observations and in order to study night migration, different radar techniques were used as well.

Visual observations were used to gain data on numbers, flock size and the flight paths of the different species, visual observation proved to be essential. The range of visual observations was, however, limited to less than 1.5 km from an off-shore ship and to less than 5 km from the coast with stronger optical equipment. Observations were thus only delivering data during days with good visibility. Visual observations were carried out for approximately 120 days at the two land stations in Rødbyhavn and Puttgarden and for 60 days from ship. The applied methods followed the specifications described in the "Standards for environmental impact assessments" formulated by the German Federal Maritime and Hydrographic Agency (*Standarduntersuchungskonzept* – StUK 3, BSH 2007).

For surveying bird migration at altitudes above the visible range and during the night, surveillance radars were used. Migratory directions were surveyed with ship surveillance radars with a horizontally turning axis. Altitude distribution and migration intensities were surveyed with similar radars turning vertically.

The radar surveys took place at four locations: Rødbyhavn, Puttgarden, a ship in the Fehmarnbelt and at the Westermarkelsdorf weather station on the coast of Fehmarn, see Figure 3.1. At the land stations the radar devices were constantly in operation, at sea the observations took place in 60 days during the main migration periods.

FEHMARNBELT BIRDS

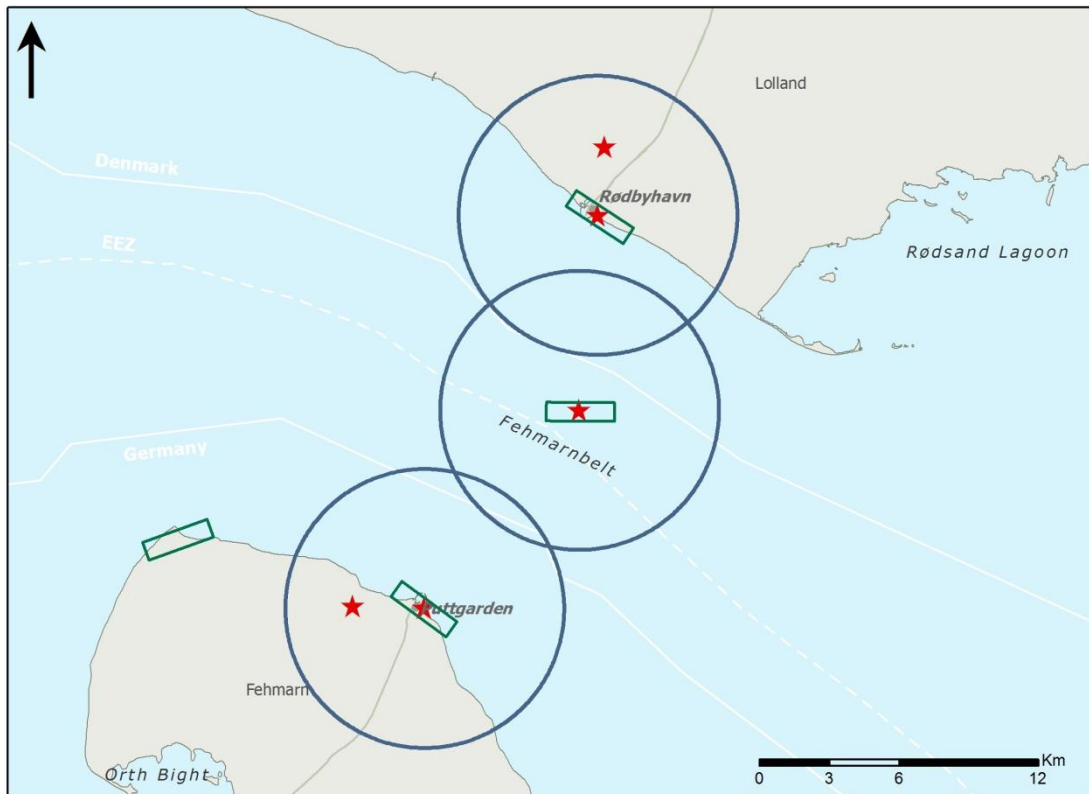

Figure 3.1 Overview of the field stations 2009/2010 with horizontal (blue circle) and vertical radar (green rectangle) ranges. Stations with a red star were manned. Onshore red stars show the inland acoustic stations used in addition to the harbour acoustic stations. At the NW tip of Fehmarn, only a vertical radar was installed.

In Rødbyhavn and Puttgarden a tracking radar with a pencil beam antenna (see below) was also used.

Information on the large-scale patterns of bird migration was also collected through the evaluation of available data from the weather radar station at Stevns in southeast Denmark, meant to supplement the investigations in the Fehmarnbelt. A method for the analysis of bird echoes from the weather radar data had been developed by the Danish National Environmental Research Institute (NERI) and the Danish Meteorological Institute (DMI). The aim had been to describe the migration dynamics on a larger scale and to identify potential migration pathways or flight corridors (Appendix B.7).

In order to attain as complete picture as possible of the regional migratory patterns in the Fehmarnbelt, the data were supplemented by other studies of bird migration along the coast of Fehmarn, Lolland and Falster (Appendix B.6).

The results of the bird migration investigation have been evaluated with regard to species diversity and abundance, migratory direction, migratory routes and altitude distribution with reference to meteorological factors. The results were used to identify, how many individuals from which species or populations pass over the Fehmarnbelt.

3.1 Study site descriptions

3.1.1 Puttgarden (Fehmarn, Germany)

The field station at Puttgarden was located directly east of the Puttgarden ferry terminals inside the Scandlines property. The field station was located south of the harbour exit for the ferry ships. Vantage points were located some 5 m above sea level, enabling observers to cover an offshore half-circle. A double surveillance radar system (horizontal and vertical) was operated during both baseline investigation years. A clutter fence surrounded the radar setup, with a diameter of 10 m and a height of approximately 120 to 180 cm, depending of the slope of the area. In this way, the upper margin of the radar fence was aligned with the T-bar of the horizontal radar in order to shield off potential clutter from the sea surface particularly for sea states >1 (small to high waves).

For people's safety reason the horizontal surveillance radar had a blanking sector between 154° – 245° until May 7, 2009, when it was changed to 154° - 290°. In 2010, no blanking sector was necessary, as the field crew had moved away from the radar. The vertical radar was oriented NW – SE (305° - 125°). Coverage of both radars can be seen in Figure 3.1. A custom-built trailer kept the hardware and working and functioned as a resting space for the staff manning the station (Figure 3.2).



Figure 3.2 Field station Puttgarden with dual radar, clutter fence and trailer.

Next to the radar observation setup, the Swiss radar (tracking and pencil-beam), the so-called 'Superfledermaus' was operated in 2010 by the Swiss Ornithological Institute (SOI).

3.1.2 Westermarkelsdorf (Fehmarn, Germany)

The field station at Westermarkelsdorf was unmanned. A vertical surveillance radar was installed 2.50 m above ground, oriented NE – SW (55° - 235°). A weather-proof container kept the hardware.

3.1.3 Rødbyhavn (Lolland, Denmark)

The field station in Rødbyhavn was located directly east of the ferry harbour within the communal water treatment plant property. The vantage points were some 7 m above sea level. As in Puttgarden, a double surveillance radar system was operated both during 2009 and 2010. Coverage of both surveillance radars can be seen in Figure 3.1. The horizontal radar was mounted on the roof of a pump station, 10 m above ground. The clutter fence with a diameter of 2.70 m was also installed on the roof, the upper rim aligned with the horizontal radar T-bar. The vertical radar was mounted on the NE side of the pump station, oriented NW – SE (305° - 125°) (Figure 3.3). A custom-built trailer kept the hardware and provided workplace for two persons (Figure 3.4).



Figure 3.3 Field station Rødbyhavn with dual radar and clutter fence mounted on the roof, trailer and weather station.

FEHMARNBELT BIRDS



Figure 3.4 Field station Rødbyhavn; inside trailer with radar screen and working computer.

During 2009 the Rødbyhavn field station housed the 'Superfledermaus' installation (tracking, pencil-beam and conical scans). It was located within a 20 x 20 m area about 100 meters inland at an altitude of 3 meter above sea level surrounded by a 2 m ridge (Figure 3.5). This setup was chosen as the dyke provided effective shielding against sea clutter, i.e. could be used as a natural clutter fence (see Appendix B.1 to B.3).



Figure 3.5 Field station Rødbyhavn with Pencil beam radar (Superfledermaus) and Scandlines ferry.

3.1.4 Fehmarnbelt Offshore

In spring 2009 the ship 'Arnar' (Norway, 33.75 m long, 6.7 m wide) was used for the offshore observations. Both horizontal and vertical surveillance radars were installed on the ships' bow at some 5.5 m above sea level (asl). Observers carried out daytime observations from approximately 4.5 m asl.

From July 10, 2009 the 'Arne Tiselius' was used (Denmark, 31 m long, 6 m wide; Figure 3.6). The horizontal radar was installed on the bow some 6.0 m asl and the vertical radar was installed at the stern some 5.0 m asl. Visual observations were conducted from the mid-ship at 3.7 m asl.



Figure 3.6 Arne Tiselius used for offshore observations, here with horizontal radar on front end (in Rødbyhavn).

Stabilisation of the North (N) orientation of the horizontal radar was enabled by connecting it to the gyro compass. The positions of the offshore stations were tested in the beginning of the observation period in 2009. Fixed positions were used after March 30 (Figure 3.7). The offshore Fehmarnbelt position was located at a distance approximately 9 km from the Rødbyhavn field station, and 11 km from the Puttgarden field station.

FEHMARNBELT BIRDS

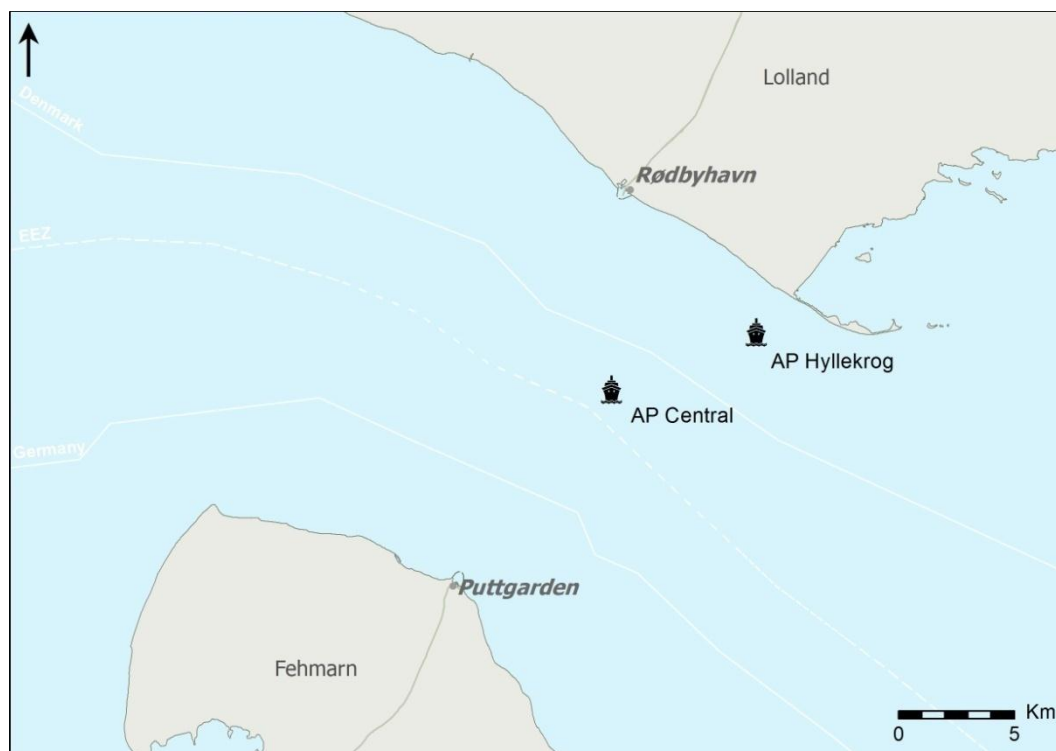

Figure 3.7 Main anchor positions (AP) used for offshore observations. AP Central = offshore Fehmarnbelt, AP Hyllekrog = offshore Hyllekrog position.

3.1.5 Hyllekrog offshore station

Hyllekrog is located 11-12 km east of Rødbyhavn on the southern shore of Lolland. This location is known as a major leaving point of migratory birds in autumn (Skov et al., 1998, Kahlert et al., 2007). Since a land station at this place could not be built up due to logistic problems, observations were carried out from "Arne Tiselius", anchoring approximately 2-3 km SW of Hyllekrog (Figure 3.7) covering migration during autumn 2009.

3.2 Observation Methods

3.2.1 Visual observations

During daylight hours (30 min before sunrise to 30 min after sunset) one observation period of 15 min was conducted every half hour, with these observation periods being at least 5 min apart. At the onshore stations, two transects were observed synchronically, each by one observer: one transect perpendicular to the shoreline towards offshore (sea transect) and one transect parallel to the shoreline eastwards (land transect). The sea transect was watched almost continuously during the observation periods using binoculars and scopes, as described for the method of "seawatching" (Planbeobachtung des Vogelzugs; Dierschke et al., 2005). The land transect was soon changed to a land sector, covering more or less a 360° circle around the observation point; this, because birds over land are generally closer to the observer and must be found in all directions as well as overhead (Gatter 2000). At the offshore stations the visual observations were carried out by two observers covering a 360° circle. Observers used binoculars and telescopes to search for birds. All birds observed were registered, except strictly local birds (harbour, mole/breakwater, shore-

FEHMARNBELT BIRDS

associated etc.), ship-following gulls and local breeding birds. This selection was determined by the individual observers.

Data recorded included species, number, distance, flight direction and height, and behaviour. From all stations, buoys and other markings visible on the radar were used as markers to assist distance estimations. Flight directions were estimated using a compass rose. Flight altitudes were estimated in a few categories;; categories used were "0-5 m", "5-30 m", "30-100 m", "100-200 m", "above 200 m". Behaviour was given in following categories: "flying", "flying, probably resident/local", "flying, probably migrating", "flying, foraging", "flying, with fish", " flying, following ship", "landing on water", "flying up from the water", in order to exclude certain behaviours or assess whether birds migrate.

Visual observation data were entered into a database common to all stations. Results entered into the databases were double-checked for plausibility and errors by the database manager, who provided a summary which was then checked by the station leaders at the end of each month. Recording methods in the field ranged from filling out field protocols, recording onto a digital Dictaphone to typing directly into the database file.

3.2.2 *Night acoustics*

Acoustic observations were adapted during 2009 changing from "direct observations (real-time listening outside by the observers)" to "recordings" (setup with microphone and recorder; Figure 3.8), which were "listened to" afterwards. In this way one acoustic station could be installed on the ship, and two acoustic stations could be installed at each onshore station each night from autumn 2009 on. Of the latter, one location was placed directly at the stations (onshore locations). From autumn 2009 onwards an additional inland location was chosen for a second acoustic setup. At Puttgarden, this was located 3.9 km inland WSW from the station, with the shortest distance to the shore of 2.2 km. At Rødby it was located 3.0 km inland directly north of the station, with the shortest distance to the shore of 2.5 km.



Figure 3.8 Parabolic dish with microphone inside.

Acoustic observations covered the night-time (30 min after sunset to 30 min before sunrise). Recordings were analysed by listening to them. These analyses followed the same routine as visual observations, i.e. one 15 minutes

FEHMARNBELT BIRDS

observation period was covered per half hour (observation periods at least 5 minutes apart). Bird calls were identified to species level, counted and summed for the 15 minutes period. It is important to note, that the call per time period is the parameter to be entered into the database. The number of flying individuals as well as any other parameters like distance to station, flight direction or altitude cannot be covered by this method. Clearly, recording quality depends on weather conditions. During heavy rain, no recordings were made. During medium to strong winds, recording quality decreased and so did the maximum distance of signals to be recorded. However, no correction of raw data was carried out, as no method is known to do so (Farnsworth et al., 2004, Murray 2005, Hill & Hüppop 2008).

At the offshore ship the automatic recordings of night calls encountered problems such as technical noise and position of the microphone on the ship in relation to wind. These technical problems could not be overcome so "direct observations" continued throughout the project period.

3.2.3 Morning census

In order to obtain additional data on species composition of nocturnal migrants, resting areas at Fehmarn and Lolland close to the field stations were visited at sunrise and investigated for staging birds. One observer walked a fixed transect of about 4-5 km (see Figure 3.9 to Figure 3.11) and recorded all species heard and seen, which were then summed up for the individual census. Breeding birds or birds not belonging to the migrating fraction were not recorded as determined by the observer and / or the station leader. Starting time for the censuses was initially 30 minutes before sunrise until March 25 2009, and was then shifted to 3 hours after sunrise while yielding the same results.



Figure 3.9 Morning census transect (yellow line) at the station Rødbyhavn.

FEHMARNBELT BIRDS



Figure 3.10 Morning census transect (red line) at the station Puttgarden, from March 16 to April 10, 2009.



Figure 3.11 Morning census transect (red line) at the station Puttgarden, from April 11 to May 29, 2009.

3.2.4 Surveillance radar

Conventional ship radars were used (see Table 3.1). The horizontally mounted radar was mainly used to track flight directions and distances to the coast of migrating birds, while the vertically mounted radar was used to record flight altitudes and migration intensity. In spring 2009 both radars were operated at a 6 km range. From autumn 2009 onwards all vertical radars were operated at 1.5 km. The horizontal radars switched between 1.5 km and 6.0 km according to a pre-set schedule in order to make use of the best possible detection capabilities at short and medium ranges. Another surveillance radar in vertical mode was placed at the NW tip of Fehmarn within the area of Deutscher Wetterdienst in Westermarkelsdorf.

FEHMARNBELT BIRDS

Table 3.1 Specifications of surveillance radar.

Brand	Furuno
Type	FAR2127
Power output [kW]	25 kW
Frequency	9,410 ± 30 MHz (X-band)
Horizontal aperture angle of radar	1 degree
Vertical aperture angle of radar	10 degree
Rotational speed [min^{-1}]	24
Antenna length [mm]	2,400

The surveillance radars ran continuously 24 hours a day at the onshore stations, also when no observers were at the station. However, the radar on the ship (offshore Fehmarnbelt offshore plus offshore Hyllekrog during autumn 2009) was only active when the ship was on effort.

Trials in spring 2009 to install an automatic radar data post-processing routine failed. Thus, from September 2009, images of radar screens (screenshots) from the horizontal surveillance radars were stored at a temporal resolution of 60 seconds, and these screenshots were used for further analyses of flight paths, directions and altitudes. A detailed description of the processing of the radar images is given below in chapter 3.4.1.

Since spring 2010, so-called "real-time tracking" was applied using the horizontal surveillance radars on the three stations, essentially identifying tracks seen on the horizontal radar in the field and providing species, numbers and altitudes (see chapter 3.4.3 for a detailed description).

3.2.5 **Swiss tracking and pencil beam radar - 'Superfledermaus'**

The ex-military pencil-beam radar of the type 'Superfledermaus' was used for the observations at Rødbyhavn in 2009 (Figure 3.5) and in Puttgarden in 2010. It is a X-band radar (3 cm wavelength) with a peak power output of 150 kW and a pulse repetition frequency of 2,082 Hz (for details see Bruderer 1997a/b, Bruderer 2007, Bruderer and Boldt 2001). To store the radar data, the 'Superfledermaus' was modified and equipped with a digital recording system, developed by the Swiss Ornithological Institute (SOI).

The Superfledermaus radar can be operated in "tracking mode", "fixed pencil beam mode" and "conical scan mode".

- Tracking mode producing three-dimensional tracks: During daytime manual and automatic searches for bird signals were performed, during night-time only automatic searches. Results are flight paths in three dimensions and speed; during daytime visual species / species group identification and flock size, during night-time signal identification based on wingbeat patterns is provided (bird type categories) (e.g. Bruderer et al., 2010). Tracks are qualitative data, because only one bird or a flock can be tracked at the same time. Therefore, the maximum number of tracks is limited by the mean duration of the tracks. In addition, the effort depended on the migratory activity (manual tracking).

FEHMARNBELT BIRDS

- Quantitative measures of migration intensities and flight altitudes by two different methods:
Fixed pencil beam mode: the fixed pencil beam measures a coastal transect with 4 elevations (all altitudes covered) and a sea transect with only 2 elevations (low altitudes covered). At the land station Rødbyhavn in 2009 the coastal transect went SE along the Lolland coast, and the sea transect SW across the Fehmarnbelt. At the land station Puttgarden in 2010 the coastal transect went SE along the Fehmarn coast and the sea transect NE across the Fehmarnbelt. Data were categorised based on wingbeat frequencies into different bird types (wader type, passerine type and others) (Zaugg et al., 2008). Results are quantitative migration traffic rates (MTR = echoes/h*km) (e.g. Schmaljohann et al., 2008).
- Conical scanning mode: the fixed pencil beam measures seven elevations circular around the radar. Since the pencil beam is moving, signals cannot be classified as birds, thus results will be plane signal intensities. Clutter can potentially be included.

For details of the methods and radar specifications see technical reports of the Swiss Ornithological Institute in Appendix B.1 to B.5.

During July 2009 an additional high resolution passive infrared imaging system (Inframetrics IRTV-445L) was installed parallel to the tracking radar in order to further identify species during night-time (Appendix B.3). The system enables to display a thermal image on any standard video monitor. The opening angle is 1.8° in the horizontal and 1.4° in the vertical range. The minimum detectable temperature difference is 0.06 degrees; the magnification is 4-15x. Former measurements have shown that a small passerine (e.g. robin) can be detected up to a distance of 3 km against the clear sky (Liechti et al. 1995).

To obtain information about flight direction, flight altitude and ground speed of the birds, the flight paths of single birds or flocks of birds were recorded. The x-, y- and z-coordinates of the target relative to the position of the radar were recorded every second. At night, the radar was operated automatically. Targets were chosen randomly within three different altitude ranges (0-400 m asl, 400-1,500 m asl, 1,500-3,000 m asl). Tailor-made software assigned the search time to the different altitude ranges with the aim to record equivalent numbers of flight paths from the three altitude ranges. During the night, a target (usually a singly flying migrant) was tracked for 20 sec.

During daytime two persons operated the radar manually. A radar operator searched and chose the targets with the help of the screen and via communication with the observer on the radar tower (Figure 3.11). Once found, the observer on the radar tower identified the tracked birds visually with the aid of a telescope (12 x magnification) mounted parallel to the axis of the radar beam (Figure 3.12). As diurnal migrants often fly in flocks, the observer also determined the flock size, if possible.

Radar data were added and incorporated into the training data set used to separate birds from clutter and to classify bird targets into four groups: "passerine-type", "wader/waterfowl-type", "swift-type" and "unidentified"; while a software runs the target discrimination, each site needs to provide additional data to the training set (Schmaljohann 2008, Zaugg et al. 2008).

FEHMARNBELT BIRDS



Figure 3.12 The radar operator searches birds on the screen and assigns them to the radar for tracking.



Figure 3.13 The observer on the radar tower identifies birds flying in the radar beam with the telescope mounted parallel to the axis of the beam.

3.2.6 Weather data

At each onshore station, an automatic weather station was installed, registering the following weather parameters continuously: wind speed, wind direction, precipitation, temperature, and pressure.



Figure 3.14 Weather station used on land stations, mounted on the roof of field station trailer.

However, for later analyses, weather data have been acquired from the Station "Westermarkelsdorf, Fehmarn" from the Deutsche Wetterdienst (Offenbach, Germany). Data per hour include: wind direction, wind speed, temperature, precipitation, air pressure, visibility, cloud height, and cloud cover.

The team of the Swiss Ornithological Institute measured wind speed and direction with the help of a weather balloon twice a day one hour after sunrise and one hour before sunset up to 4,000 m in different heights. With these altitude-specific wind data they transformed radar measured ground speeds into airspeeds and likewise migration direction of tracks into headings (see Appendix B.1 to B.5).

3.3 Databases

Results of the visual observations, night acoustics as well as the morning censuses have been entered and stored to the custom-built database. The raw data has been run through a series of plausibility tests. The results presented in the present report were obtained by means of queries. All times refer to UTC (Universal Time Coordinated). Except for the migrating bird census, all results (individual sums, calls of birds, intensities, flight directions and altitudes) are represented as "time-corrected", i.e. they are extrapolated to an observation time of 60 minutes per observation-hour each.

All quantitative surveillance and pencil beam radar data and associated calibration data have been stored in linked geo-databases. Weather data recorded continuously at the two land stations have been stored.

3.4 Data analyses

3.4.1 Surveillance radars – screenshot analyses

Starting in autumn 2009 radar images of the horizontal radar (=screenshots) were stored via a framegrabber card onto a PC, during the days when the

FEHMARNBELT BIRDS

observers were present. One screenshot was stored every 60 seconds, summing up to 1,440 screenshots per day. From the spring season 2010 and onwards, radar images of both the horizontal and the vertical surveillance radars were taken 24 hours a day independently of the observers' presence. Thus, screenshots exist over 24 hours a day from February 20, 2010 to November 20, 2010, only interrupted by rare technical failures, from five radars running onshore. The two radars on the Arne Tiselius were only active during dedicated radar trips, thus data for a total of 78 days from March 9, 2010 to November 12, 2010 exist, including half-days for the begin and end of those trips.

The horizontal radar, aimed to show flight directions of birds, had to be projected in North-up mode in order to show true flight directions. For the offshore ship this had not been the case during spring 2010, since the radar has not been connected to the ships compass. However, with the data from the ships satellite compass it has been possible to "align" the radar images during post-processing.

Every fifth screenshot was analysed. With 12 radar images per hour this is considered an appropriate sampling frequency to describe movements of birds.

Using tailor-made software, single screenshots were uploaded as a background layer into a coordinate system. Radar signals considered to represent birds (single individuals or flocks) were marked manually on the screen. For this, signals were assessed by moving pattern, flight speed and knowledge of clutter environment and ship signals. Example radar screenshots representing typical clutter from buildings, buoys, ships and false signals were provided in order to help discrimination from "bird signals". Common training sessions of involved observers were provided to reduce variability between them best possible. However, false decisions cannot be excluded entirely. Screenshots covered partly by rain clutter were marked accordingly and were excluded from the analysis, since only a part of the entire screen area could be analysed. The software calculated the vertical and lateral plus the direct distance of the signal from the radar to be stored in a database. In addition to these parameters the following attributes were stored for every screen shot: date, time, and position of the radar / ship. All data were stored either as text files, which were later transferred to geo-databases, or directly as geo-databases.

Data were assigned to "day" for the period from civil twilight in the morning (45-50 min before sunrise) to civil twilight in the evening (45-50 min after sunset) and to "night" for the remaining time periods.

For the data of the vertical radar screenshots, distance analyses were performed for the radar signals, following Buckland et al. (2001). This is a common approach to account for distance dependent detection probabilities. Assuming that the detection probability can be described as a function of distance, results of this specific function was used to correct count data, e.g. from point and line transects. Distance analysis is recommended for German offshore studies (BSH) and has been applied to radar data in several studies (e.g. Stahl and Nehls 2004, Hüppop et al., 2004). It is described as follows: time periods with mass migration are used to assume an even distribution of birds aloft; radar data from the low altitude bands (< 200 m) are loaded into Distance (Vs. 5.0) (Thomas et al., 2006) to find the most appropriate distance function. This will consist of a model (key function = probability density function – defining the shape type) and an extension function (series expansion – defining the shape dimensions). It is recommended to apply the "half-normal" model (BSH 2007). The extensions are all of the type "cosine series". For the distance-correction of the data, each

FEHMARNBELT BIRDS

signal must be multiplied with a factor > 1 according to the individual model and dependent on its distance from the radar device.

Key function "Half-normal" with cosine adjustment terms:

$$g(y) = e^{\left(\frac{-x^2}{2*a_1^2}\right)} * \left(1 + \sum_{j=2}^z b_j * \left(\cos \frac{j * \pi * x}{w}\right)\right)$$

with

- g(y) : distance dependent detection probability
- a₁: parameter of the key function;
- w: range considered (1,500 m)
- j: starting number of adjustment term
- z: ending number of adjustment term
- b: parameter of the extension function
- x: distance of signal to radar

The parameters of the model are defined separately for each of the four surveillance radars and are listed in Table 3.2.

Table 3.2 Parameters as estimated for the detections functions for each radar device using Distance (Thomas et al., 2006).

Term	Puttgarden	Rødbyhavn	Arne Tiselius offshore	Westermarkelsdorf
Key function a ₁	541.7	932.3	896.0	1005.0
Series expansion b ₁	-0.1726	-0.1393	-0.2362	-0.4644
Series expansion b ₂	-0.0000	-0.0397	-0.0000	-0.1454

Results from the vertical radar are migration intensities presented as the mean number of signals per screenshot over selected time periods, as well as relative altitude distributions presented for selected data.

3.4.2 Horizontal surveillance radar – spatial analyses of intensities and flight directions

The number of echoes and tracks as recorded from screenshots of the radar is biased both by the detection rate of the radar and noise sources. The detection rate can be approximated by comparing the number of tracks recorded by the horizontal surveillance radars at the land stations with the number of tracks recorded at the offshore station (Figure 3.15). While the density of tracks recorded at the coast will to some degree depend on the location of flight paths parallel to the coastline and thus the distance to the radar (waterbirds), the distribution of migrating birds offshore is assumed to be equally dispersed and the detection of bird echoes offshore should be uniform. This is however, not the case and as shown in Figure 3.15 detections increase to a distance of 2 km and

FEHMARNBELT BIRDS

decrease after a distance of 3 km. The empirical curve of the offshore station thus describes the distance-dependent detection of the radar.

The left side of the detection curve offshore displayed in Figure 3.15 reflects the elimination of clutter close to the radar by the STC filter (set to 1800 m) and the small volume covered, while the right side of the curve reflects a combination of the distance-related decrease in sensitivity and the increasing volume covered by the radar beam (Figure 3.16). While the shape of the detection curve of the offshore station is concluded to mainly reflect the detection rate of the radar, the very different curves of the land stations indicate an uneven distribution of birds on the coastal zone, however, the detection rate of the radar has to be considered when interpreting such results.

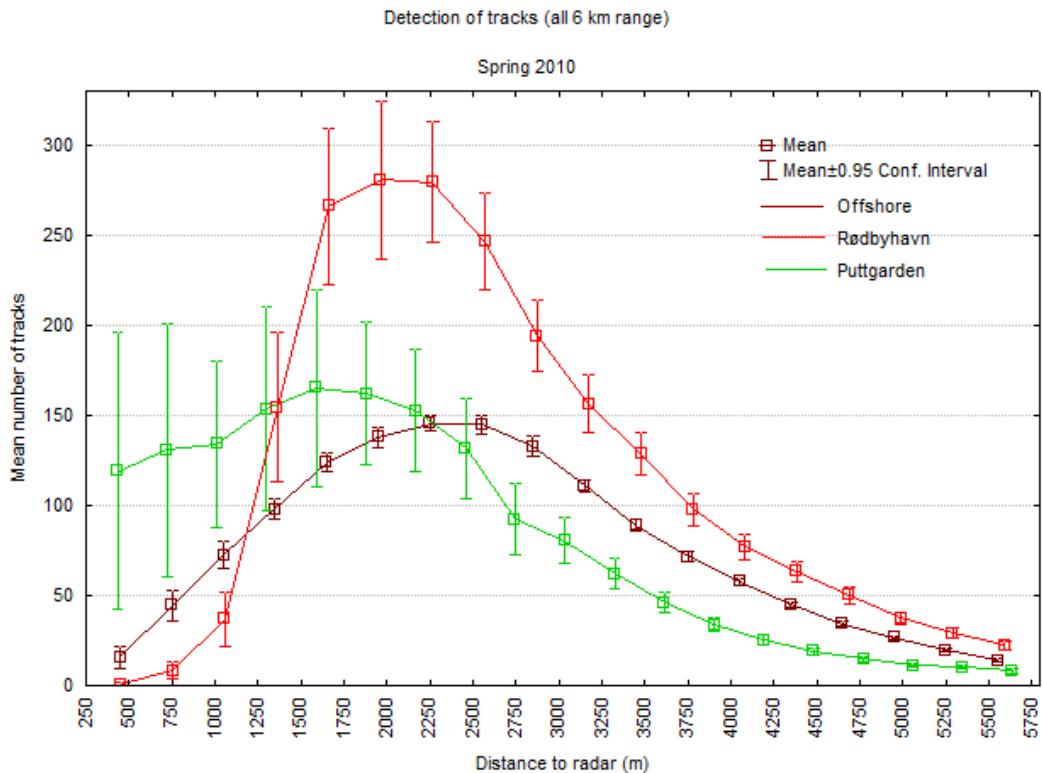

Figure 3.15 Detection of all tracks with a range of 6 km in Puttgarden and in Rødbyhavn spring 2010 compared to the track detection offshore (entire 2010). The plot shows mean (+/- 95% confidence intervals) number of tracks per distance category from radar. Sample sizes: Puttgarden: 41,602. Rødbyhavn: 47,140 and offshore 6,827.

FEHMARNBELT BIRDS

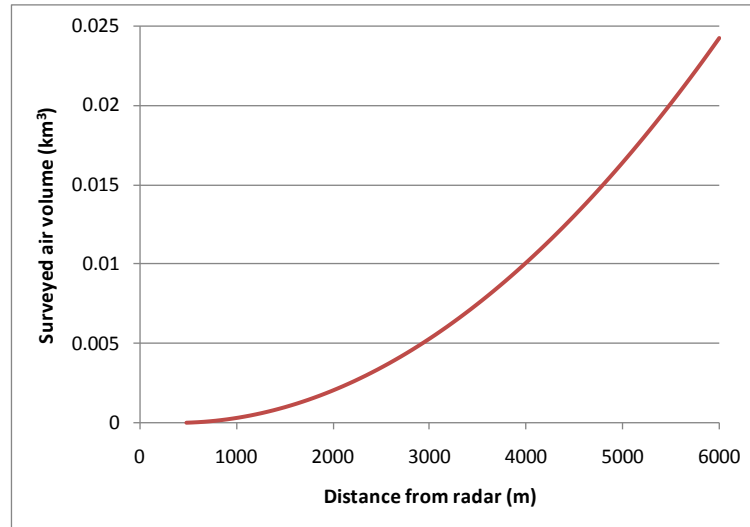

Figure 3.16 Estimated surveyed air volume by the horizontal surveillance radar depending on distance to the radar applying an opening angle of 10°. The estimate assumes equal species-specific radar cross sections.

The shape of the right-hand side of the curve, which mainly reflects decreasing sensitivity with increasing distance, appears to be comparable between the offshore and the onshore stations (Figure 3.15, Figure 3.18, Figure 3.19 and Figure 3.20). However, the detection of echoes will also vary in response to both the size and aspect of the bird echoes (Schmaljohann et al. 2008).

Different types of clutter can bias the detection of bird echoes. Dynamic clutter introduced by rain significantly reduces the detection of bird echoes, and makes tracking of bird movements almost impossible. Therefore, in order to achieve a regular sampling approach, periods with rain identified by at least 5% of the image being contaminated were excluded from analysis. Static clutter from large constructions like buildings creates shading effects. These are most clearly seen in the maps showing total numbers of detected tracks in Puttgarden and Rødbyhavn (Figure 3.17 and Figure 3.21).

No attempts were made to estimate and apply correction factors to take account of the differential detectability with distance. This was deemed unattainable due to the apparent uneven distribution of bird tracks along the two coasts. The combined effects of the STC filter, distance-related variation in sensitivity and static clutter meant that the selection of unbiased track intensities had to be based on a spatial assessment of the actual location of the zone of unbiased detection at each station. The detection maps (Figure 3.17, Figure 3.21, Figure 3.22) allowed for the identification of the site-specific zone of un-biased track detection, where the effects from the STC filter and static clutter was minimal and where the distance from the radar was sufficiently short to allow for detection of most tracks.

The clutter-free zones were defined as the gradient between the plateau of high detectability and areas of lower detectability. These unbiased track intensities from these zones were then used for the analyses of changes in the density of tracks in relation to the distance from the coastline and the planned bridge alignment (see chapter 1.6). Two types of tracks were selected on the basis of flight direction: waterbird-like "coasting" tracks (moving SE (112.5° -157.5°) in spring and NW (292.5°-337.5°) in autumn) and landbird-like "crossing" tracks

FEHMARNBELT BIRDS

(moving NE (22.5°-67.5°) in spring and SW (202.5°-247.5°) in autumn) (as in Table 3.3 in chapter 3.4.5).

For each of the stations track directions were averaged for each month and day/night periods using circular statistics. The calculation of the linear directional mean (LDM) is given as:

$$\text{LDM} = \arctan \frac{\sum_{i=1}^n \sin \theta_i}{\sum_{i=1}^n \cos \theta_i}$$

where θ_i are the directions of a set of tracks from a single origin. It should be noted that while many tracks have several vertices between the starting point and the ending point the average angles were calculated using only the start point and the end point of each track. The average directions were superimposed on a 1 km grid, and visualised as vectors; the length of the tracks being proportional to the mean length of all input vectors, and the location of the tracks being identified as the centroid of each vector.

In addition, the circular variance was estimated to provide an indication of how much directions deviate from directional mean. Given the level of variability in track directions at any location in the radar range the circular variance provides an indication of the number of tracks on which the mean was calculated. The calculation of circular variance (CV) is given as:

$$\text{CV} = 1 - \frac{\sqrt{(\sum_{i=1}^n \sin \theta_i)^2 + (\sum_{i=1}^n \cos \theta_i)^2}}{n}$$

Detection Puttgarden

The detection maps for the horizontal radar in Puttgarden showed that the highest densities of migration were recorded east of the radar location, while low densities were recorded in the north-western sector, over land as well as close to the radar (1 km distance, Figure 3.17). The well-marked zone of unbiased detection is interpreted as an effect of shading from the infrastructures in the harbour. This zone was used for selection of tracks for the analysis of track densities. Low track densities in general over land are due to shading effects from buildings SW of the radar. Figure 3.15, Figure 3.18, Figure 3.19 and Figure 3.20 display the detection of all tracks within a range of 6 km and 1,500 m in Puttgarden during spring and autumn 2010. The detection curve for autumn depicts the same pattern as the maps, with the highest detection found in the distance interval of 1,500-3,000 m from the radar (Figure 3.19), whereas the detection curve for spring shows a large number of tracks recorded as close as 500 m from the radar (Figure 3.15). The larger number of tracks closer to the radar during spring most likely represents movements of locally staging waterbirds off Puttgarden.

FEHMARNBELT BIRDS

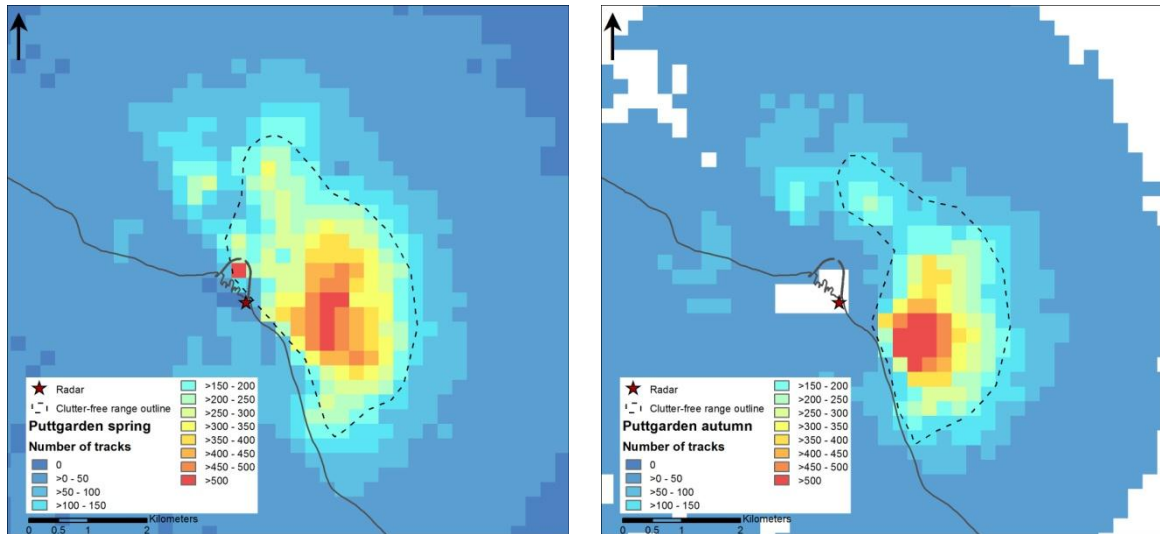

Figure 3.17 The number of recorded tracks with 6 km range at Puttgarden during spring and autumn 2010, and the outline of the clutter-free range used for analyses of the geography of local migration.

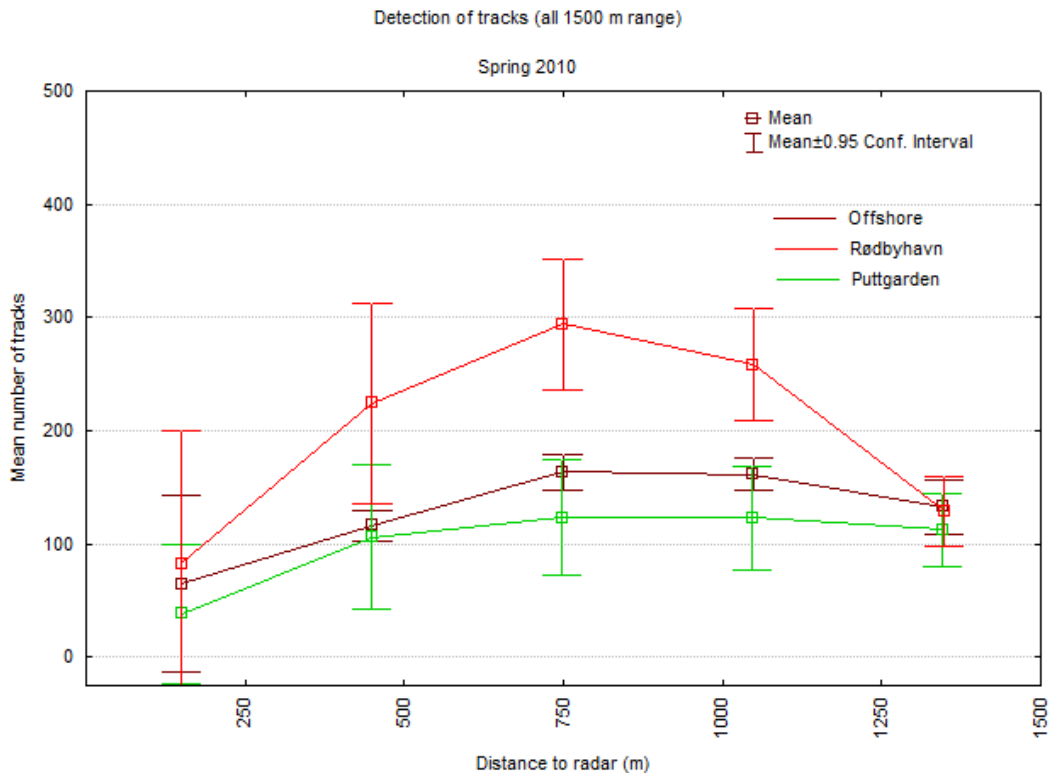

Figure 3.18 Detection of all tracks with a range of 1500 m in Puttgarden and in Rødbyhavn spring 2010 compared to the track detection offshore (entire 2010). The plot shows mean (\pm 95% confidence intervals) number of tracks per distance category from radar. Sample sizes: Puttgarden: 17,118. Rødbyhavn: 12,553 and offshore 2,140.

FEHMARNBELT BIRDS

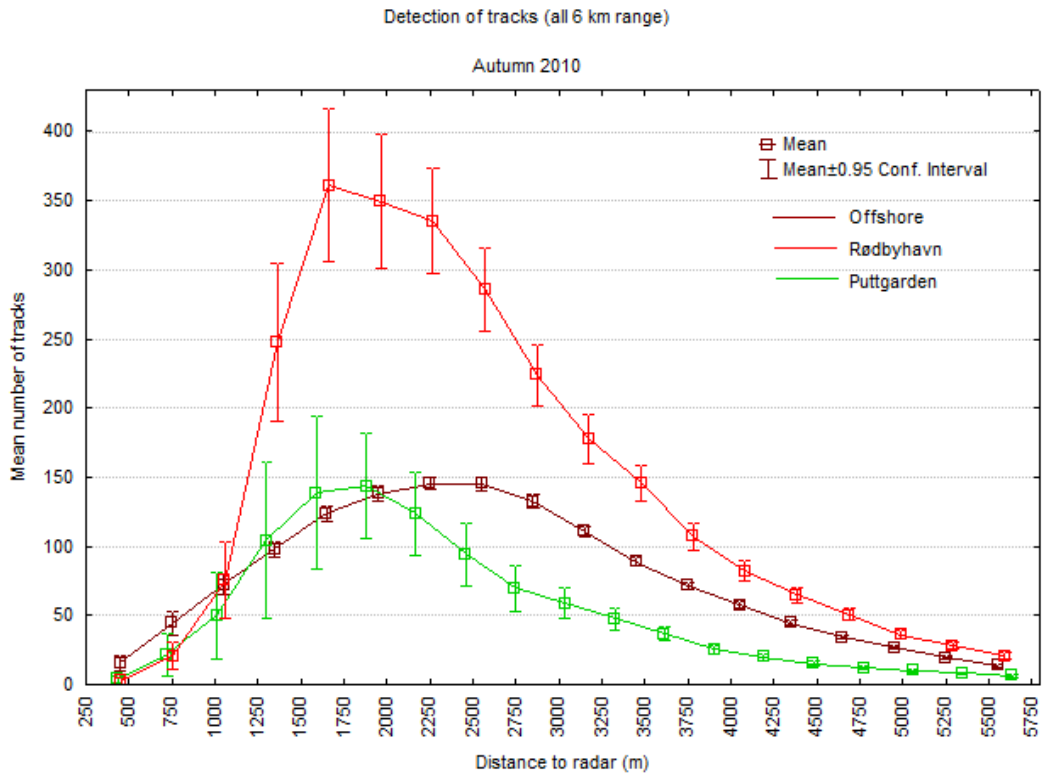

Figure 3.19 Detection of all tracks with a range of 6 km in Puttgarden and in Rødbyhavn autumn 2010 compared to the track detection offshore (entire 2010). The plot shows mean (+/- 95% confidence intervals) number of tracks per distance category from radar. Sample sizes: Puttgarden: 35,298. Rødbyhavn: 57,201 and offshore 6,827.

FEHMARNBELT BIRDS

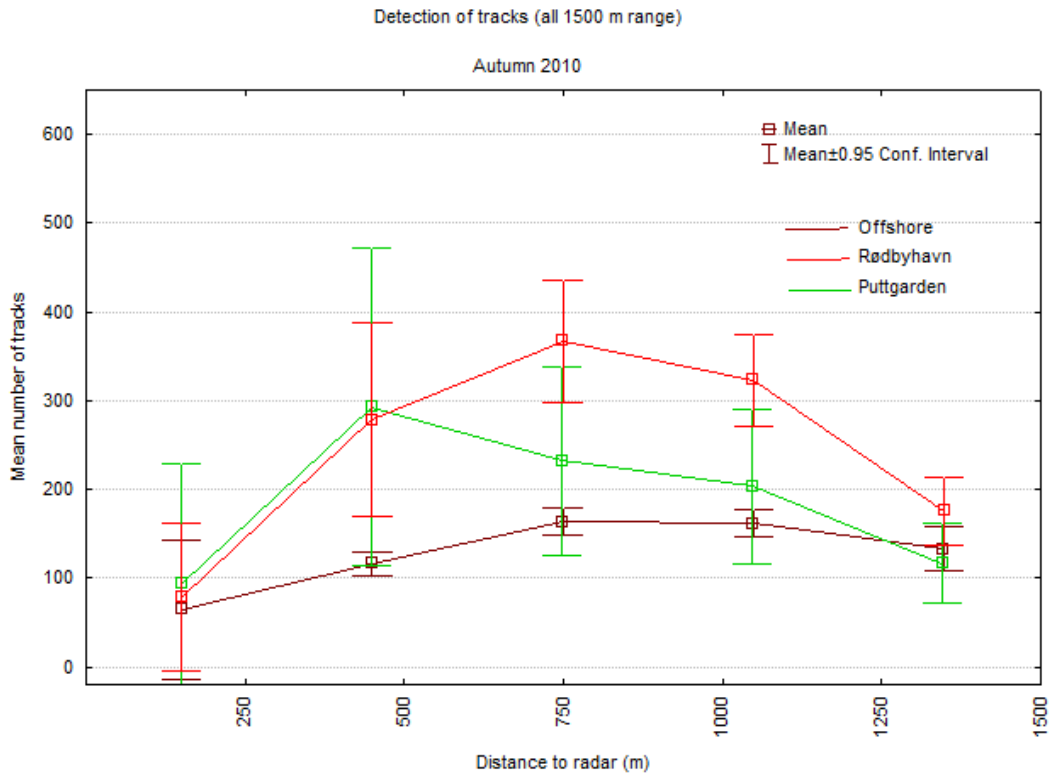

Figure 3.20 Detection of all tracks with a range of 1500 m in Puttgarden and in Rødbyhavn autumn 2010 compared to the track detection offshore (entire 2010). The plot shows mean (\pm 95% confidence intervals) number of tracks per distance category from radar. Sample sizes: Puttgarden: 17,625. Rødbyhavn: 15,758 and offshore 2,140.

Detection Rødbyhavn

At Rødbyhavn the highest densities of tracks were recorded just north and south of the radar station (Figure 3.21). Detection was much reduced west and east of the radar and within 1 km distance. The western sector, seawards of the harbour, had a prominent shading effect from the harbour infrastructures in Rødbyhavn, which largely masked radar signals in this sector. The eastern inland sector was partly shaded due to wind turbines and vegetation. Figure 3.15, Figure 3.18, Figure 3.19, Figure 3.20 display the detection of all tracks within a range of 6 km and 1,500 m in Rødbyhavn during spring and autumn 2010. The detection curves depict the same pattern as the maps, with a well-marked zone of highest detection found in the distance interval of 1,500-3,000 m from the radar. The curves indicate comparable proportions of tracks close to the radar in spring and autumn.

FEHMARNBELT BIRDS

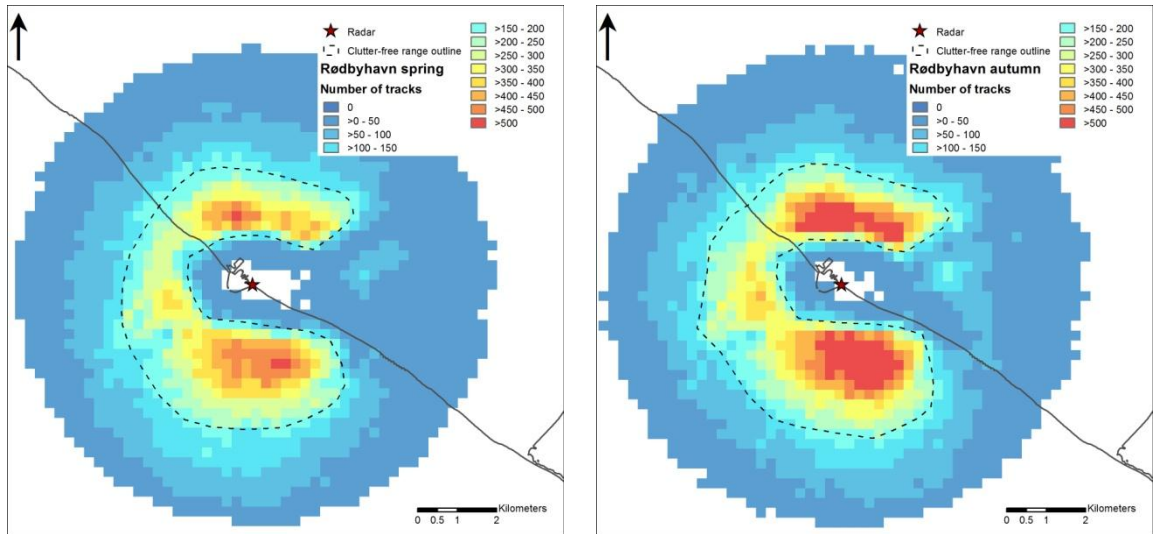

Figure 3.21 The number of tracks recorded at Rødbyhavn during spring and autumn 2010, and the outline of the clutter-free range used for analyses of the profiles of tracks densities.

Detection Offshore

At the offshore position in Fehmarnbelt both the detection maps and curves display a well-marked zone of high detection found in the distance interval of 1,500-3,000 m from the radar (Figure 3.15, Figure 3.18, Figure 3.19, Figure 3.20, Figure 3.22). Due to the blind sector no tracks were recorded in the direction of the stern of the ship. The detection curves indicate comparable proportions of tracks close to the radar in spring and autumn.

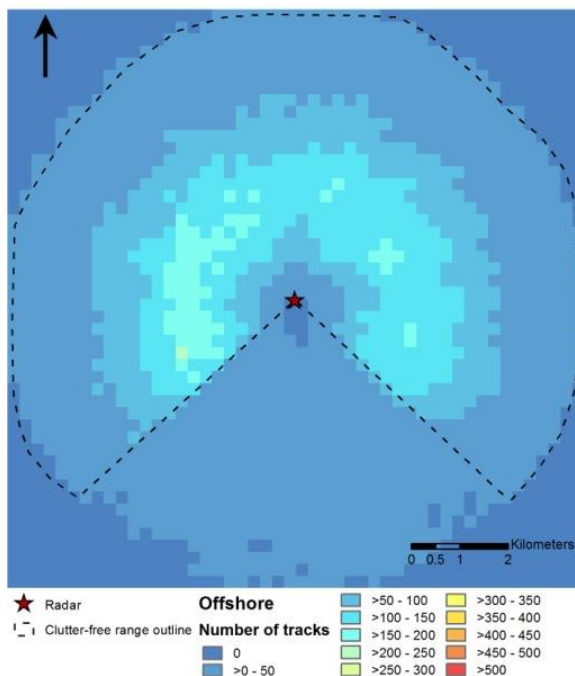

Figure 3.22 The number of tracks recorded at the offshore station during spring and autumn 2010, and the outline of the clutter-free range used for analyses of the geography of local migration. Here, the map is relative to the ship not considering geographical coordinates, to show where the blanking sector is in relation to the ship.

3.4.3 Real-time tracking using horizontal surveillance radar

Using the horizontal radar, but adding species information was accomplished by the so-called "Real-time tracking" procedure. A dedicated software program called "BirdTracker" made it possible to draw / follow tracks of individual birds or flocks on background images, i.e. real-time videos from the horizontal surveillance radar. The videos were produced using a framegrabber connected to the surveillance radar and tailor-made software provided the video as a background image on the PC-screen with the radar position in the centre. Radar ranges 6.0 and 1.5 km were used and respective data stored in separate folders per range.

During tracking the PC screen was divided into two parts, the radar video and the window to record data, including number of birds, flock altitude, flock size (dimension), behaviour, status when start tracking, status when end tracking, comments per track or per session; start and end time, number of nodes and coordinates per node were added automatically.

Two observers were involved in the real-time tracking. One followed the tracks on the screen and recorded the information into a database. The second observer attempted to find the objects in the field, using binoculars or telescope, and provided species names, number of birds and flying altitude. For each observation interval (15 minutes per hour during daytime) a separate session was started. Several tracks plus data could be recorded in parallel (at the same time) on the screen, one of them active. Per track one or more nodes existed, representing the different locations of the track. In addition to the start and the end-point, directions were calculated for all tracks. Figure 3.23 shows one active track in red and two inactive tracks in yellow from the same session. The white line on the right end of the active track indicates where to place the next node. Dots at one end of the track indicate the last active signal.

FEHMARNBELT BIRDS

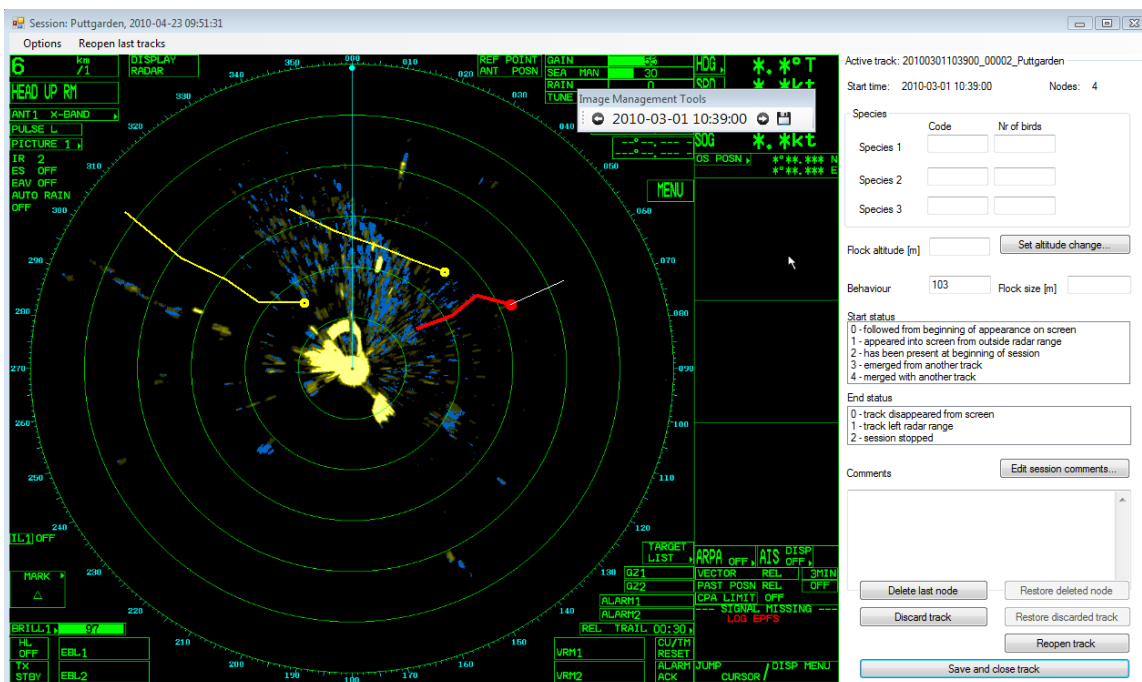

Figure 3.23 Screenshot of "BirdTracker" view with radar screen as background image on the left and editing sheet on the right. Here, one active and two inactive tracks are shown.

The purpose of the tracking session was to track and identify as many birds/flocks as possible. Considering the combination of the sampling frequency and the constraints for the human eye related to identifying all bird movements on a radar screen it is important to stress that the bird tracks identified may well constitute only a proportion of the total number of birds or bird flocks moving through the area investigated. However, as no selective tracking was applied the obtained sample of tracks is considered representative. Also, during very busy situations it has not always been possible to provide identifications for all tracks.

For any further analysis and visualisation, the data stored can be loaded in GIS software like ArcGIS. Selected nodes can be re-drawn and maps of tracking data for selected species and time periods (month, season) can be created.

3.4.4 Swiss tracking and pencil beam radar – 'Superfledermaus'

The tracking data (x-, y- and z-values) of 20 seconds were approximated by regression lines. Averaging these regression lines provided mean values for flight direction and ground speed. The heading of the birds was calculated by subtracting the temporally and spatially closest wind vector (measured by the pilot balloons) from the vector of a bird's track. The heading is the direction the bird intends to fly (the direction of the longitudinal axis of the bird's body).

The distribution of flight directions, headings, ground speed and air speed for three height intervals (0-200 m, 200-500 m, > 500 m) was calculated routinely every day. Although tracks in general represent a good sample of the on-going migration, this method does not allow an estimation of real migration intensity, because the manual searching and choosing of targets may not be random, and the maximum amount of targets which can be tracked per time unit is achieved

FEHMARNBELT BIRDS

already with moderate migration. Therefore, these data provide a qualitative view on the migration recorded.

As a first step in the analysis of fixed-beam data, extensive echoes attributable to clouds or clutter were excluded manually from further analysis. Subsequently, single echoes were automatically detected by tailor-made software. With continuous wavelet transformation a series of variables from the signature of each detected echo was extracted, and then used to distinguish between birds and non-bird echoes, based on a mathematical algorithm (support vector classifier (SVC), for details see Zaugg et al., 2008). The model was previously trained with a randomly selected subset of manually determined echo signatures. In a second step another algorithm (also based on SVC) classified the bird targets into four groups, "passerine-type", "wader/waterfowl-type", "swift-type" and "un-identified".

Once the number of bird echoes per measurement was determined, the number of bird echoes per 50 m height interval ($nH100$) out of the entire measurement series was calculated. As a general measure for the intensity of bird migration the migration traffic rate was used, defined as the number of birds crossing a virtual line of 1 km, perpendicular to the flight direction, within one hour. The migration traffic rate (MTR) was calculated for each hour and height interval of 100 m ($NH100$). To account for the increasing width of the beam with distance, the number of birds flying through the beam within a given height interval was calculated, and corrected for the surveyed area: ($AH100$), divided the product by the area within $AH100$ surveyed by the radar ($aH100$) and extrapolated it to one hour:

$$NH100 = nH100 \times (AH100/aH100) \times 1/T_m$$

$AH100$ = reference area of 1×0.1 km; $aH100$ = area covered by the radar beam within this height interval, T_m – a time factor to relate results to one hour.

Quantification of nocturnal and diurnal migration was performed in the same way. However, as nocturnal migration is dominated by singly flying passerines, these figures are close to real number of birds, while diurnal migration often occurs in flocks, and thus diurnal figures cannot be taken as number of birds, but number of echoes. An estimate of the mean daily flock sizes can be achieved by using the flock sizes of the identified tracks, reported by the observer on the radar.

Mean intensities were calculated for four time periods a day. Day and night was separated by civil twilight and each night and day was again separated into two parts by noon and midnight. For height distribution intervals of 100 m were calculated.

During the observation period 21,300 conical scans were recorded, making up 2,130 measurements (one measurement consist of 10 scans at 10 different elevations). Similar to the fixed beam measurement, clouds, clutter and other non-bird targets (e.g. ships) must be excluded manually. Therefore, for the comparison of the two radar systems four time periods with clear sky were selected to limit the analysis. Clutter was excluded by summing up all images of a given elevation, and excluding cells with high occupancy. It was taken into account that echo identification is not possible, because no echo signature can be recorded during the very short time period when the beam sweeps over the

FEHMARNBELT BIRDS

target, e.g. ships at the edge of the beam can give a similar signal as a bird or a flock of birds.

3.4.5 *Bird migration behaviour and wind*

Methods described here basically cover the analyses used for chapter 5.1 on the influence of wind direction on migration intensity and behaviour of migrants in the Fehmarnbelt as recorded by the visual observations.

The influence of wind direction on migration intensity and behaviour (coasting/departing) of migrating landbirds was analysed using the daily totals of visual observations from Puttgarden and Rødbyhavn. The response variable were the migration intensity and the type of migration behaviour, such as crossing (directions between 22.5° and 67.5° in spring and between 202.5° and 247.5° in autumn) and following the coast (directions between 112.5° and 157.5° in spring and between 292.5° to 337.5° in autumn). These somewhat unusual angles coincide well with the 8 categories given by the observers, which are listed in Table 3.4.

Table 3.3 *Bird migration direction and wind direction categories and corresponding angles.*

Category station	corresponding angle bird migration	Migration directions		Corresponding angle wind direction	Wind directions	
		spring	autumn		spring	autumn
N	337.5 to 22.5			340 to 70	head wind	tail wind
NE	22.5 to 67.5	crossing				
E	67.5 to 112.5			70 to 160	side E	side E
SE	112.5 to 157.5	coasting				
S	157.5 to 202.5			160 to 250	tail wind	head wind
SW	202.5 to 247.5		crossing			
W	247.5 to 292.5			250 to 340	side W	side W
NW	292.5 to 337.5		coasting			

The independent variable was wind direction category. Each day was classified into one of four wind categories with head winds, tail winds, easterly and westerly cross winds. Head, tail and cross winds were defined using the same angular divisions as used for the migration direction. However, as wind data were provided at a resolution of 10°, corresponding angles had to be slightly adjusted.

Non-parametric Kruskal-Wallis ANOVA tests were performed for each response, including multiple (post-hoc) comparisons of average ranks. The tests were performed for each of the 20 most abundant landbird species recorded at either station during the two seasons (see Table 5.1 and following).

The Kruskal-Wallis ANOVA by Ranks test assumes that the variable under consideration is continuous and that it was measured on at least an ordinal (rank order) scale. The test assesses the hypothesis that the different samples in the comparison were drawn from the same distribution or from distributions with the same median. Thus, the interpretation of the Kruskal-Wallis test is basically

FEHMARNBELT BIRDS

identical to that of the parametric one-way ANOVA, except that it is based on ranks rather than means.

For the response variable migration intensities, daily means of visually observed numbers of birds/hour were used.

The analysis of the degree of onshore drift of migrating waterbirds was made using the Kruskal-Wallis ANOVA by ranks test using the daily totals of visual observations from Puttgarden and Rødbyhavn for both spring and autumn seasons.

The response variables with regard to bird behaviour (crossing vs. coasting), were:

- % coasting – percentage of birds of a particular species flying more or less parallel to the coast in westerly direction
- % departing - percentage of birds of particular species departing from the coast

For the independent variable – wind category, the following codes were used:

- "Tail" wind – northerly and north-easterly winds in autumn (340° to 70°), when birds are moving S and SW and southerly and south-westerly winds in spring (160° to 250°), when birds are moving N and NE
- "Head" wind – southerly and south-westerly winds in autumn, when birds are moving S and SW and northerly and north-easterly winds in spring, when birds are moving N and NE.
- "Side E" –easterly side-winds in both seasons (70° to 160°)
- "Side W" – westerly side-winds in both seasons (250° to 340°)

For the % coasting and % departing response variables, the analysis was carried out only for events with number of birds exceeding 10. Only species for which at least 10 days of observations were available were included in the analysis. Kruskal-Wallis tests included only those species with a factor group size of no less than 5.

For testing the influence of wind to migration path distance to coast, the response variable was migration distance to the coast for the observed birds. Sample sizes allowed only for analyses of Common Eider and Common Scoter.

3.4.6 Bird migration intensity and weather

Methods described here basically cover the analyses used for chapter 5.3.

Daytime visual observations at the field stations in Puttgarden and Rødbyhavn provided baseline data for the year 2009 on species, number and estimates of migration direction and migration altitude. Migration intensity [individual/hour] was chosen as the parameter to compare between sites.

In addition to these actual data, additional data sources were used, summarised and commented in an extra technical report (see Appendix B.6):

FEHMARN BELT BIRDS

- migration observations in Schleswig-Holstein, organised by the "Ornithologische Arbeitsgemeinschaft Schleswig-Holstein (OAG)" at selected observation locations in the Fehmarn region. Here data from the last 10 years have been acquired yielding total numbers, and migration intensities, if data suffice;
- visual observations in Denmark, organised by "Dansk Ornitologisk Forening (DOF)" at selected observation locations in the Rødbyhavn region. Here data from the last 10 years have been acquired, yielding total numbers and migration intensities, if data suffice; and
- visual observations at Falsterbo, Sweden, organised by "Skåne Ornitologiska Förening (SkOF)"; here, systematic data of the last 10 years have been provided by Nils Kjellén, Department of Animal Ecology at the University Lund, Sweden. Total numbers and migration intensities have been calculated.

Weather data were provided by the "Deutscher Wetterdienst (DWD)" for the weather station located at the NW tip of the island Fehmarn in Westermarkelsdorf (54°31'41"N, 11°03'38"E). Measurements were taken every hour, some of them automatically, some by human observers. Wind speed was measured as maximum values in 10 min intervals. Parameters were delivered per hour, and were averaged over six hours thus dividing the day in 4 periods in order to get the generalised characteristics of the day.

The maps of large geographic scale wind fields were taken from Earth System Research Laboratory, NOAA -

<http://www.esrl.noaa.gov/psd/data/gridded/data.ncep.reanalysis2.pressure.html>.

In climatology wind direction and speed are presented as the projections of a vector of wind on the x and y axes. X axis goes from west to east, and the projection of wind vector on that axis is called u-component; Y axis goes from south to north, and the projection of wind vector on that axis is called v-component. These two projections could be positive and negative, for example, if $u = 10\text{m/s}$ and $v = -10\text{m/s}$, then the wind blows from 315 degrees and with speed is square root of $10^2 + 10^2$ and equals to 14.14 m/s.

The dynamics of the five most important weather parameters for 2009 are included in modelling together with species specific information. The general description of weather and most important weather parameters can be found in the overview in Appendix A.6. In spring and summer westerly winds were dominating throughout the season, in autumn 2010 wind direction was more randomly distributed.

Due to the complex nature of data, several statistical approaches were applied:

The complete dataset of visual observations for each species and each season was separated into two groups – peak migration days and the rest of the days with weak or no migration. Peaks were identified as days of passage representing 75-90 % of the total number of individuals of each species for each season depending on the sample size. While for spring most species were registered more or less throughout the season, during autumn it was needed to rule out large influences of zero or very low values of migration intensities, which were mostly outside the typical migration period. Here, a "species specific main migration period" was defined for those species which showed a clear phenology. Definition is the median migration date ± 2 Standard Errors (SE) based on 10

FEHMARNBELT BIRDS

years of data from Falsterbo. Weather parameters between these two different situations of peak migration and pauses were compared.

For the analysis of directional data, circular statistics were applied (Batschelet 1981), using the package Oriana 3.0 (Kovach Computing Services); significance of directions was tested with Rayleigh test.

All data for each species and season were taken into the statistical model, using generalised additive model (GAM). However, limitations of the available data are that the number of data points is limited (one point a day per species and season) and the natural variation of migration intensities is very high. While GAM is considered the appropriate approach, these constraints considerably limit the statistical power.

GAMs were used to describe the influence of weather parameters on the daily intensity of bird migration, using the library mgcv from the "R" package (R Development Core Team 2010, version 2.11.1). The Gaussian distribution was used as long as mean daily intensities were the response variables, not count data. mgcv performs automatic smoothing selection, for each model the approximate significance of smoothing terms is given in the Appendix A.9. Thin plate regression splines were used. Due to limited sample size only the most meaningful set of the weather parameters for each species and season was included. However, low sample size also limits the options to validate the model.

For the GAM the following parameters were used:

- Julian day
- Wind direction and speed were represented as Cartesian x and y projections of the wind vector (x_proj and y_proj) and, alternatively, in vector form with a combination of sin and cos of wind direction and wind speed as separate parameters;
- Cloud cover in eighths (0/8 to 8/8);
- Visibility (measured automatically) in m;
- Air temperature in °C;
- Air temperature trend during 3 days – in linear regression coefficient during selected days;
- Precipitation in mm:

In most cases the important parameters explaining large proportions of the variation were Julian day and Cartesian projections x and y of wind vector. Due to the small sample size it was not possible to always include the entire set of weather parameters. So in general only a limited number of biologically meaningful parameters were included. However, the Julian day and wind parameters were kept in every model and the others iterated (see Appendix A.9). The best fitting model was selected using the smallest value of Akaike Information Criterion (AIC).

Visual observations and radar studies were based on different datasets depending on the method-specific detection abilities. Visual observations showed a high detection probability at the departure coast, but a low at the arrival coast. Therefore, in most cases models of migration were selected for Fehmarn in spring and for Lolland in autumn, but models for all combinations are shown in

FEHMARNBELT BIRDS

the Appendix A.9. All the models are descriptive and not tested for predictive power.

3.5 Observation effort and radar coverage

The four radar stations came into operation during February 2009 as planned. However, the start date differed due to cold weather conditions, technical, logistical issues and issues related to obtaining permissions. The starting of operation, active observation days and efforts are listed in Table 3.4. The columns with the number of field days and hours show the days and hours on effort. The station Hyllekrog was covered only in autumn 2009. Starting in autumn 2009, two acoustic setups were put to operation at the land stations, one close to the shore and one somewhat inland, thus overall observation hours of the acoustic investigations increased.

Table 3.4 Field stations 2009 and 2010: operation periods, field days, effort for the different activities.

Field station	Programme and time periods	Number of field days	Observations	Number of hours
Puttgarden - spring 2009	programme partly covered beginning Feb 25; full program: Mar 26 – Jun 10, 2009	56	Visual daytime	845
			Acoustic night-time	394
			Migrating bird census	58
Puttgarden - summer and autumn 2009	Jun 11 – Nov 15, 2009	71	Visual daytime	990
			Acoustic night-time	1,059
			Migrating bird census	38
Puttgarden – winter 2009/2010	Dec 12, 2009 – Feb 19, 2010	11	Visual daytime	54
Puttgarden - spring 2010	Feb 23 – Jun 6, 2010	47	Visual daytime	671
			Acoustic night-time	827
			Migrating bird census	33
Puttgarden - summer and autumn 2010	Jun 8 – Nov 17, 2010	77	Visual daytime	1,048
			Acoustic night-time	1,472
			Migrating bird census	45
Rødbyhavn – spring 2009	Program partly covered beginning February 25; full programme: Mar 7 – Jun 10, 2009	65	Visual daytime	973
			Acoustic night-time	249
			Migrating bird census	93
Rødbyhavn - summer and autumn 2009	Jun 11 – Nov 15, 2009	72	Visual daytime	964
			Acoustic night-time	1,299
			Migrating bird census	66
Rødbyhavn – winter 2009/2010	Dec 12, 2009 – Feb 19, 2010	11	Visual daytime	56
Rødbyhavn – spring 2010	Feb 23 – Jun 5, 2010	51	Visual daytime	766
			Acoustic night-time	965
			Migrating bird census	59
Rødbyhavn - summer and	Jun 15 – Nov 17, 2010	71	Visual daytime	990
			Acoustic night-	1,237

FEHMARNBELT BIRDS

Field station	Programme and time periods	Number of field days	Observations	Number of hours
autumn 2010			time	
			Migrating bird census	74
Fehmarnbelt offshore – spring 2009	Mar 24 – Jun 5, 2009	23	Visual daytime	341
			Acoustic night-time	226
Fehmarnbelt offshore – summer and autumn 2009	Jun 11 – Nov 15, 2009	39	Visual daytime	560
			Acoustic night-time	376
Fehmarnbelt offshore – spring 2010	Mar 10 – May 30, 2010	32	Visual daytime	371
			Acoustic night-time	229
Fehmarnbelt offshore – summer and autumn 2010	Jun 21 – Nov 12, 2010	46	Visual daytime	471
			Acoustic night-time	355
Hyllekrog offshore – summer and autumn 2009	full programme Jun 11 – Nov 15, 2010	24	Visual daytime	309
			Acoustic night-time	270

Table 3.5 Swiss radar 'Superfledermaus' 2009 at Rødbyhavn, 2010 at Puttgarden: field days and effort for the different activities.

Programme and time periods	Number of field days	Observations	Number of hours
Spring 2009 Feb 20 – Jun 10, 2009	97	Tracking radar mode	1,736
		Pencil beam radar mode	590
		Conical scan mode	106
Summer 2009 Jul 3 – Jul 31, 2009	28	Tracking radar mode	502
		Pencil beam radar mode	120
		Conical scan mode	16
Autumn 2009 Aug 13 – Nov 16, 2009	92	Tracking radar mode	1,494
		Pencil beam radar mode	710
		Conical scan mode	100
Spring 2010 Feb 8 – Jun 6, 2010	91	Tracking radar mode	1,337
		Pencil beam radar mode	890
		Conical scan mode	47
Autumn 2010 Aug 15 – Nov 14, 2010	92	Tracking radar mode	1,400
		Pencil beam radar mode	930
		Conical scan mode	46

Radar screenshot analyses

With regard to the vertical surveillance radars, a total of 256,966 screenshots have been included in the further analyses. Only data from 2010 exist (Table 3.6).

Table 3.6 Total number of analysed vertical screenshots (1.5 km range) at each station during each of the three investigated seasons.

	Rødbyhavn	Puttgarden	Westermar- kelsdorf	Offshore	Total
First half-year 2010	31,966	33,696	31,967	8,079	105,708
Second half-year 2010	45,792	47,801	47,807	9,858	151,258
Sum	77,758	81,497	79,774	17,937	256,966

FEHMARNBELT BIRDS

With regard to the horizontal surveillance radars, a total of 182,084 screenshots were included in the analyses, of which 96 % were from 2010. During autumn 2009, the number of screenshots analysed during night-time was only about half of the effort during the daytime (Table 3.7). During 2010, both the daytime and night-time hours were evenly covered. Due to the considerably lower number of field days from the offshore ship, plus the more frequent adverse conditions and heavy clutter on the radar screen offshore, the number of analysed screenshots from the ship was generally lower than from both land stations.

Table 3.7 Total number of analysed horizontal screenshots (1.5 and 6.0 km range) at each station during each of the three investigated seasons.

	Rødbyhavn	Puttgarden	Offshore	Total
Second half-year 2009	5,791	1,067		6,858
First half-year 2010	29,387	50,630	11,606	91,623
Second half-year 2010	35,625	34,956	13,022	83,603
Sum	70,803	86,653	24,628	182,084

Assessment: The observation program for the years 2009 and 2010 was completed according to plans. Visual and acoustic observations at all three manned radar stations ran according to schedule and agreed protocols. Data have been checked for quality, plausibility and correctness and stored in specified databases. Due to a defect A/D-converter the quantitative data from the surveillance radar data for 2009 are not available. However, results of the analyses of the screenshots from autumn 2009 are included and in 2010, further results from screenshot analyses from all stations are added.

3.6 Assessment of methods and coverage

The present report provides results and comparisons of subsets of the baseline data on bird migration obtained in Fehmarnbelt in 2009 and 2010 at four locations, two of them onshore and two offshore.

Bird migration occurs during certain time intervals within one year. However, also within these periods the daily intensity and character of bird migration will vary substantially depending on the local weather, the regional weather and the weather history. For example, periods with headwinds can halt bird migration, thus migration intensities can be very intensive immediately after these periods but may decrease thereafter even if the weather stays favourable. During periods of mass migration the intensity of migration will not be even, but clustered, depending on species and time of the day. While high proportions of some geese or wader populations may pass during very short time periods within the migration season, nocturnal passerine migration can be dispersed over most of the dark hours during migration periods. Diurnal passerine, pigeon and birds of prey migration may be both temporarily and spatially clustered. Different species have different migration schedules; e.g. the seaduck spring migration occurs to a large extent in late March, and Honey Buzzard autumn migration concentrates during a few days in late August; clearly, different species migrate in different periods during the so-called migration seasons following species-specific migration programmes.

The sampling effort of any study approach covering bird migration has to account for these differences and the large degree of scale-dependent (spatial

FEHMARNBELT BIRDS

and temporal) variability. The bird migration monitoring programme was designed to obtain a coverage of at least 50 % of the days during the migration seasons in order to achieve a representative coverage of the migration events. While also concentrating on days with favourable weather conditions, a satisfactory temporal resolution of the spring, moult and autumn migration in the Fehmarnbelt has been achieved. The species composition as well as intensity, phenologies and comparisons with historic long-term migration data show that both the most important and the most numerous species were sufficiently covered by the survey design. The 'Superfledermaus' radar has been running in tracking or fixed pencil beam mode almost continuously in 2009 at Rødbyhavn (not in June 2009) and in 2010 at Puttgarden (not in June/July 2010). Results from the surveillance radars, used in horizontal and in vertical mode, cover most of the autumn 2009 observation period and provide continuous results from late February to mid-November in 2010.

A comparison with historic data from Danish and German bird observation stations (Falsterbo, DOFbasen, OAG SH) (Appendix B.6) further assisted to assess the temporal resolution of the study design.

The selection of three field stations (Puttgarden, Rødbyhavn, Offshore central Fehmarnbelt) in 2009 and 2010 plus the offshore station south of Hyllekrog in autumn 2009 proved to be a well-founded approach, offering a selective, yet sufficient spatial coverage within the Fehmarnbelt region. The distances covered by visual observations depended on the species and the visibility conditions. Large waterbirds have been reliably covered visually up to distances of 3-5 km during good conditions, while migrating passerines have only been covered within a radius of a few 100 m. The coverage of other species like birds of prey, waders and pigeons depended substantially on visibility conditions, too. Flight heights beyond an altitude of 100-200 m, on the other hand, could hardly be covered visually.

While visual observation were invaluable to assess the species composition and individual flight tracks at the observation locations, additional methods were applied to cover times of bad visibility (fog, night) and large ranges.

Acoustic recordings (onshore) and direct acoustic observations (offshore) provided data for the night-time. However, acoustic methods only covered the lower altitudes and species that call during night migration. Further, calling frequencies are not directly related to numbers of migrating individuals. In addition, migrating passerine species may call more frequently when crossing from land to water or when being stressed by illuminated structures such as ships, field stations or others. Nevertheless, acoustic observations provided valuable additional results on species composition, migration intensities and locations of night-time flying birds.

To obtain data on more species not covered by visual and acoustic methods, migrating bird censuses during the mornings (counts of resting migratory birds along a defined transect at both land stations) added some species which migrate at day or night and do not call during migration, or are hard to detect by visual observations. This may still concern species migrating in large numbers, as well as species with low overall numbers.

Different types of radar devices yielded additional results. The tracking radar (Superfledermaus) provided three-dimensional flight paths including species information during daytime and species type information during night-time. Well

FEHMARNBELT BIRDS

suited to describe migration of individual species at a local scale including direction, altitude and also flight behaviour like ascending, descending or circling. Fixed pencil beam radar (Superfledermaus) yielded migration intensities per species type. Results are best suited to describe and quantify more or less regular migration phenomena like nocturnal passerine migration, but less suited to effectively cover clumped migration events or species migrating in large flocks, as is the case for numerous daytime migrating species. Surveillance radars were operated continuously 24 hours a day. In horizontal mode they provided migration directions and spatial distributions and in vertical mode migration intensities (with some limitations) as well as altitude distributions. Results from the vertical surveillance radar gave comparable and relative data for migration intensities and flight altitudes, however, have limitations when it comes to exact quantifications.

The long-range weather radar at Stevns covered a larger region and ranges not reachable by the other radar types operated in Fehmarnbelt, and was meant to complement the data collected locally in Fehmarnbelt with information of regional migration intensities in eastern Denmark. However, it turned out, that the results from the weather radar are difficult to interpret, as detection capabilities, clutter issues, resolution and detection range cannot readily be compared to the other methods used in these investigations. Consequently, it was decided to not further use the weather radar results for comparisons and analyses.

It is concluded that the complementary use of the methods described above complies with and surpasses the methodological standards required for EIA investigations at German offshore sites (Federal Maritime and Hydrographic Agency 2007). Furthermore, these results are complemented by and assessed on the background of historical data (bird observation stations).

4 RESULTS

4.1 Species composition and absolute numbers

The following chapter provides information about species composition and absolute numbers of registered migrating species at the Fehmarnbelt based on three observation methods (daytime visual observations, night-time acoustics and morning censuses) and thus an overview about visual migration. It is divided into subchapters accounting on the different observation locations. The last chapter provides a comparison of own results with those of other observation stations on the flyway.

A total of 224 species plus 36 species groups or unidentified species were registered during the entire year 2009. In 2010 a total of 212 species plus 35 species groups or unidentified species were recorded. The species list of both baseline years contains 230 registered species overall. Overall counted numbers both during visual and acoustic observations were highest in Rødbyhavn, followed by Puttgarden and offshore. Appendix A.1 shows a species list with summed up numbers in separate columns for the separate locations and methods for 2009 and 2010 respectively.

The numbers of species counted by the three different observation methods are presented in Table 4.1, Table 4.2 and Table 4.3.

Table 4.1 Numbers of species by visual observations in 2009 and 2010.

Observation station	2009			2010		
	Spring	Autumn	Total	Spring	Autumn	Total
Puttgarden	152	127	167	133	134	154
Rødbyhavn	116	153	164	86	168	175
Offshore Fehmarnbelt	80	92	117	73	84	95
Offshore Hyllekrog	--	97	--	--	--	--

Table 4.2 Numbers of species by acoustic observations in 2009 and 2010.

Observation station	2009			2010		
	Spring	Autumn	Total	Spring	Autumn	Total
Puttgarden	41	63	71	65	72	83
Rødbyhavn	49	71	79	51	60	72
Offshore Fehmarnbelt	32	22	42	26	22	36
Offshore Hyllekrog	--	23	--	--	--	--

Table 4.3 Numbers of species counted during morning walk in 2009 and 2010.

Observation station	2009			2010		
	Spring	Autumn	Total	Spring	Autumn	Total
Puttgarden	49	50	70	44	41	53
Rødbyhavn	93	99	124	71	91	105

FEHMARNBELT BIRDS

Only a few species could be added by the night acoustics (5 in 2009 and 11 in 2010) at Puttgarden, (12 in 2009 and 7 in 2010) at Rødbyhavn, (10 in 2009 and 9 in 2010) at Fehmarnbelt offshore and (7 in 2009) at Hyllekrog offshore.

More species were added by the morning walks at Puttgarden and Rødbyhavn (Tab. 3.3). Here, particularly the species migrating at night, but not calling, were included, like e.g. the *Sylvia* and *Acrocephalus* warblers.

Species numbers are comparable between the land stations, with more species being recorded at the "departure" coast from which birds leave towards the sea, i.e. the coast of Fehmarn in spring and the coast of Lolland during autumn. The numbers registered during the morning censuses were higher at Rødbyhavn, owing to the more diverse habitats here, which cannot be compared to the morning census habitat on the Puttgarden side. At the offshore locations less species overall were counted. This is most likely an effect of the lower number of days covered offshore, and the adverse recording conditions offshore due to wave movements (systematic use of telescopes not feasible), limited observation range (use of binoculars only) for species detection as well as limited visibility.

4.1.1 Puttgarden onshore station

During both years the daytime visual observations of waterbirds, Common Eider, Common Scoter and Barnacle Goose, represented the highest proportion of birds recorded during daytime visual observations followed by Wood Pigeon, Chaffinch and Common Starling (Table 4.4, see also Appendix A.1).

During the night-time acoustic observations the three thrush species Redwing, Song Thrush and Blackbird dominated in both years (Table 4.4). Other frequently recorded passerines were Tree Pipit and Robin. Among the wader species the Golden Plover was registered in high numbers at the inland acoustic station, especially in 2009. Waterbirds (especially geese) represented another large fraction of birds recorded during night-time observations.

During the morning census, a number of species registered coincide with the upper two lists of most frequent birds. However, some species were added. Wood Pigeons dominated during spring, Common Starlings during autumn. Naturally, the most frequent species were passerines. Gulls were as well often registered.

Table 4.4 Results of daytime visual (transects), night-time acoustic (calls) observations and morning census at Puttgarden onshore station: the 20 most frequent species per method are listed. Species ranked in the top 20 in both baseline years are shaded grey.

Visual observations					
2009			2010		
Species	sum daytime individuals	in %	Species	sum daytime individuals	in %
Common Eider	169,728	31	Common Eider	235,396	39
Wood Pigeon	162,020	30	Wood Pigeon	105,712	18
Common Scoter	45,678	8	Barnacle Goose	48,720	8
Chaffinch	19,592	4	Common Scoter	46,066	8
Barnacle Goose	13,410	2	Meadow Pipit	9,588	2
Black-headed Gull	8,088	1	Great Cormorant	8,500	1
Great Cormorant	7,902	1	Swift	6,862	1
Common Starling	7,808	1	Common Starling	6,470	1
Meadow Pipit	6,066	1	Chaffinch	6,390	1

FEHMARNBELT BIRDS

Eurasian Wigeon	5,793	1	Swallow	6,316	1
Greylag Goose	5,684	1	Eurasian Wigeon	6,114	1
Swallow	5,649	1	Eurasian Jackdaw	5,764	1
Eurasian Jackdaw	5,507	1	Greylag Goose	5,052	1
Rook	3,817	1	Black-headed Gull	4,994	1
Yellow Wagtail	3,423	1	Rook	4,696	1
Red-breasted Merganser	3,386	1	Brent Goose	4,578	1
Linnet	3,377	1	Siskin	4,246	1
Common Gull	3,136	1	Common Buzzard	3,976	1
Honey Buzzard	3,136	1	Little Gull	3,582	1
Greenfinch	2,763	1	Sandwich Tern	2,528	0
	Sum of %	90		Sum of %	87

Acoustic observations					
2009			2010		
Species	night-time calls	in %	Species	night-time calls	in %
Redwing	9,807	19	Song Thrush	54,816	32
Song Thrush	7,938	16	Blackbird	28,726	17
Blackbird	7,141	14	Redwing	20,412	12
Golden Plover	5,460	11	Tree Pipit	8,214	5
Robin	3,048	6	Barnacle Goose	7,786	5
Tree Pipit	3,044	6	Common Scoter	5,102	3
Common Sandpiper	1,408	3	Curlew	4,834	3
Mallard	1,164	2	Robin	4,040	2
Dunnock	1,144	2	Eurasian Wigeon	3,006	2
Barnacle Goose	1,096	2	Greater White-fronted Goose	2,552	1
Eurasian Wigeon	1,000	2	Common Sandpiper	2,538	1
Dunlin	916	2	Golden Plover	2,490	1
Oystercatcher	832	2	Fieldfare	2,312	1
Greylag Goose	674	1	Oystercatcher	2,306	1
Greater White-fronted Goose	638	1	Chaffinch	2,090	1
Ringed Plover	514	1	Greylag Goose	1,970	1
Lapwing	424	1	Yellow Wagtail	1,426	1
Common Scoter	388	1	Dunnock	1,074	1
Moorhen	370	1	Dunlin	1,032	1
Yellow Wagtail	338	1	Meadow Pipit	930	1
	Sum of %	93		Sum of %	92

Morning census					
2009			2010		
Species	morning census individuals	in %	Species	morning census individuals	in %
Wood Pigeon	1,296	22	Common Starling	3,477	44
Common Starling	965	16	Wood Pigeon	708	9
Blackbird	534	9	Common Gull	504	6
Yellow Wagtail	412	7	Herring Gull	339	4
Chaffinch	372	6	Robin	249	3
Great Tit	317	5	Chaffinch	234	3
White Wagtail	298	5	Blackbird	217	3
Blue Tit	278	5	Song Thrush	205	3
Robin	199	3	House Sparrow	196	3

FEHMARNBELT BIRDS

Greenfinch	193	3	Great Tit	161	2
Herring Gull	148	2	Meadow Pipit	136	2
Whitethroat	116	2	Chiffchaff	113	1
Song Thrush	80	1	Linnet	102	1
Tree Sparrow	61	1	Greenfinch	97	1
Lesser Whitethroat	57	1	White Wagtail	96	1
Siskin	45	1	Goldcrest	83	1
Black Redstart	41	1	Blue Tit	82	1
Meadow Pipit	37	1	Whitethroat	75	1
House Sparrow	36	1	Willow Warbler	68	1
Chiffchaff	34	1	Yellow Wagtail	62	1
	Sum of %	92		Sum of %	92

Table 4.5 shows the 10 most frequent species per method in 2009 and allows a comparison of the different observation methods for the different species. Nearly all birds registered in high numbers during visual observations were not covered by night-time acoustic observations (except for Barnacle Geese and Eurasian Wigeon) or by morning census (except for Wood Pigeon and Common Starling). Corresponding to that pattern, species registered in high numbers by night-time acoustics were seldom covered by visual observations or morning census.

Table 4.5 Results of daytime visual (transects), night-time acoustic (calls) observations and morning census at Puttgarden onshore station in 2009. The 10 most frequent species per method are listed. Species belonging to more than one list are shaded grey.

Visual observations	sum daytime individuals	in %	sum night-time calls	in %	sum morning census individuals	in %	species group
Common Eider	169,728	31	0	0	0	0	Seaducks
Wood Pigeon	162,020	30	0	0	1,296	22	Pigeons
Common Scoter	45,678	8	388	1	0	0	Seaducks
Chaffinch	19,592	4	124	0	372	6	Passerines
Barnacle Goose	13,410	2	1,096	2	0	0	Geese
Black-headed Gull	8,088	1	4	0	0	0	Gulls
Great Cormorant	7,902	1	0	0	0	0	Cormorants
Common Starling	7,808	1	46	0	965	16	Passerines
Meadow Pipit	6,066	1	302	1	37	1	Passerines
Eurasian Wigeon	5,793	1	1,000	2	0	0	Ducks
	Sum of %	82					
Acoustic observations							
Redwing	18	0	9,807	19	32	1	Passerines
Song Thrush	20	0	7,938	16	80	1	Passerines
Blackbird	71	0	7,141	14	534	9	Passerines
Golden Plover	246	0	5,460	11	0	0	Waders
Robin	2	0	3,048	6	199	3	Passerines
Tree Pipit	297	0	3,044	6	5	0	Passerines
Common Sandpiper	66	0	1,408	3	0	0	Waders
Mallard	842	0	1,164	2	0	0	Ducks
Dunnock	151	0	1,144	2	20	0	Passerines
Barnacle Goose	13,410	2	1,096	2	0	0	Geese
			Sum of %	81			
Morning census							

FEHMARNBELT BIRDS

Wood Pigeon	162,020	30	0	0	1,296	22	Pigeons
Common Starling	7,808	1	46	0	965	16	Passerines
Blackbird	71	0	7,141	14	534	9	Passerines
Yellow Wagtail	3,423	1	338	1	412	7	Passerines
Chaffinch	19,592	4	124	0	372	6	Passerines
Great Tit	394	0	52	0	317	5	Passerines
White Wagtail	1,783	0	292	1	298	5	Passerines
Blue Tit	1,302	0	0	0	278	5	Passerines
Robin	2	0	3,048	6	199	3	Passerines
Greenfinch	2,763	1	0	0	193	3	Passerines
					Sum of %	81	
Totals	542,201		50,656		6,020		

4.1.2 Rødbyhavn onshore station

Comparable to Puttgarden, the largest proportion of birds observed visually during daytime were Common Eider followed by Wood Pigeon (Table 4.6). In addition a high number of geese were recorded in spring and autumn and a particular fast passage of wader species at the end of May in both years.

During the night-time acoustic observations passerines (including thrushes) dominated again. However, in 2010 waterbirds (Barnacle Goose, Common Scoter, Eurasian Wigeon) constituted a remarkable fraction as well. In autumn 2009 a large number of Tree Pipits were recorded, also during visual observations. The same holds for the Jackdaw. This pattern changed in 2010 with fewer observations of Tree Pipits and no registered calls of Jackdaw.

The number of birds registered during the morning census were high in both years compared to Puttgarden, as already mentioned with regard to the number of species. Besides some obvious resting bird species like Eurasian Wigeon and Mute Swan, most species registered were passerines.

Table 4.6 Results of daytime visual (transects), night-time acoustic (calls) observations and morning census at Rødbyhavn onshore station: the 20 most frequent species per method are listed. Species ranking in the top 20 in both baseline years are shaded grey.

Visual observations					
2009			2010		
Species	sum daytime individuals	in %	Species	sum daytime individuals	in %
Common Eider	345,855	30	Common Eider	321,022	23
Wood Pigeon	250,836	22	Wood Pigeon	312,380	22
Barnacle Goose	69,133	9	Siskin	65,762	5
Chaffinch	44,508	6	Barnacle Goose	58,906	4
Brent Goose	42,495	4	Bar-tailed Godwit	31,524	2
Dunlin	23,672	4	Common Scoter	20,468	1
Siskin	22,412	2	Brent Goose	20,274	1
Common Starling	17,032	2	Common Starling	18,060	1
Tree Pipit	15,820	2	Yellow Wagtail	13,806	1
Meadow Pipit	14,775	1	Swallow	13,540	1
Bar-tailed Godwit	14,410	1	Curlew	13,456	1
Knot	14,038	1	Greylag Goose	12,754	1
Common Scoter	12,918	1	Tree Pipit	12,274	1

FEHMARNBELT BIRDS

Yellow Wagtail	10,392	1	Chaffinch	9,288	1
Swallow	8,077	1	Knot	8,010	1
Skylark	7,617	1	Meadow Pipit	7,806	1
Greylag Goose	7,223	1	Common Buzzard	7,184	1
Eurasian Jackdaw	6,570	1	Greenfinch	6,708	0
Great Cormorant	6,262	1	Great Cormorant	6,564	0
Greenfinch	5,422	0	Black-headed Gull	6,284	0
	Sum of %	81		Sum of %	68
Acoustic observations					
2009			2010		
Species	sum night-time calls	in %	Species	sum night-time calls	in %
Redwing	29,403	29	Song Thrush	61,790	35
Song Thrush	12,712	13	Barnacle Goose	32,836	19
Tree Pipit	9,766	10	Redwing	12,772	7
Greylag Goose	6,688	7	Common Scoter	9,808	6
Blackbird	5,774	6	Blackbird	8,530	5
Robin	5,756	6	Robin	7,180	4
Barnacle Goose	4,569	5	Curlew	5,396	3
Eurasian Jackdaw	2,800	3	Eurasian Wigeon	4,468	3
Dunnock	2,798	3	Tree Pipit	3,856	2
Common Sandpiper	2,403	2	Chaffinch	2,776	2
Chaffinch	2,276	2	Brambling	2,042	1
Common Scoter	1,480	1	Dunnock	1,844	1
Ringed Plover	1,368	1	Greylag Goose	1,726	1
Brambling	1,234	1	Common Sandpiper	1,518	1
Common Heron	1,086	1	Greater White-fronted Goose	1,472	1
Skylark	809	1	Meadow Pipit	1,444	1
Meadow Pipit	695	1	Common Teal	1,314	1
Eurasian Wigeon	623	1	Skylark	1,236	1
Wood Sandpiper	586	1	Brent Goose	1,152	1
Little Ringed Plover	500	0	White Wagtail	916	1
	Sum of %	93		Sum of %	94
Morning census					
2009			2010		
Species	sum morning census individuals	in %	Species	sum morning census individuals	in %
Eurasian Wigeon	6,233	31	Eurasian Wigeon	6,795	29
Greenfinch	1,329	7	Mute Swan	2,345	10
Meadow Pipit	1,140	6	Common Starling	1,155	5
Chaffinch	782	4	Swallow	921	4
Linnet	741	4	Blue Tit	900	4
Wood Pigeon	682	3	Greenfinch	860	4
Swallow	582	3	Chaffinch	648	3
Chiffchaff	544	3	Chiffchaff	559	2
Rook	444	2	Meadow Pipit	551	2
Reed Bunting	434	2	Goldfinch	430	2
Willow Warbler	422	2	Linnet	421	2
Robin	412	2	Robin	359	2
Song Thrush	376	2	Willow Warbler	356	2
White Wagtail	370	2	House Martin	343	1

FEHMARNBELT BIRDS

Yellowhammer	352	2	White Wagtail	316	1
Whitethroat	349	2	Goldcrest	316	1
Yellow Wagtail	327	2	Siskin	299	1
Winter Wren	313	2	Great Tit	285	1
Goldfinch	291	1	Yellowhammer	274	1
Blackbird	278	1	Reed Bunting	261	1
	Sum of %	80		Sum of %	78

The comparison of the different observation methods at Rødbyhavn in 2009 (Table 4.7) provides similar results as for Puttgarden. Birds registered in high numbers by visual observations are not well surveyed by night-time acoustics or morning census, whereas most birds registered by night-time acoustics are poorly covered by the other two methods, except for Tree Pipits, Barnacle Geese and Eurasian Jackdaw as these species migrate both at day- and night-time. During morning census typical non-calling night-time migrants are covered.

Table 4.7 Results of daytime visual (transects), night-time acoustic (calls) observations and morning census at Rødbyhavn onshore station in 2009: the 10 most frequent species per method are listed. Species belonging to more than one list are shaded grey.

Visual observations	sum daytime individuals	in %	sum night-time calls	in %	sum morning census individuals	in %	species group
Common Eider	345,855	30	40	0	0	0	Seaducks
Wood Pigeon	250,836	22	0	0	682	3	Pigeons
Chaffinch sp.*	98,370	9	0	0	290	1	Passerines
Barnacle Goose	69,133	6	4,569	5	1	0	Geese
Chaffinch*	44,508	4	2,276	2	782	4	Passerines
Brent Goose	42,495	4	329	0	0	0	Geese
Dunlin	23,672	2	245	0	0	0	Waders
Siskin	22,412	2	2	0	160	1	Passerines
Wader sp.	20,913	2	0	0	0	0	Waders
Common Starling	17,032	1	12	0	165	1	Passerines
	Sum of %	81					
Acoustic observations			calls				
Redwing	160	0	29,403	29	42	0	Passerines
Song Thrush	190	0	12,712	13	376	2	Passerines
Tree Pipit	15,820	1	9,766	10	178	1	Passerines
Grey Goose	7,223	1	6,688	7	0	0	Geese
Blackbird	26	0	5,774	6	278	1	Passerines
Robin	0	0	5,756	6	412	2	Passerines
Barnacle Goose	69,133	6	4,569	5	1	0	Geese
Eurasian Jackdaw	6,570	1	2,800	3	134	1	Passerines
Dunnock	212	0	2,798	3	201	1	Passerines
Common Sandpiper	18	0	2,403	2	9	0	Waders
			Sum of %	83			
Morning census							
Eurasian Wigeon	5,147	0	623	1	6,233	31	Ducks
Greenfinch	5,422	0	0	0	1,329	7	Passerines
Meadow Pipit	14,775	1	695	1	1,140	6	Passerines
Chaffinch	44,508	4	2,276	2	782	4	Passerines
Linnet	3,489	0	0	0	741	4	Passerines

FEHMARNBELT BIRDS

Wood Pigeon	250,836	22	0	0	682	3	Pigeons
Swallow	8,077	1	18	0	582	3	Passerines
Chiffchaff	8	0	12	0	544	3	Passerines
Rook	3,704	0	200	0	444	2	Passerines
Reed Bunting	3,888	0	435	0	434	2	Passerines
					Sum of %	63	
Totals	1,153,141		100,008		20,390		

* Chaffinch and Chaffinch sp. could be added up, since the proportion of Brambling in the Chaffinch sp. group is small.

4.1.3 Fehmarnbelt - offshore station

Compared to the land stations, the numbers of visual daytime and acoustic night-time observations were lower at Fehmarnbelt offshore as the effort (see above) was lower.

Daytime visual observations were dominated by waterbirds (Table 4.8). Common Eider and Common Scoter represented in both years more than 40 % of the recorded birds. Among the small passerine species only Meadow Pipit, Linnet, Yellow Wagtail, Skylark and Swallow occurred in low numbers within the most frequently observed 20 species. The higher numbers observed in autumn are due to an increased effort compared to spring (see also Appendix A.1). However, Wood Pigeon and Rook were almost exclusively registered in autumn 2009.

Night-time acoustic observations were dominated by Meadow Pipit in 2009, mainly due to a migration event registered in autumn, and by thrushes in both baseline years. It is remarkable that for thrushes the highest migration intensities of all stations were recorded on April 5 and 6, 2009 at this offshore location. During 2010 such a migration event was not registered offshore.

Table 4.8 Results of daytime visual (transects) and night-time acoustic (calls) observations at Fehmarnbelt offshore station: the 20 most frequent species per method are listed. Species ranking in the top 20 in both baseline years are shaded grey.

Visual observations					
2009			2010		
Species	sum daytime individuals	in %	Species	sum daytime individuals	in %
Common Eider	25,858	23	Common Eider	33,542	30
Common Scoter	19,864	18	Common Scoter	17,802	16
Great Cormorant	9,084	8	Herring Gull	5,378	5
Herring Gull	5,450	5	Great Cormorant	5,344	5
Wood Pigeon	5,312	5	Barnacle Goose	2,852	3
Little Gull	3,520	3	Meadow Pipit	2,272	2
Barnacle Goose	2,026	2	Common Gull	2,024	2
Rook	1,924	2	Grey Goose	1,966	2
Black-headed Gull	1,696	2	Eurasian Wigeon	1,652	1
Common Gull	1,694	2	Black-headed Gull	1,182	1
Honey Buzzard	1,648	1	Little Gull	1,064	1
Yellow Wagtail	1,290	1	Linnet	912	1
Brent Goose	1,280	1	Rook	764	1
Meadow Pipit	1,164	1	Swallow	654	1
Greylag Goose	1,092	1	Sparrowhawk	654	1
Dunlin	632	1	Curlew	638	1
Skylark	544	0	Long-tailed Duck	614	1

FEHMARNBELT BIRDS

Lapwing	540	0	Dunlin	582	1
Mute Swan	414	0	Great Black-backed Gull	558	0
Great Black-backed Gull	388	0	Mute Swan	382	0
	Sum of %	77		Sum of %	72
Acoustic observations					
2009			2010		
Species	sum night-time calls	in %	Species	sum, night-time calls	in %
Meadow Pipit	16,336	48	Song Thrush	5,976	38
Redwing	6,232	18	Robin	4,186	26
Song Thrush	4,858	14	Blackbird	1,824	11
Blackbird	1,420	4	Redwing	632	4
Robin	1,280	4	Herring Gull	616	4
Tree Pipit	928	3	Goldcrest	348	2
Skylark	742	2	Skylark	246	2
Eurasian Wigeon	334	1	Barnacle Goose	150	1
Fieldfare	226	1	Tree Pipit	100	1
Brambling	222	1	Curlew	94	1
Reed Bunting	192	1	Common Scoter	92	1
Common Scoter	190	1	Great Black-backed Gull	84	1
Common Sandpiper	132	0	Common Sandpiper	42	0
Mistle Thrush	132	0	Snipe	38	0
Greater White-fronted Goose	100	0	Black-headed Gull	36	0
Oystercatcher	58	0	Oystercatcher	28	0
Chiffchaff	56	0	Siskin	24	0
Yellow Wagtail	34	0	Common Gull	16	0
Wood Sandpiper	32	0	Chaffinch	16	0
Bar-tailed Godwit	30	0	Winter Wren	16	0
	Sum of %	99		Sum of %	92

The ten most common daytime migratory species and the ten most common night-time migratory species registered at the Fehmarnbelt offshore station in 2009 do not overlap (Table 4.9). Song Thrush and Fieldfare were exclusively observed during night-time, but many species were exclusively registered during daytime as well (Table 4.9).

Table 4.9 Results of daytime visual (observations) and night-time acoustic (calls) observations at Fehmarnbelt offshore station in 2009: the 10 most frequent species per method are listed.

Visual observations	sum daytime individuals	in %	sum night-time calls	in %	species group
Common Eider	25,858	23	0	0	Seaducks
Common Scoter	19,864	18	190	1	Seaducks
Great Cormorant	9,084	8	0	0	Cormorants
Duck sp.	8,968	8	4	0	Ducks
Herring Gull	5,450	5	4	0	Gulls
Wood Pigeon	5,312	5	0	0	Pigeons
Goose sp.	4,794	4	2	0	Geese
Little Gull	3,520	3	0	0	Gulls

FEHMARNBELT BIRDS

Barnacle Goose	2,026	2	0	0	Geese
Rook	1,924	2	0	0	Passerines
	Sum of %	78			
Acoustic observations					
Meadow Pipit	1,164	1	16,336	48	Passerines
Redwing	2	0	6,232	18	Passerines
Song Thrush	0	0	4,858	14	Passerines
Blackbird	4	0	1,420	4	Passerines
Robin	66	0	1,280	4	Passerines
Tree Pipit	104	0	928	3	Passerines
Skylark	544	0	742	2	Passerines
Eurasian Wigeon	374	0	334	1	Ducks
Passerine sp.	1,464	1	262	1	Passerines
Fieldfare	0	0	226	1	Passerines
			Sum of %	96	
Totals	110,692		34,042		

4.1.4 Hyllekrog - offshore station

Like at the Fehmarnbelt offshore station, the numbers of visual daytime and acoustic night-time observations were lower at Hyllekrog, and this location was only covered during autumn 2009.

During daytime half of the species counted were waterbirds, the others were passerines and pigeons. During night-time, passerines dominated.

Observations at the Hyllekrog offshore station were meant to investigate whether this location would be a major departure point at the south coast of Lolland during autumn migration and whether flight directions might indicate birds from this location flying towards the planned fixed link over the Fehmarnbelt. Results from this location did not support this. However, it is assumed that this is due to both a lower effort offshore and methodological issues. At an offshore location some 1,000 m from the shore birds are much more difficult to spot than at an onshore location where birds spend more time, are found at lower altitudes and are more concentrated.

Table 4.10 Results of daytime visual (transects) and night-time acoustic (calls) observations at Hyllekrog offshore station in 2009: the 20 most frequent species per method are listed.

Visual observations		
2009		
Species	sum daytime individuals	in %
Common Eider	24,270	22
Passerine sp.	16,818	15
Chaffinch	11,418	10
Great Cormorant	10,156	9
Goose sp.	8,682	8
Wood Pigeon	8,410	8
Duck sp.	6,242	6
Eurasian Wigeon	3,576	3
Meadow Pipit	1,688	2
Barnacle Goose	1,420	1

FEHMARNBELT BIRDS

Herring Gull	1,338	1
Common Scoter	1,210	1
Brent Goose	1,124	1
Honey Buzzard	1,002	1
Lapwing	1,000	1
Greylag Goose	844	1
Yellow Wagtail	706	1
Siskin	660	1
Crow spec	600	1
Greater White-fronted Goose	492	0
	Sum of %	92

Acoustic observations		
2009		
Species	sum night-time calls	in %
Song Thrush	1,626	30
Redwing	1,274	24
Tree Pipit	820	15
Passerine sp.	326	6
Dunlin	282	5
Robin	248	5
Barnacle Goose	246	5
Blackbird	196	4
Yellow Wagtail	82	2
Common Sandpiper	66	1
Goose sp.	50	1
Black-headed Gull	30	1
Common/Arctic Tern	26	0
Meadow Pipit	20	0
Brent Goose	20	0
Sandwich Tern	14	0
White Wagtail	10	0
Snipe	10	0
Common Starling	8	0
Greylag Goose	6	0
	Sum of %	100

4.1.5 Discussion of species composition / occurrence at different stations

The records of 224 bird species in 2009 and 212 in 2010 highlight that the different methods are both suited for and complementary in covering the species diversity occurring in the Fehmarnbelt area. Observations of visible bird migration are restricted to those species migrating during daylight hours and at low altitudes. Audible bird migration is restricted to those species calling during flight and migrating at rather low altitudes. Finally some species, particularly small bird species, were additionally encountered during the morning censuses, e.g. *Sylvia* and *Acrocephalus* warblers and others. However, the species list may not be complete as some rare or cryptic species could have been missed.

Table 4.11 and Table 4.12 depict bird numbers compiled per species groups as recorded by the different survey methods at the field stations in 2009 and 2010.

FEHMARNBELT BIRDS

Table 4.11 Results (summed individuals / calls) of daytime visual (transects), night-time acoustic (calls) observations and morning census at all four field stations in 2009: results are displayed for species groups.

Species group	Puttgarden			Rødbyhavn			Fehmarnbelt offshore		Hyllekrog offshore	
	visual	acoustic	census	visual	acoustic	census	visual	acoustic	visual	acoustic
Divers	645	0	0	1,856	0	0	878	0	50	0
Grebes	1,284	0	0	468	30	3	110	0	86	0
Cormorants	7,902	0	0	6,262	0	0	9,084	0	10,156	0
Hérons	143	114	1	191	1,119	19	124	0	32	4
Storks	6	0	0	2	0	0	0	0	0	0
Swans	1,089	10	0	2,341	52	270	594	0	310	0
Geese	26,710	2,660	12	129,389	12,159	3	9,356	102	12,602	322
Ducks	10,912	2,202	0	10,876	885	6,303	9,746	350	10,522	2
Seaducks	217,358	388	0	359,572	1,712	0	46,176	190	25,518	4
Mergansers	3,491	0	0	2,111	0	0	60	10	206	0
Birds of prey	7,642	8	18	9,944	28	48	2,420	0	1,698	0
Game birds	0	6	0	26	2	6	0	0	0	0
Rails	0	374	2	0	755	2	0	0	0	0
Cranes	1,202	0	0	1,018	0	0	24	0	0	0
Waders	4,229	10,506	0	78,972	7,298	105	2,256	316	2,020	358
Skuas	36	0	0	66	0	0	26	0	18	0
Gulls	15,126	10	169	9,975	2	8	14,930	20	4,010	30
Terns	4,029	50	0	4,205	0	3	1,274	4	542	40
Pelagic species	80	0	0	72	0	0	120	0	52	0
Pigeons	164,012	0	1,296	255,242	0	724	5,550	0	8,712	0
Cuckoos	4	0	1	10	0	64	0	0	0	0
Owls	2	0	0	0	30	2	0	0	0	0
Swifts	1,398	0	0	1,491	0	5	100	0	28	0
Passerines	74,895	34,318	4,519	278,993	75,538	12,792	7,864	33,050	34,096	4,618
	542,201	50,656	6,020	1,153,139	100,008	20,390	110,692	34,042	110,658	5,378

Table 4.12 Results (summed individuals / calls) of daytime visual (transects), night-time acoustic (calls) observations and morning census at all three field stations in 2010: results are displayed for species groups.

Species group	Puttgarden			Rødbyhavn			Fehmarnbelt offshore	
	visual	acoustic	census	visual	acoustic	census	visual	acoustic
Divers	678	0	0	1,824	0	0	1,074	0
Grebes	1,322	0	0	410	18	3	428	0
Cormorants	8,500	0	0	6,564	0	0	5,344	0
Hérons	196	350	0	208	764	17	106	2
Storks	42	0	0	68	0	0	0	0
Swans	964	920	0	3,094	454	2,345	596	2
Geese	76,258	13,058	0	121,526	38,370	3	10,680	1,150
Ducks	15,776	4,080	6	11,394	5,860	6,967	9,158	44
Seaducks	284,256	5,226	0	342,454	10,072	0	52,120	98
Mergansers	1,856	0	0	3,758	0	1	322	0
Birds of prey	8,858	0	32	14,056	0	55	1,506	0

FEHMARNBELT BIRDS

Species group	Puttgarden			Rødbyhavn			Fehmarnbelt offshore	
	visual	acoustic	census	visual	acoustic	census	visual	acoustic
Game birds	0	0	0	0	14	0	0	0
Rails	0	880	0	0	1,116	151	0	0
Cranes	750	0	0	654	0	0	70	0
Waders	6,810	17,298	0	82,340	12,750	42	2,912	312
Skuas	40	0	0	80	0	0	26	0
Gulls	11,438	492	843	10,284	232	2	14,114	836
Terns	5,202	316	0	6,032	34	1	1,622	0
Pelagic species	90	0	0	48	0	0	274	0
Pigeons	108,566	0	708	314,350	0	2	6	0
Cuckoos	14	0	0	6	0	61	0	0
Owls	2	0	0	2	0	1	0	0
Swifts	6,862	0	0	2,634	0	89	46	0
Passerines	65,110	128,826	6,237	500,578	105,646	13,892	11,876	13,446
	603,590	171,446	7,832	1,422,426	175,330	23,659	112,280	15,890

Marked differences in bird numbers were observed between the different survey locations during both years of the baseline investigations (Table 4.11, Table 4.12). In general, land stations yielded higher overall numbers than the offshore stations, and the Danish land station in Rødbyhavn revealed considerably higher numbers than the Puttgarden land station on Fehmarn. While the first finding is attributed to a higher effort and different observation conditions at the land stations compared to the offshore locations, migration intensities also reflect differences between land stations and seasons (chapter 4.2).

According to the results of two years of baseline investigations the spring seaduck migration seems to occur mainly in the northern part of the Fehmarnbelt, whereas during autumn seaduck migration appears comparably higher in the southern part of the Fehmarnbelt. A similar seasonal distribution pattern could also be observed for divers and terns. Seaduck numbers in the central Fehmarnbelt were clearly lower.

For geese a major migration event was registered during spring 2009 with considerably higher numbers recorded at Rødbyhavn (n=46,711) than at Puttgarden (n=3,024). Migration directions of SE (see below) suggest that these birds flew along the Lolland coast and may not have crossed the Fehmarnbelt. During the subsequent spring season in 2010 similar high numbers of Barnacle Goose were not observed (Rødbyhavn: n=25,305, Puttgarden: n=2,146). The numbers of migrating Barnacle Geese registered during autumn differed between the two years. During the autumn of 2009, 11,222 and 22,816 Barnacle Geese were observed at Puttgarden and Rødbyhavn, respectively, whereas in autumn 2010 46,836 and 34,062 individuals were recorded, indicating that the Barnacle Goose autumn migration was well covered in 2010.

Both years of baseline investigations revealed also substantial differences in wader numbers occurring at both sides of the Fehmarnbelt (Table 4.11, Table 4.12). Higher numbers recorded at the field station in Rødbyhavn resulted mainly from high numbers observed in late May. Migration directions recorded towards E and SE (see below) suggest that these birds might not have been crossing the Fehmarnbelt, explaining lower numbers observed at the Fehmarn coast.

FEHMARNBELT BIRDS

Numbers of passerines counted at the different stations do reflect observation efficiency as well as migration behaviour. Birds starting from the coast are easier to spot than birds arriving from offshore, and they may also fly higher. Passerines are registered in high numbers at the departure coast, e.g. some 50,000 during spring 2009 at the Fehmarn coast compared to some 4,000 at the Lolland coast. In turn, during autumn 2009, some 270,000 were recorded at the Lolland coast and some 25,000 at the Fehmarn coast. Thus, in this case the numbers of observations at the departing coast are generally a factor 10 higher compared to the arrival coast. These results were supported by the additional data set from 2010 with some 30,000 passerines in Puttgarden during spring and some 6,000 in Rødbyhavn and during autumn some 500,000 at Rødbyhavn and some 30,000 in Puttgarden. Radar data on migration intensity obtained by the 'Superfledermaus' confirm these results of the visual observations. During spring the average migration intensity was higher at Puttgarden than at Rødbyhavn, whereas during autumn the average migration intensity was higher at Rødbyhavn. However, orographic features of the different locations may also affect detection probability.

Pigeons, unlike passerines, were occurring in high numbers at both coasts of the Fehmarnbelt during autumn, in 2009 as well as in 2010.

In spring and autumn season 2009, birds of prey were recorded in similar high numbers at the Fehmarn coast (3,300 and 4,300), but differences between seasons observed at Lolland were large (1,600 and 8,300). At the offshore station in the central Fehmarnbelt very few birds of prey were registered during spring, but larger numbers during autumn (2,300). Also autumn observations at Hyllekrog obtained comparably high numbers of birds of prey (1,700). In 2010 this pattern changed slightly as at Fehmarn during spring (2,300) where fewer birds were registered than in autumn (6,500). For Rødbyhavn the differences between spring (2,400) and autumn numbers (11,900) were confirmed by second year of baseline investigations.

Analyses of the night-time acoustic observations depicted a pattern comparable to the visual observations. In 2009 more calls were registered at the Lolland coast, and these are basically on account of passerines and geese, coinciding with the tendencies of the visual observations. In 2010 at both land stations the number of recorded calls was nearly the same (Puttgarden 171,000, Rødbyhavn 175,000). However, at all observed stations passerine calls were generally less numerous during spring than during autumn. As mentioned above, at the central Fehmarnbelt location high intensities were recorded during spring 2009, owing to considerably higher numbers of Song Thrush and Redwing calls. This pattern was not confirmed for this location in the subsequent spring season in 2010.

Differences in bird numbers derived from the morning censuses at the both land stations can be explained by the more diverse habitat in Rødbyhavn compared to Puttgarden. Morning census area at Rødbyhavn included also e.g. water bodies, supporting an additional range of species like ducks.

4.1.6 Comparison of own results with other migration observation stations

Migration data of observation stations covered by German, Danish and Swedish Ornithological Organisations are compiled from Fehmarn, (Germany - OAG), Gedser, Hyllekrog and Nakskov Fjord (Denmark - DOF), Falsterbo (Sweden - SkOF)) for the period 2000-2009 and analysed for additional information about migration events at the Fehmarnbelt. After an initial screening of these external data, it was decided to leave Gedser, Hyllekrog and Nakskov Fjord data out

FEHMARNBELT BIRDS

(Denmark – DOF), as effort and methods at these stations are not comparable to the strict migrating bird counts at the other stations (see also Appendix B.6). Even then, with results from only Fehmarn (Germany – OAG) and Falsterbo (Sweden – SkOF) left, comparisons across stations and organisations are not straight forward. Observations e.g. at Fehmarn (OAG) may include several observation points and may be biased towards the “good” observation spots and periods. On the other hand, temporal coverage may be substantially lower than at own field stations. However, while it is assumed, that volunteer organisations strive for coverage of the main migration events, it is considered that Fehmarn OAG results can be used for comparisons. Results from Falsterbo, based on standardized effort and methods with even daily results during autumn, are also comparable.

A comparison of spring migration total sums for 2009 show that the baseline observations from Fehmarnbelt provide a comprehensive overview of the migration occurring in the area and confirms a good to very good coverage of most species groups (Table 4.13). For all species groups, the accumulated data from the visual observations at the three baseline field stations yield higher results than the OAG Fehmarn results. Obviously, this may be due to a higher effort, as volunteer organisations concentrate on autumn, or more observations due to the summation of observations across stations.

Table 4.13 Results from visual observations from all three baseline field stations in spring 2009 in comparison with results from Fehmarn (OAG), spring 2009. Accumulated sums are compared per season and species group. Values from other stations higher than values from baseline stations are marked in red.

Totals of spring 2009	own data	Fehmarn (OAG)	Falsterbo (SkOF) – no data in spring
Divers	2,645	15	
Grebes	1,307	5	
Cormorant	6,950	153	
Hérons	75	0	
Stork	6	0	
Swans	2,133	136	
Geese	98,443	488	
Ducks	4,201	87	
Seaducks	356,126	6,478	
Mergansers	3,935	2	
Birds of prey	3,314	1,250	
Crane	1,128	1,050	
Wader	77,426	57	
Skuas	74	0	
Gulls	22,903	156	
Terns	4,429	1	
Pelagic species	98	11	
Pigeons	42,882	9,573	
Cuckoo	8	0	
Owls	2	0	
Swift	401	0	
Passerines	50,290	12,814	

FEHMARN BELT BIRDS

For autumn 2009, the baseline observations yield higher numbers for all species groups compared to the Fehmarn (OAG) observations, with the exception of Common Crane. Compared to Falsterbo (SkOF), the baseline observations yield the highest numbers for grebes, cormorants, storks, swans, ducks and sea ducks, mergansers, gulls, terns, pelagic species, cuckoos and swifts (Table 4.14). For herons, geese, skuas and terns, the baseline results are still comparable with the Falsterbo data. In turn, Falsterbo results are considerably higher for the species groups of divers, birds of prey, cranes, waders, pigeons and passerines. At Falsterbo, with a continuous and comparable effort throughout the autumn season, accumulated numbers of recorded birds of prey are more than 4-times, of migrating passerines about 3-times and of migrating pigeons 1.5-times higher than observed during the baseline investigations. These differences might be due to the different observation effort at the two stations, since at Falsterbo observations are carried out every day. However, differences may reflect the phenomenon, that not all birds leaving SW Sweden pass the Fehmarnbelt.

Table 4.14 Results of daytime visual observations from all three FEBI stations in autumn 2009 (FEBI data) in comparison with data from Fehmarn (OAG) and Falsterbo (SkOF): species groups. Values from other stations higher than values from own stations are marked in red.

Totals of autumn 2009	FEBI data	Fehmarn (OAG)	Falsterbo (SkOF)
Divers	734	22	925
Grebes	555	20	82
Cormorants	16,298	1,169	NN
Herons	116	31	176
Storks	2	0	1
Swans	1,891	139	1,054
Geese	67,012	16,964	69,537
Ducks	27,333	1,789	12,538
Seaducks	266,980	55,326	79,412
Mergansers	1,727	241	1,424
Birds of prey	8,347	3,647	36,379
Cranes	252	254	5,020
Waders	8,031	2,548	12,429
Skuas	54	8	59
Gulls	17,128	367	8,591
Terns	5,079	345	5,842
Pelagic species	174	0	50
Pigeons	251,038	12,602	325,727
Cuckoos	4	2	0
Owls	0	0	0
Swifts	1,318	863	976
Passerines	274,812	89,743	794,919

Another comparison shows daily maxima for selected species from the baseline observations at the Fehmarn and Lolland field stations in comparison to OAG observations at Fehmarn (Table 4.15 and Table 4.16). Here, OAG data cover a period of ten years (2000-2009), whereas the baseline data were obtained in

FEHMARNBELT BIRDS

2009 and 2010, only. Therefore it is expected that the OAG dataset provides higher daily maximum values due to the longer covered time period.

For the spring season, a comparison of the baseline data from the Puttgarden field station and the OAG data show that daily maxima mostly lie within the same range. However, maximum numbers recorded by OAG are for a number of species slightly higher, and for Greater White-fronted Goose, Honey Buzzard, Common Buzzard, Golden Plover and Siskin (Table 4.15). The numbers registered of Common Scoter and of Wood Pigeon are in contrast higher for the baseline observations. For waterbird species daily maxima on Lolland were remarkably higher for the baseline observations compared to the OAG data. This might be due to different migration intensities occurring at the different coasts of the Fehmarnbelt, as shown by own observations.

*Table 4.15 Daily maxima recorded during daytime visual observations at Puttgarden and Rødbyhavn in spring 2009 and 2010 in comparison with OAG data from Fehmarn (2000-2009). Values from OAG higher than values from own stations are marked in red. Counts summed up over several observation points (Fehmarn (OAG)) are marked with *.*

Daily Maxima	Puttgarden (own data)	Fehmarn (OAG)	Rødbyhavn (own data)
Spring	2009 and 2010	2000-2009	2009 and 2010
Mute Swan	94	134	310
Barnacle Goose	2,006	2,760	23,900
Brent Goose	26	2	25,504
Greater White-fronted Goose	760	3,347*	858
Eurasian Wigeon	268	310	828
Common Eider	4,837	5,710	56,894
Common Scoter	3,080	1,053	2,992
Honey Buzzard	146	522	360
Common Buzzard	504	1,000	276
Sparrowhawk	82	101*	74
Golden Plover	50	900	320
Dunlin	44	128	8,140
Lapwing	250	99	72
Little Gull	108	191	1,762
Black-headed Gull	900	481	322
Common Tern	28	17	208
Wood Pigeon	15,658	5,000	9,000
Common Starling	1,696	1,434	76
Siskin	146	6,580	120

For some species, e.g. Eurasian Wigeon and Common Eider similar numbers are reported during the autumn seasons. However, the OAG dataset suggests higher daily maxima for a number of species e.g. Barnacle Goose, Brent Goose, birds of prey, gulls and Common Starlings (Table 4.16). For Common Scoter and Wood Pigeon, the baseline observations show about 2-times higher daily maxima than the OAG data.

There are two reasons, why the OAG data may produce higher daily maxima. First, during expected migration events, volunteers cover the most promising observation points along the Fehmarn coast and in some cases even data from several observation points are added (marked with an * in the tables). This has

FEHMARNBELT BIRDS

been the case e.g. for the spring count of Greater White-fronted Goose (Table 4.15), for which data have been added together from 4 stations. However, the highest single count of 2,196 Greater White-fronted Goose is still considerably different from the baseline data. Also the autumn count of Barnacle Goose at Fehmarn (Table 4.16) contains numbers added together from four stations and here the highest count of 21,480 is comparable to the highest value of the baseline data. Secondly, the baseline observations covering the two years of 2009 and 2010 are not likely to have registered as many major migration events of these species as the 10 year observations by OAG.

Compared to the results from Falsterbo, the baseline data from Fehmarnbelt yield lower daily maxima for geese, birds of prey, waders, gulls, pigeons and passerines, but higher numbers for seaducks. This points out, that the daily coverage at Falsterbo may produce higher numbers, but more likely that the species culminating at Falsterbo will not show the same culmination effect at the Fehmarnbelt baseline stations. However, with regard to seaducks, the high importance of the Fehmarnbelt as a funnelling migration corridor is pointed out again.

*Table 4.16 Daily maxima recorded during daytime visual observations in Puttgarden and Rødbyhavn in autumn 2009 and 2010 in comparison with OAG data from Fehmarn (2000-2009) and SkOF data from Falsterbo. Values from other stations higher than values from own stations are marked in red. Counts summed up over several observation points (Fehmarn (OAG)) are marked with *.*

Daily maxima	Puttgarden (FEBI)	Fehmarn (OAG)	Rødbyhavn (FEBI)	Falsterbo (SkOF)
Autumn	2009 and 2010	2000-2009	2009 and 2010	2000-2009
Mute Swan	56	25	166	228
Barnacle Goose	22,620	57,928*	10,016	40,450
Brent Goose	2,330	7,016*	474	12,380
Greater White-fronted Goose	664	382*	320	440
Eurasian Wigeon	2,172	2,646	3,858	5,920
Common Eider	52,512	50,000	15,108	25,715
Common Scoter	5,548	2,752	1,608	2,310
Honey Buzzard	520	1,916	1,466	1,987
Common Buzzard	1,128	2,484*	5,036	7,923
Sparrowhawk	314	1,362*	296	2,333
Golden Plover	300	1,350	240	400
Dunlin	242	430	404	3,393
Lapwing	180	640	258	690
Little Gull	1,434	3,176	226	462
Black-headed Gull	766	2,420	806	2,552
Common Tern	198	530	72	972
Wood Pigeon	61,166	28,464	109,408	137,500
Common Starling	874	6,175*	5,090	11,770
Siskin	1,510	2,290	24,426	16,080

4.2 Migration intensities and phenologies

Migration intensities describe the number of individuals or in the case of the acoustic observations the number of registered calls per time unit. Daytime migration intensities are best described by visual observations (Chapter 0), while surveillance radar results are not conclusive, as flocks cannot be distinguished

FEHMARNBELT BIRDS

from single individuals. Further it is known that during daytime birds frequently migrate in flocks, such as geese, ducks, but also pigeons and some passerine species. In turn, night time intensities can only be recorded by acoustic observations, applying to species which call and fly at low altitudes, by vertical surveillance radar and fixed pencil beam radar (Chapter 4.2.2). Migration intensities do play a role when assessing the importance of coastal locations like Rødbyhavn and Puttgarden for bird migration and can be analysed in dependence on weather, in particular wind conditions (Chapter 5.1).

Migration in the Fehmarnbelt in the two baseline years 2009 and 2010 started as early as February, depending on the strength of winter. Once the ice had melted or temperatures start to rise, seaducks started to migrate towards the Baltic and continue towards their breeding locations; peaks are generally around end of March. Divers, grebes and mergansers also migrated during March. Then songbird and other landbird migration slowly started. While Common Buzzard came through already in March, migration only becomes more intensive during April, including some wader, duck and geese migration. During May, in particular Honey Buzzard and other long-distance migrants came through, and towards the end of May a short period of wader and other arctic breeder migration occurred.

June and July saw some movements with regard to moulting waterbirds, such as Common Eider and Mute Swan, with Common Scoter moving in somewhat later.

Late July and in August autumn migration started, again with the long-distance migrants, most spectacular Honey Buzzard and other birds of prey. A number of passerine species moved through in September as well as other birds of prey species, while waterbird migration will also take place. Songbird migration started with the long-distance migrants, but typically cumulated around October 10 with finches and other passerines; another peak occurred in November with the thrushes, however, in 2009 these species came after mid-November due to the warm autumn weather. For a detailed overview see Appendix A.6.

FEHMARNBELT BIRDS

4.2.1 Migration intensities as registered by visual and acoustic observations

Puttgarden onshore station

The overall migration intensity during daytime at the Puttgarden onshore station shows some peaks (> 1,000 ind./h) during March 2009 and 2010, and in early April (only in 2009), and stayed comparably low during the remaining spring and summer months (Figure 4.1).

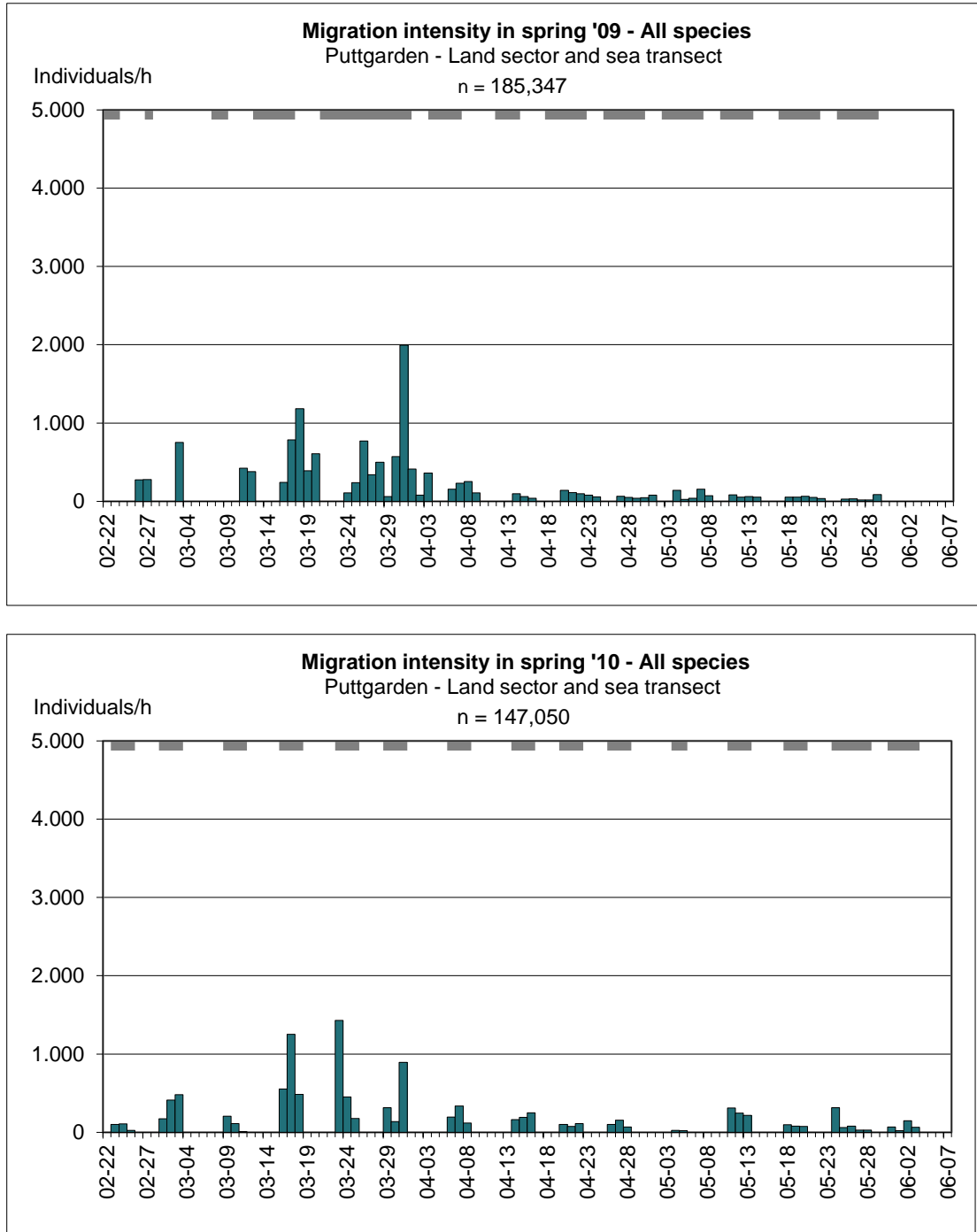

Figure 4.1 Spring 2009 (upper chart) and 2010 (lower chart): Daytime visual observations at Puttgarden onshore station; migration intensity per day in ind./h counted during daytime; days covered with observations are indicated in grey on the upper axis.

FEHMARNBELT BIRDS

From late September to mid (2009) or even end (2010) October some large migration peaks were recorded consisting mainly of waterbirds (seaducks, especially Common Eider) and pigeons. A high peak occurred during late September in 2010 and thus earlier as in 2009. Medium migration intensity occurred until mid-November (Figure 4.2).

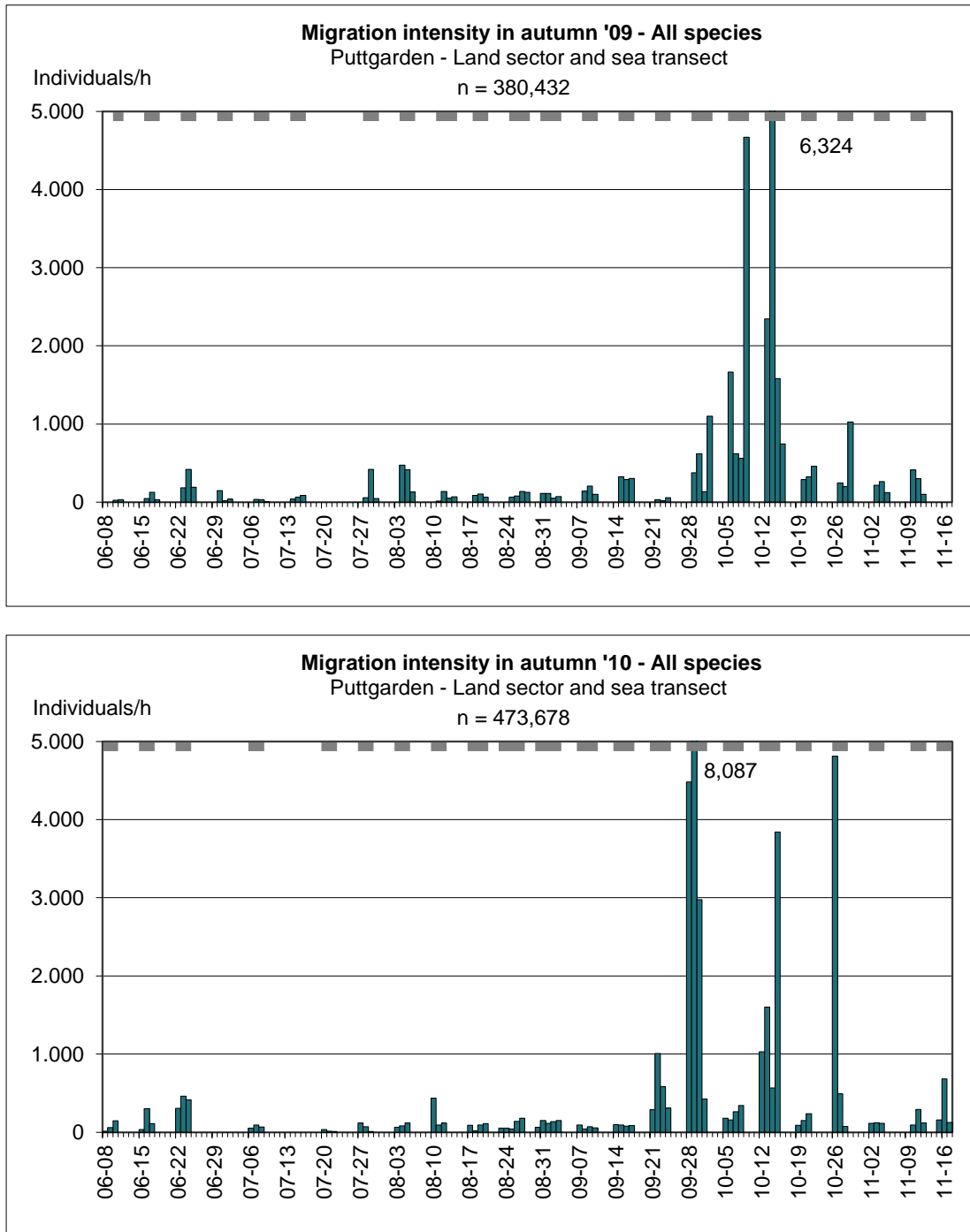

Figure 4.2 Summer and autumn 2009 (upper chart) and 2010 (lower chart): Daytime visual observations at Puttgarden onshore station: migration intensity per day in ind./h; days covered with observations are indicated in grey on the upper axis.

FEHMARNBELT BIRDS

Night-time migration intensities during spring, as identified by night-time acoustic observations, were markedly different in 2009 compared to 2010, with several high intensity nights in 2010 in March due to thrushes and in May due to Tree Pipits (Figure 4.3). Towards autumn, intensities increased from August on (Figure 4.4). Again, a peak of Tree Pipits occurred on August 28, 2010. Also, some nights with intensive migration of thrushes were registered in both years between late September and early November. Calling intensities were generally lower at the inland station compared to the harbour station (Figure 4.4). However, a Golden Plover peak was recorded in early September 2009 at the inland station, which was not registered at other stations, and in 2010 a peak in the night of October 15 consisting of Chaffinches (early morning), Redwings and Reed Bunting was also not registered in this intensity at the harbour station.

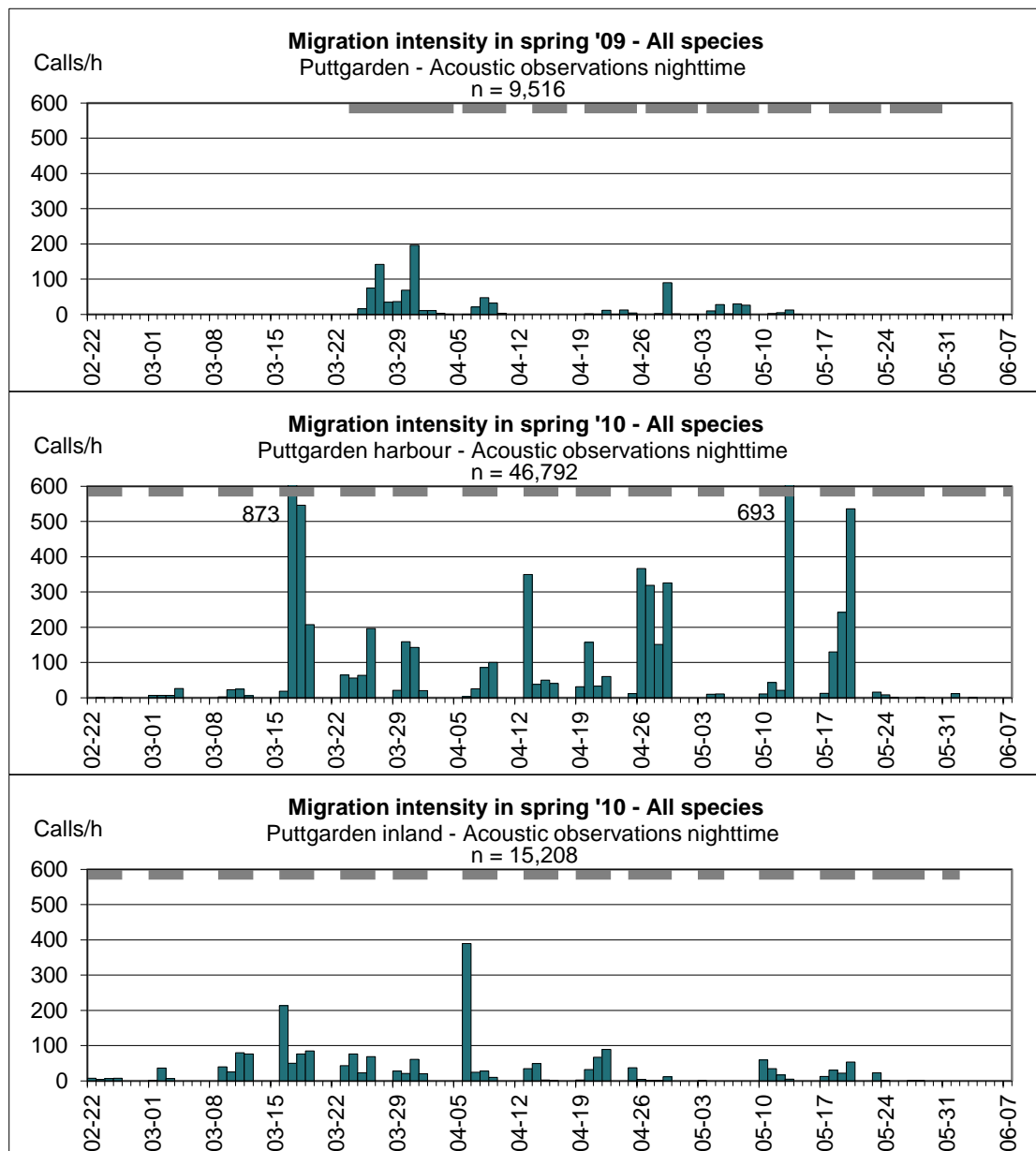

Figure 4.3 Spring night-time acoustic observations at Puttgarden harbour station 2009 (top) and 2010 (middle) and 2010 at the inland station (bottom): migration intensity per night in calls/h; nights covered with observations are indicated in grey on the upper axis.

FEHMARNBELT BIRDS

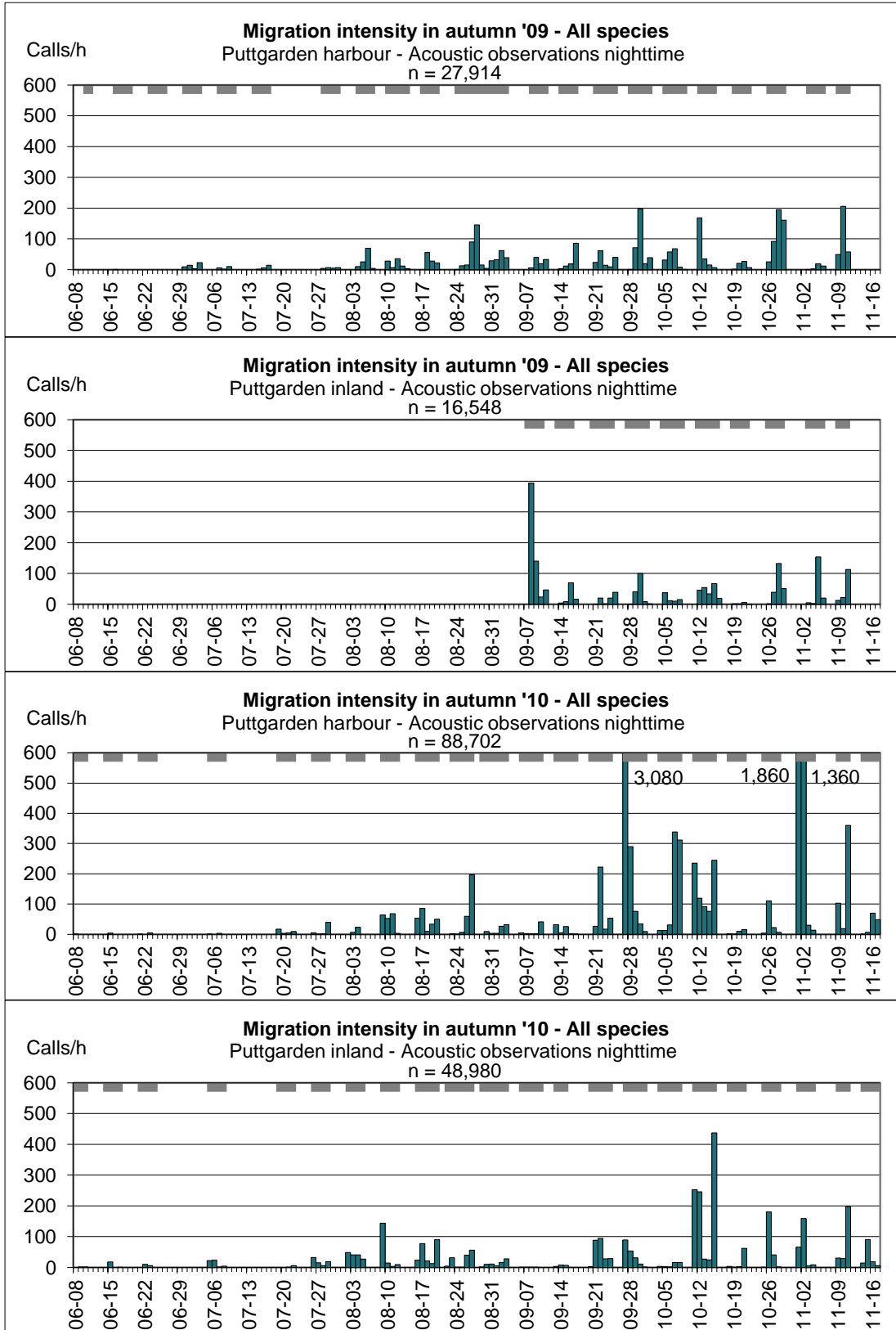

Figure 4.4 Summer / autumn 2009 (upper two charts) and 2010 (lower two charts): Night-time acoustic observations at Puttgarden harbour and inland station: migration intensity per night in calls/h; nights covered with observations are indicated in grey on the upper axis.

Rødbyhavn onshore station

Migration intensities during two years of baseline investigations at the onshore station in Rødbyhavn in spring showed similar patterns as observed at Puttgarden (Figure 4.5). However, in both years during March and May higher and marked peaks occurred, mostly on account of intensive seaduck and wader migration, respectively. During June and July intensities were low. More regular migration was recorded from mid-August in 2009 and in 2010 some ten days later, followed by large migration peaks starting in the third decade of September and persisting throughout October (Figure 4.6). In 2010, true peaks are somewhat earlier (late September) as in 2009, just as at Puttgarden, and higher migration intensities continued until mid-November, while for 2009, it is likely that large parts of migration of e.g. thrushes and pigeons occurred after the 2009 autumn field season due to overall high temperatures in November (Figure 4.6) (see also Appendix A.6).

FEHMARNBELT BIRDS

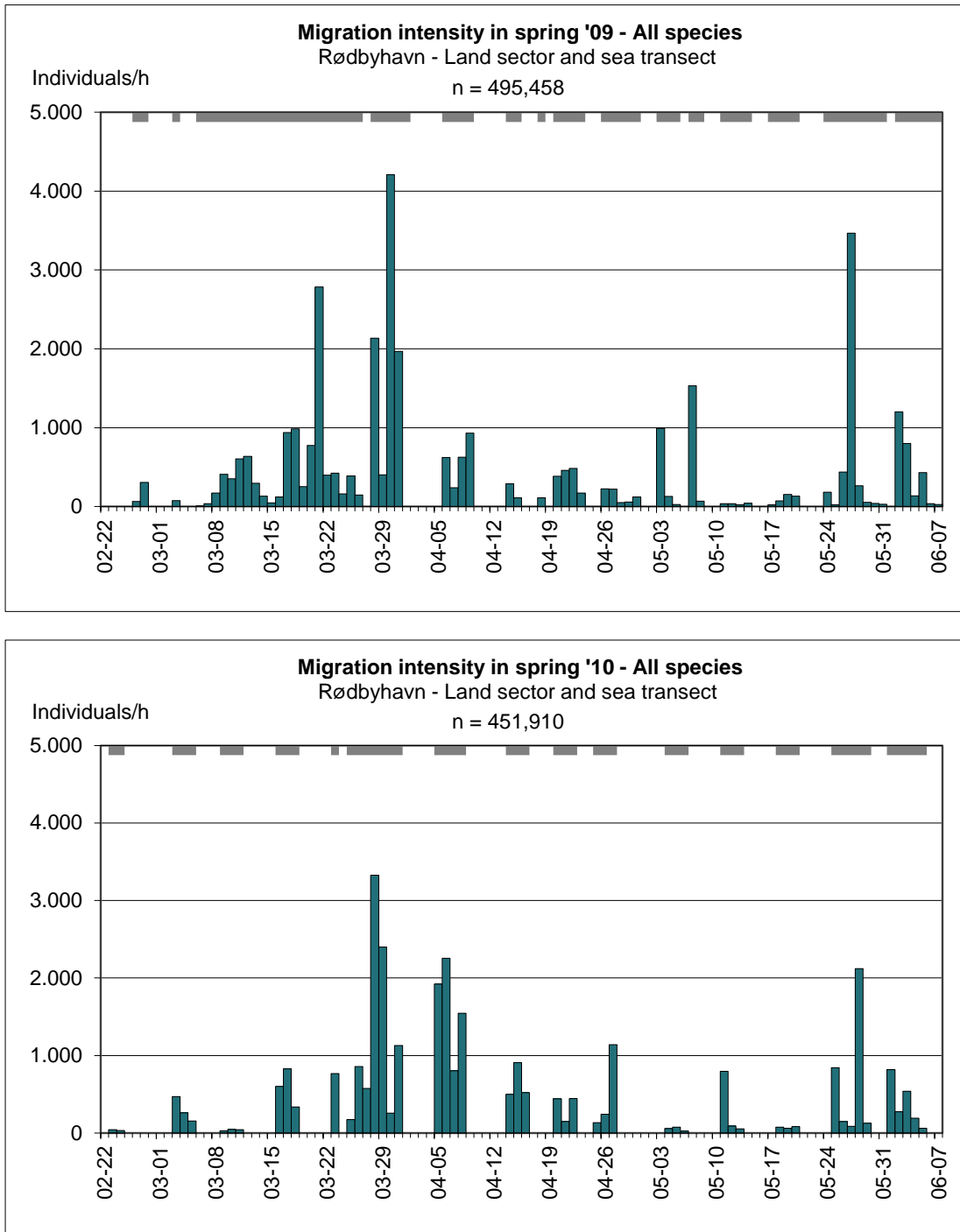

Figure 4.5 Spring 2009 (upper chart) and 2010 (lower chart): Daytime visual observations at Rødbyhavn onshore station: migration intensity per day in ind./h; days covered with observations are indicated in grey on the upper axis.

FEHMARNBELT BIRDS

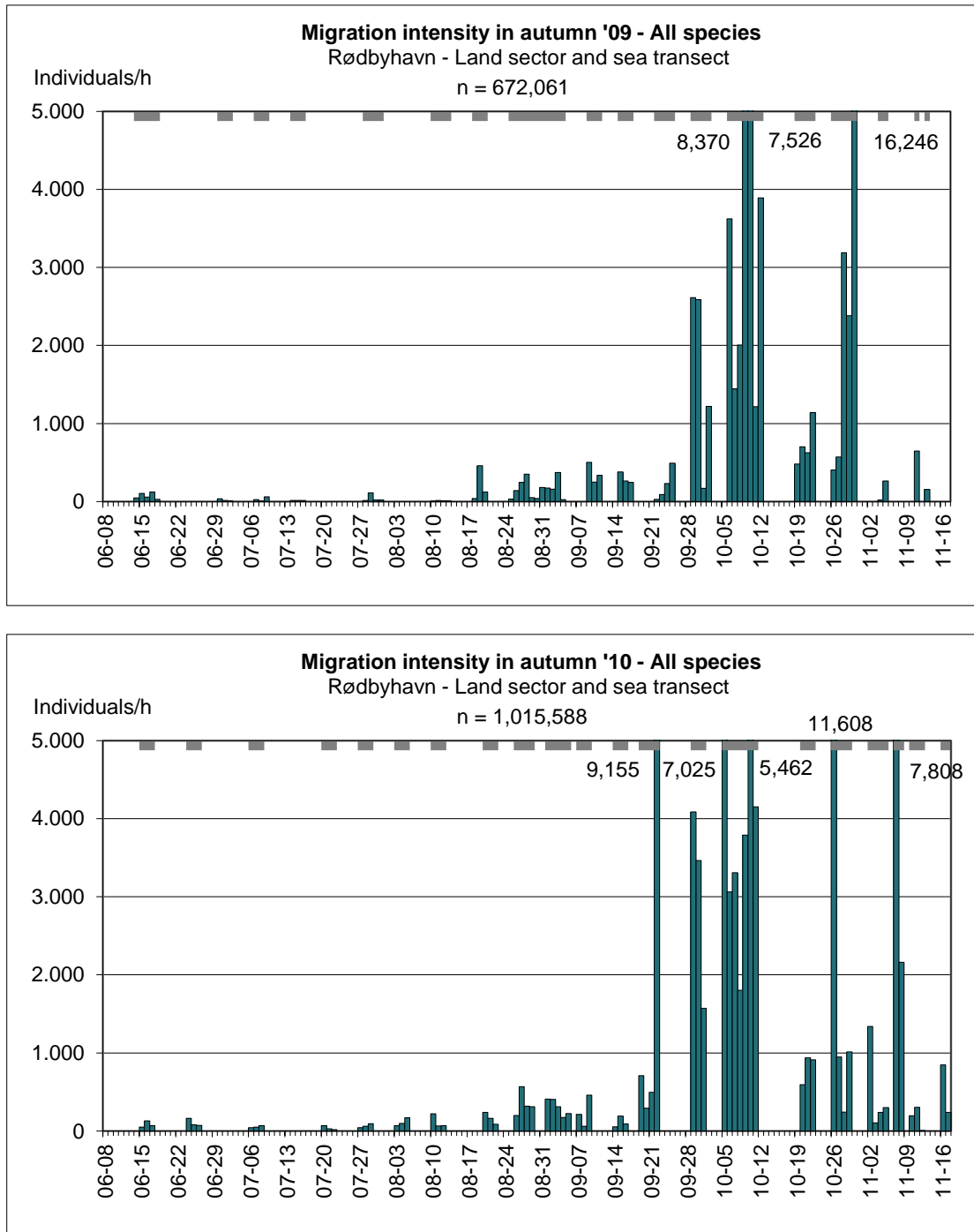

Figure 4.6 Summer and autumn 2009 (upper chart) and 2010 (lower chart): Daytime visual observations at Rødbyhavn onshore station: migration intensity per day in ind./h; days covered with observations are indicated in grey on the upper axis.

Night-time migration intensities in spring 2009 were highest in late March and early April (Figure 4.7). In 2010, peak intensities appeared earlier than in 2009, and lasted into May (Figure 4.7). In mid-May Barnacle Geese contributed during two nights with intense calling activity. During autumn, peak days of night-time calling intensities occurred frequently on top of a medium intensity throughout

FEHMARNBELT BIRDS

the season (Figure 4.8). Remarkable peaks were dominated by thrushes in October 2009 and a peak of Tree Pipits in late August 2009, while five peaks in autumn 2010 were dominated by thrushes. Autumn night-time migration intensities were higher at Rødbyhavn compared to Puttgarden. Data show, that in particular passerine autumn migration is high at this location; data from visual observations show the same tendency. Migration intensities at the inland station show the same patterns compared to the harbour acoustic station, but with lower overall intensities (Figure 4.8). Whether this is a true difference in migration intensity or a bias due to an increased calling activity when birds “reach” the coast and lit structures, is yet unsolved.

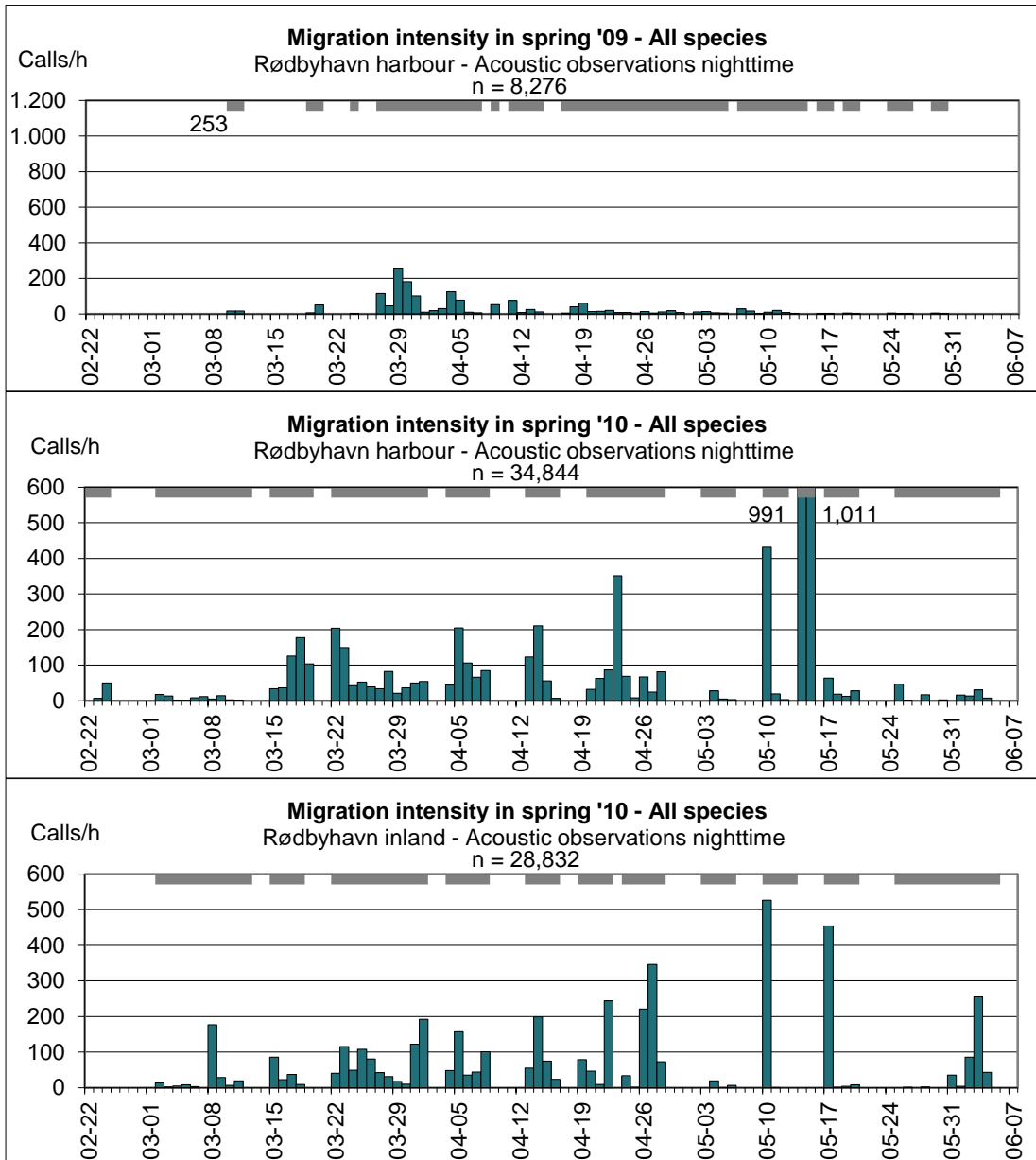

Figure 4.7 Spring night-time acoustic observations at Rødbyhavn harbour station 2009 (top) and 2010 (middle) and 2010 at the inland station (bottom): migration intensity per night in calls/h; nights covered with observations are indicated in grey on the upper axis.

FEHMARNBELT BIRDS

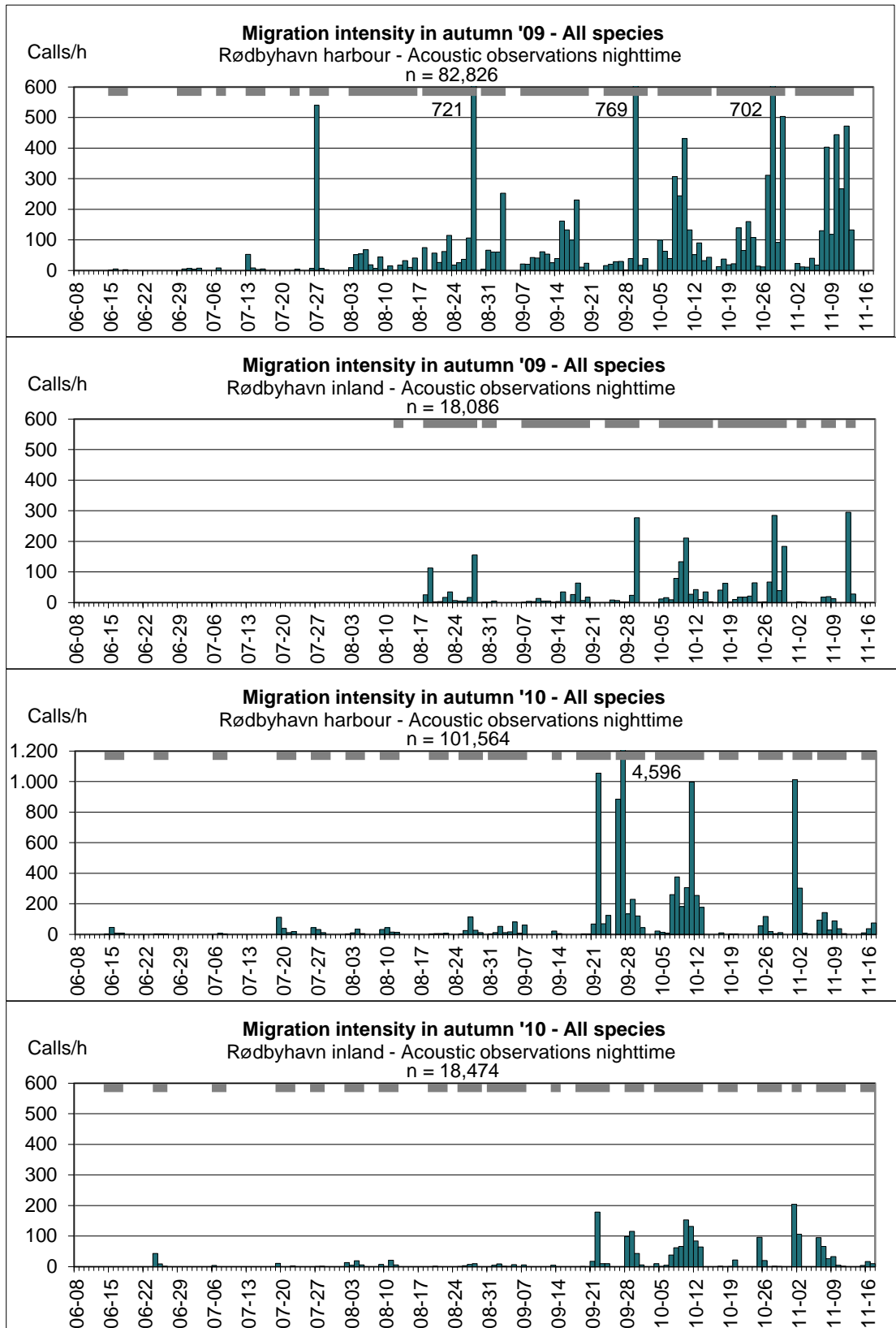

Figure 4.8 Summer and autumn 2009 (upper two) and 2010 (lower two): Night-time acoustic observations at Rødbyhavn harbour and inland station; migration intensity per night in calls/h; nights covered with observations are indicated in grey on the upper axis.

FEHMARNBELT BIRDS

Fehmarnbelt offshore station

For the Fehmarnbelt offshore station, the overall lower observation effort compared to the land stations must be taken into account. Migration intensities during daytime showed regular activity during observation days, however, intensities were considerably (factor 5) lower than at both land stations (Figure 4.9, Figure 4.10). On one hand some migration peaks might have been missed due to the lower effort offshore. On the other hand, detection of e.g. passerines and pigeons is more difficult at the ship platform, where the use of telescopes is limited, and observation quality is strongly influenced by adverse weather conditions (see also chapter 4.1.5). With regard to waterbirds, regular occurrences were recorded, but migration intensities of seaducks were markedly lower compared to the land stations in both seasons.

FEHMARNBELT BIRDS

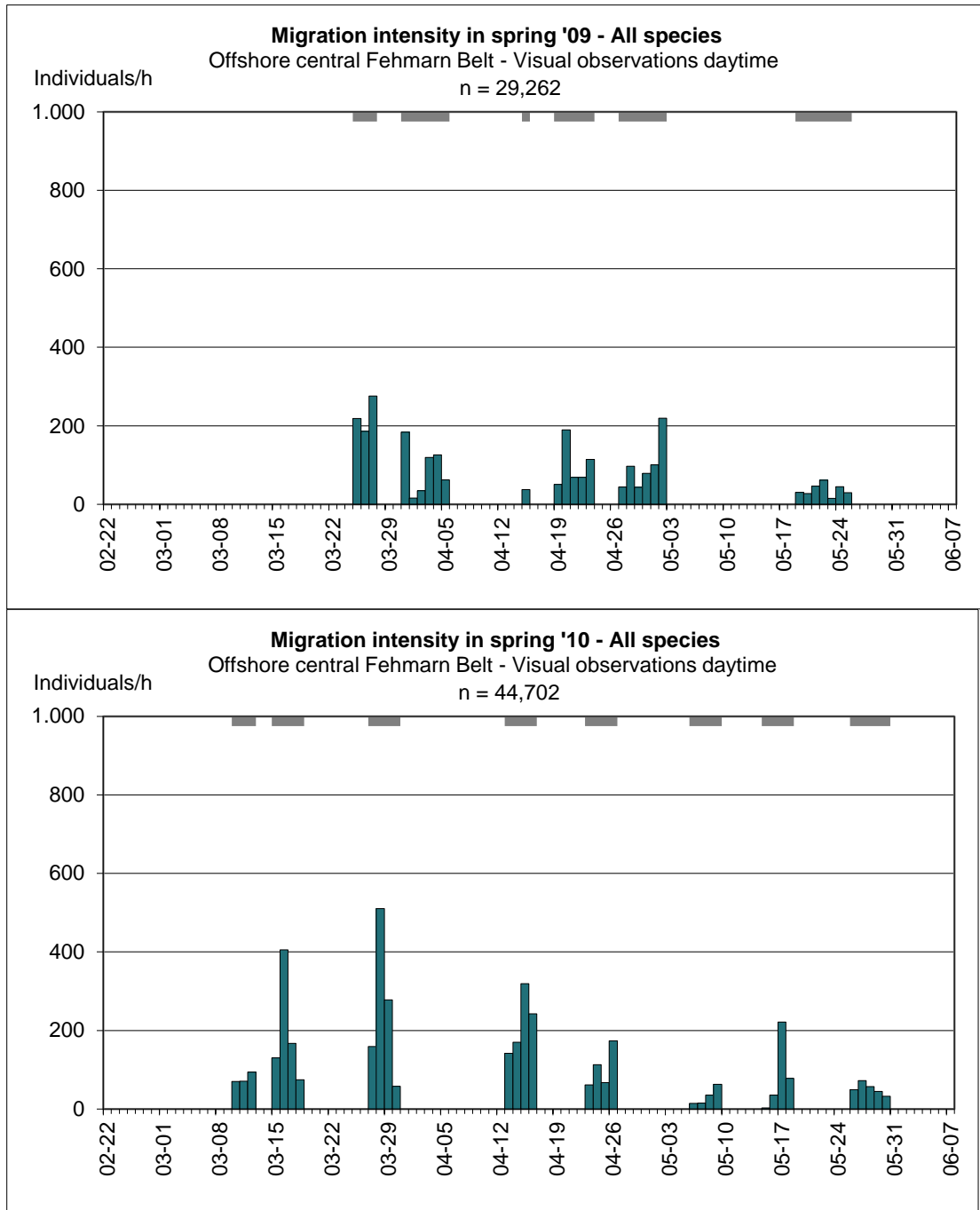

Figure 4.9 Spring daytime visual observations at the Fehmarnbelt offshore station in 2009 (upper chart) and 2010 (lower chart): migration intensity per day in ind./h. Scale of the y-axis is 1,000 compared to 5,000 at the onshore locations; days covered with observations are indicated in grey on the upper axis.

FEHMARNBELT BIRDS

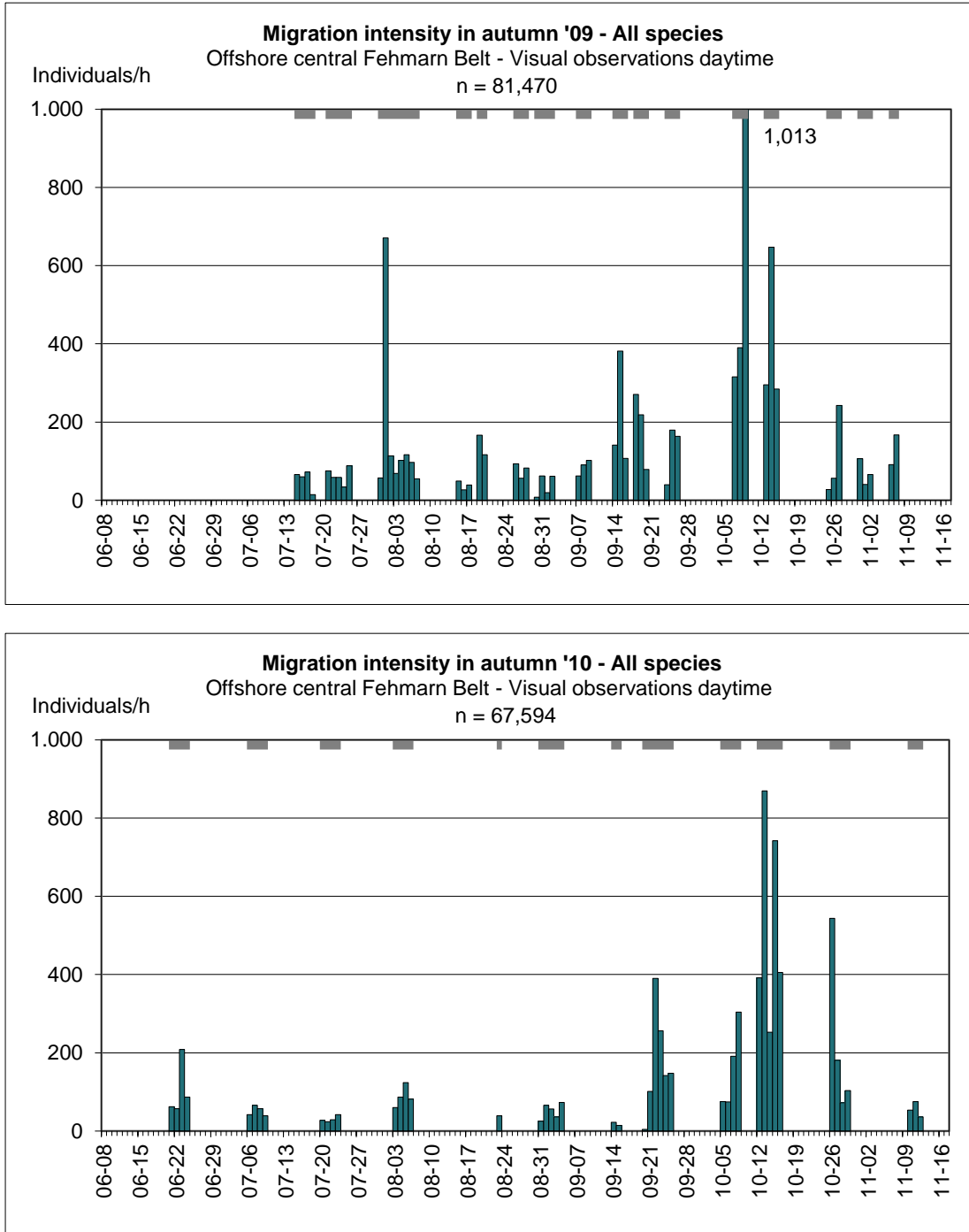

Figure 4.10 Summer and autumn daytime visual observations at the Fehmarnbelt offshore station in 2009 (upper chart) and 2010 (lower chart): migration intensity per day in ind./h. Scale of the y-axis is 1,000 compared to 5,000 at the onshore locations; days covered with observations are indicated in grey on the upper axis.

FEHMARNBELT BIRDS

During night-time in 2009, the offshore station in the Fehmarnbelt picked up some of the migration peaks quite well, even with higher short-time migration intensities (93 % passerines) than registered at the land stations (Figure 4.11, Figure 4.12). In 2010, such high peaks were not recorded offshore.

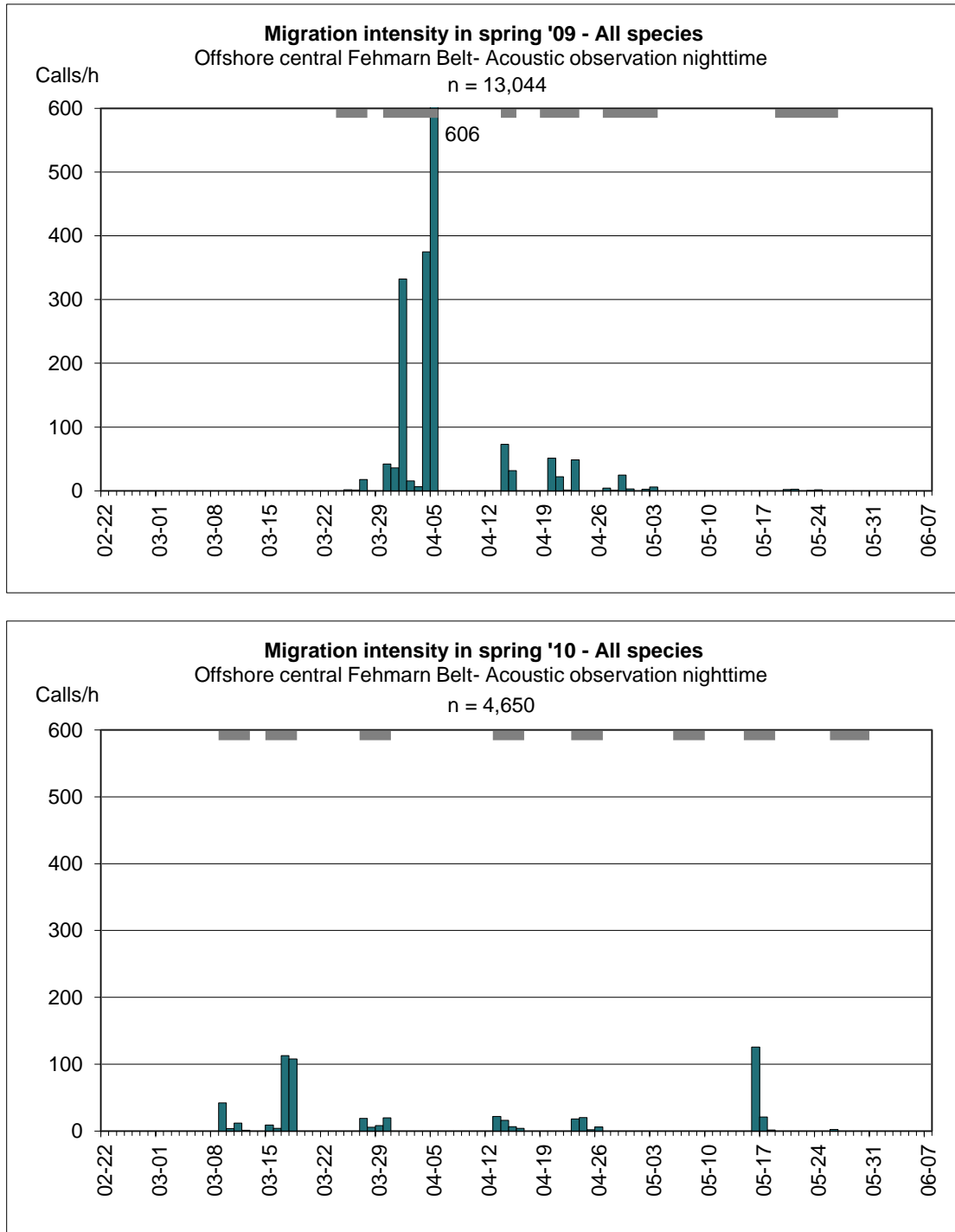

Figure 4.11 Spring 2009 (upper chart) and 2010 (lower chart): Night-time acoustic observations at Fehmarnbelt offshore station. Migration intensity per night in calls/h counted during night-time; nights covered with observations are indicated in grey on the upper axis.

FEHMARNBELT BIRDS

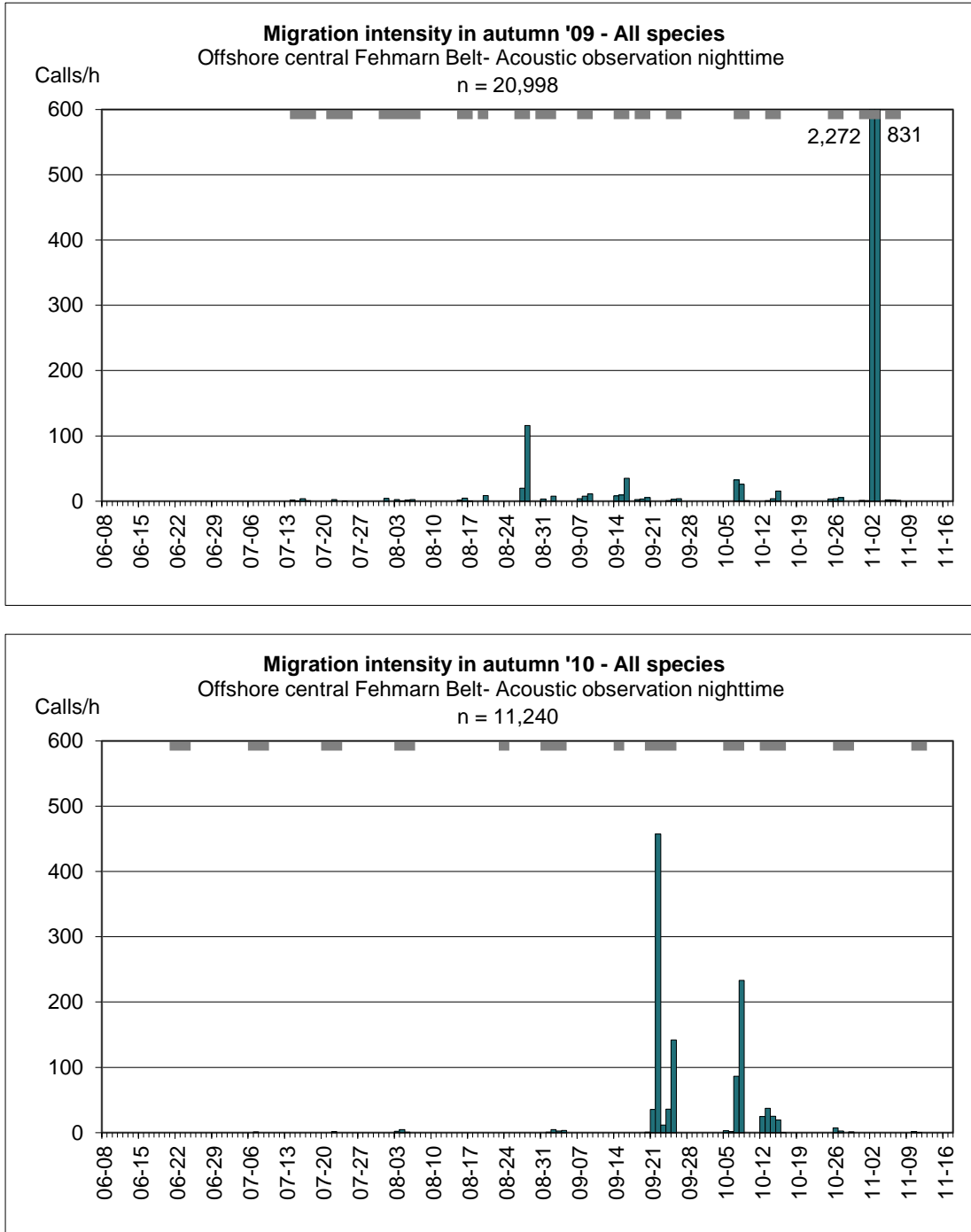

Figure 4.12 Autumn 2009 (upper chart) and 2010 (lower chart): Night-time acoustic observations at Fehmarnbelt offshore station. Migration intensity per night in calls/h counted during night-time; nights covered with observations are indicated in grey on the upper axis.

Hyllekrog offshore station

Diurnal migration intensities during autumn 2009 at the Hyllekrog station – as measured from the offshore ship – show a similar pattern to Rødbyhavn, with peaks at the beginning of October and medium intensities recorded until mid-November. However, intensities were lower overall compared to the Rødbyhavn station.

During night-time, calling intensities in general were low, but the recorded pattern was similar to the one observed at Rødbyhavn onshore.

Summary

Overall migration intensities differed between locations. Visual observations showed a very high intensity of waterbird migration in spring near Rødbyhavn along the Lolland coast and in autumn near Puttgarden close to the Fehmarn coast. Despite variations in effort and observation conditions, the observations from the offshore location in the central Fehmarnbelt showed considerably lower waterbird migration intensities overall, suggesting an intensity gradient across the Fehmarnbelt.

The passerine migration, as registered with visual observations, showed an almost opposite picture to the migration of waterbirds, i.e. high migration intensities during spring at Puttgarden and during autumn at Rødbyhavn in both baseline years. This illustrates the ubiquitous finding that passerines accumulate during migration at coastal locations before crossing large water bodies (Alerstam and Pettersson 1977, Bruderer and Liechti 1998, Erni et al., 2005). This effect is apparently more pronounced during autumn migration, both due to the overall higher numbers after the breeding season and due to the location of Rødbyhavn, which is a main leaving point for southward migration in eastern Denmark (Kahlert et al., 2007, Skov et al., 2008). Visible passerine migration intensities at the offshore locations in the central Fehmarnbelt were generally low during spring and autumn, even though during autumn patterns of high and low intensities could be observed. At the Hyllekrog offshore location in general low migration intensities occurred in 2009, however, with two pronounced passerine migration peaks, representing unidentified passerines and Chaffinches and Meadow Pipits. For night-time migration of passerines the pattern differs, as both at Puttgarden and at Rødby calling intensities were higher during autumn than during spring migration.

4.2.2 Migration phenologies as registered by vertical surveillance radar and pencil beam radar

The assistance of radar devices delivers results on migration intensities as well as altitude distributions in addition to visual and acoustic observations especially for times when visibility is low (night, fog etc.) and for distances where visual and acoustic observations - horizontally and vertically - do not suffice. Also, radar can record data 24 hours a day and thus deliver uninterrupted results for extended time periods.

Vertically turned surveillance radars have been operated at the three stations, and an additional radar of the same type was operated at the NW tip of Fehmarn in Westermarkelsdorf (Figure 3.1). In addition, the 'Superfledermaus' from the Swiss Ornithological Institute was placed at the Rødbyhavn field station during 2009 and at the Puttgarden field station during 2010. Used in fixed pencil beam mode it produced data on migration intensities per altitude category (chapter 4.5, Appendix B.1 to B.5). The vertically turned surveillance radars covered bird migration up to 1,500 m distance and altitude, the 'Superfledermaus' allowed bird detection up to 3,600 m.

The surveillance radars were operated continuously covering the entire study period. However, comparisons were only possible for the year 2010, as in 2009, radar data analyses was largely limited (see method chapter 3.2.4).

Comparisons between the locations and radar devices

A first step in the analyses of these data was to compare results of the same devices at different locations as well as to compare different devices at the same location. Both migration intensities and phenologies can be compared.

With regard to migration intensities, only relative migration intensities were used, since both the difference between the radar types as well as differences within one type due to unknown internal settings / characteristics would prohibit a direct numerical comparison. Migration intensities as measured by the surveillance radars were expressed as "mean number of signals per screenshot per night" (range 0-150 signals/screenshot), migration intensities recorded by the pencil beam radar are measured as "mean traffic rate", i.e. the number of signals along a 1 km transect / plane (range 0-12,000 signals/km/h). For the pencil beam, only the measurements covering all altitudes were used, at Puttgarden with the beam directed SE along the coast at 124° and thus parallel to the vertical surveillance radar.

With regard to migration phenologies, simple correlations between stations and devices are shown in Table 4.17. Here, R^2 mainly assesses the accordance of peaks and lows.

Since migration during daytime is markedly different from migration during night-time, comparisons were conducted for days and nights separately. Also, in order not to split up a "migration night" at midnight into two different events, each night was analysed as an entity and was assigned the date of the beginning of the night.

Figure 4.13 shows migration intensities as recorded with different individual radars of the same type (vertical surveillance), however, at different locations, showing the phenology over the year 2010. The absolute migration intensities measured by the surveillance radars at Puttgarden and Rødbyhavn are comparable in dimension. However, the radar at Westermarkelsdorf shows continuously higher migration intensities than Puttgarden. With regard to migration phenologies, peaks and lows are occurring at the same time in many cases, but exceptions apply (Figure 4.13).

FEHMARNBELT BIRDS

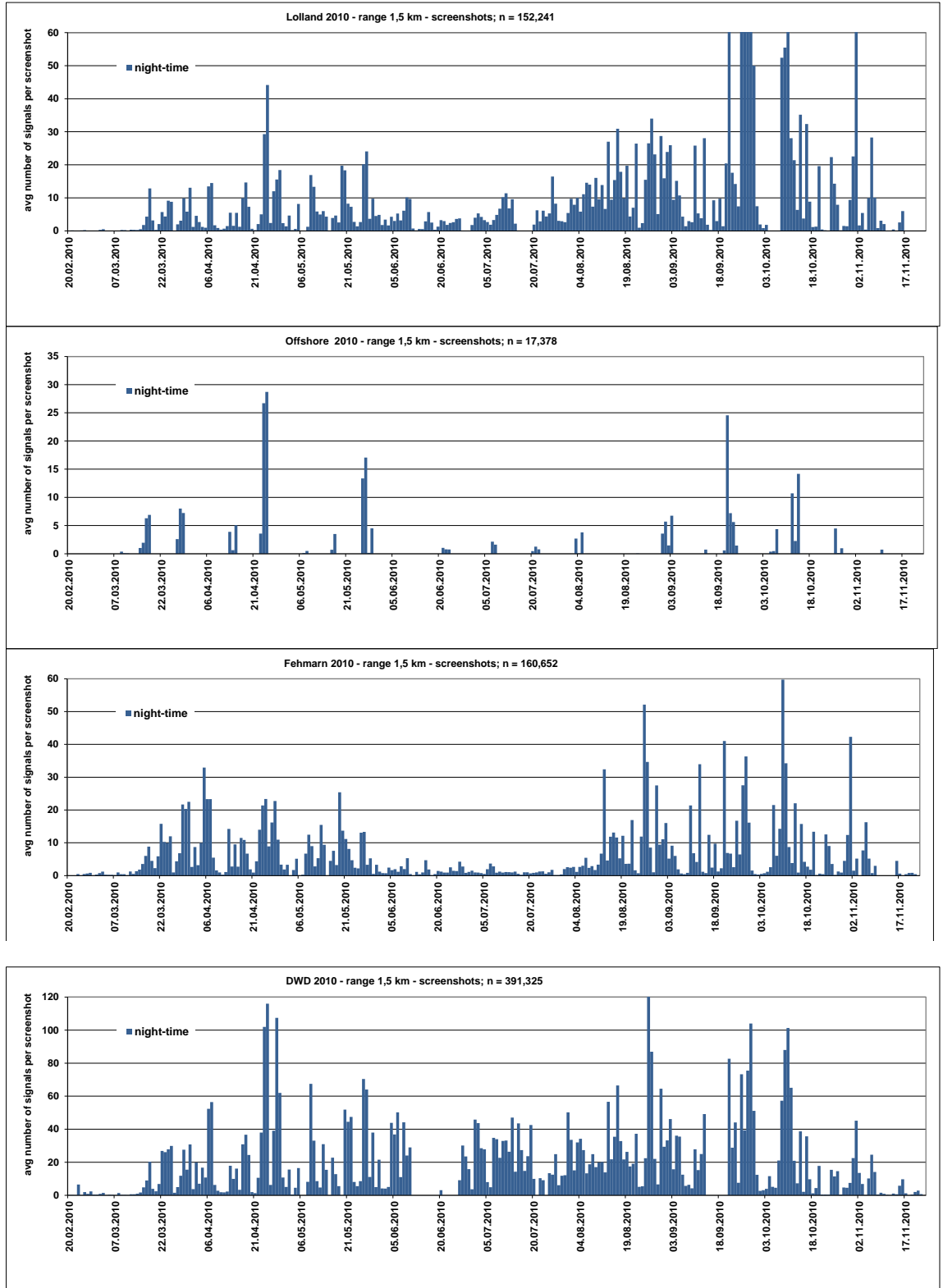

Figure 4.13 Night-time migration intensities as measured by surveillance radars at Lolland, offshore Fehmarnbelt, Fehmarn Puttgarden and Fehmarn Westermarckelsdorf (from top to bottom) in 2010. Coverage at the offshore station (top chart) limited to ship trips; inactive periods at other stations due to technical failure are too small to be pointed out.

FEHMARNBELT BIRDS

Figure 4.14 shows results from the fixed pencil beam at Puttgarden.

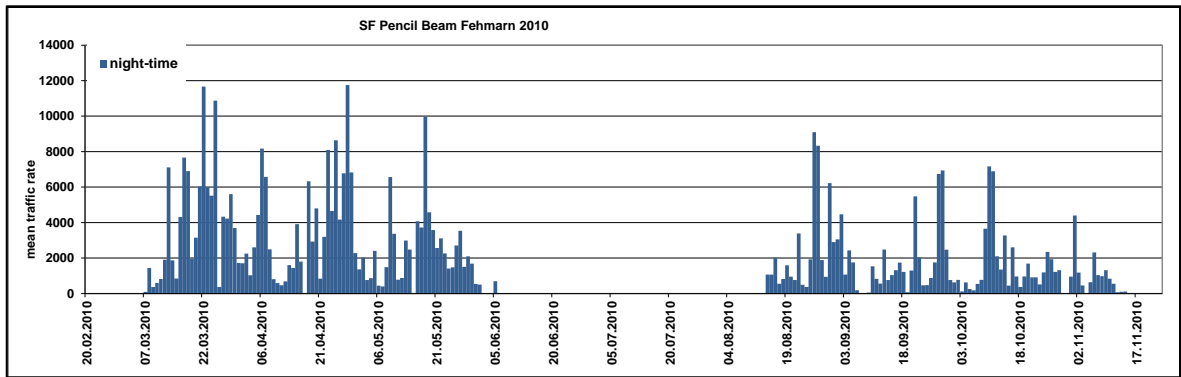

Figure 4.14 Night-time migration intensities as measured by fixed pencil beam radar at Fehmarn Puttgarden in 2010. Fixed pencil beam has been inactive June 17 to August 14.

Statistical comparison of the surveillance radar results from the stations Puttgarden, Rødbyhavn and Westermarkelsdorf (Fehmarn) reveals a reasonably good correlation, measured as R^2 , with regard mainly to the coincidence of peaks and lows in migration intensity during night-time (Table 4.17). It must be noted, that the Westermarkelsdorf radar showed consistently higher intensities than the Puttgarden station during day- and night-time. As no objective calibration procedure between different radar devices and / or surveillance radar devices of the same built is available, these quantitative differences cannot be interpreted.

Statistical comparison between the surveillance radar and the fixed pencil beam at Puttgarden in 2010 also shows a reasonable agreement between peaks and lows at night-time (Table 4.17, Figure 4.13 with Figure 4.14). However, the four nights with highest migration intensities according to the fixed pencil beam, all during spring 2010 on March 22 and 25, April 28 and May 18, are not matched by equally high intensities on the surveillance radar. On the other hand, most peaks detected by the surveillance radar, e.g. in autumn 2010, are peaks also detected by the fixed pencil beam radar. Explanations for differences between these two radar types could be: a) the fixed pencil beam has measured signals beyond the range of the surveillance radar; yet, except for March 25, three of the four peak nights in spring 2010 it applies, that most of the pencil beam signals had been registered below 1,500 m and thus could have been theoretically covered also by the surveillance radar. Also, if only compared to the lower 1,500 m, the correlation does not improve (data not shown); b) the sensitivities between the fixed pencil beam and the surveillance radar are different, such that they simply allow detection of different sized birds; c) sampling effort is different, as from the surveillance radar 12 screenshots per hour representing 6 evenly spaced minutes per hour are analysed, while the fixed pencil beam covers 2 x 4 minutes per hour, but not evenly spaced, thus stochastic effects may come in. As a conclusion, it is documented that both radar types are suited to detect bird migration events during night, however, with some differences. Some events seem to be better detected by the fixed pencil beam than by the surveillance radar.

FEHMARNBELT BIRDS

Table 4.17 Spearman correlations between the migration intensities as measured by different radars in 2010 at different locations. Given is the R^2 per possible meaningful combination; * indicates significant Spearman correlation.

		Puttgarden		Rødbyhavn		Offshore		Westermarkelsdorf		Pencil Beam Puttgarden	
		day	night	day	night	day	night	day	night	day	night
Rødbyhavn	day	0.397*									
	night		0.491*								
Offshore	day	0.709*		0.381*							
	night		0.641*		0.653*						
Westermarkelsdorf	day	0.210*		0.270*				0.112*			
	night		0.541*		0.476*				0.761*		
Pencil Beam Puttgarden	day	0.044*		0,006		0.010		0.027			
	night		0.355*		0.334*		0.335*		0.321*		
acoustic observations	night		0.218*		0.430*		0.120*		0.057*		0.005*

The correlations between daytime migration intensities from different surveillance radars are overall less strong than between night-time migration intensities. The main reason is that during daytime a large but variable amount of birds will migrate in flocks, while neither radar is able to correctly separate flocks from single flying birds. This inevitably leads to a high variation of the data and consequently to a lower correlation between them. Taking this into account, additional explanations for low correspondence of results may be a) overall lower migration intensities leading to higher relative variances; b) migration in low altitudes, also typical for daytime migration, but is generally incompletely picked up by these radar devices. The correlation of daytime data between the surveillance radars and the fixed pencil beam is even weaker, since the fixed pencil beam radar during daytime has only half the sampling interval per hour than during night-time, thus sampling a very low percentage of time and thus being more sensitive to short migration peaks or the occurrence of flocks.

A comparison between Puttgarden and Rødbyhavn shows, that migration intensities between those correlate quite well, as well as do the measured intensities between the land station Rødbyhavn and the offshore station.

Comparisons with the only other night-time data available, the acoustic data on calling intensities, are not as strong, however, all significant. This is expected, as calling intensities only apply for low-flying night-calling birds, while radar will cover all birds up to 1500 m in case of the surveillance radar and even higher for the fixed pencil beam radar.

It must be noted at this place, that correlations between surveillance and pencil beam radars with the long-range weather radar at Stevns, DK, all came out very low, which lead to the decision to not consider the weather radar for further analyses (chapter 3.6).

FEHMARNBELT BIRDS

Migration phenologies

Vertical surveillance radar data foremost deliver migration intensities for night-time when visual observations are not available. The following key questions regarding a fixed link across the Fehmarnbelt were identified:

- What are the migration phenologies at the different locations?
- Is there a concentration of bird migration in the area of the alignment?

For 2009 only the intensity measures yielded from the fixed pencil beam radar at Rødbyhavn could be used. These are displayed for spring (Figure 4.15) and autumn (Figure 4.16), showing the added results for day- and night-time, this way providing an impression of migration phenology, peaks of migration such as late May, early April during spring as well as medium intensities late August to mid September and a distinct peak around October 8-10. Low intensities after mid October are probably false due to a hardware failure of the Swiss radar and have not been used for further analyses (Appendix B.3).

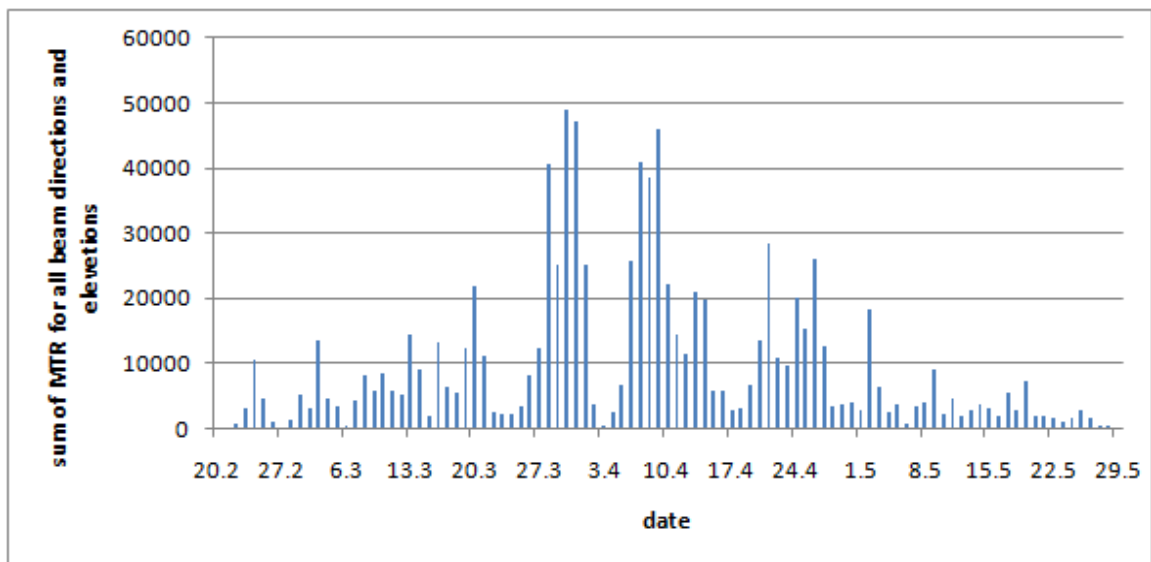

Figure 4.15 Seasonal dynamics of spring migration measured by fixed beam radar mode, daily sums of MTR of all elevations of the radar beam, all echoes, sea and land transects, spring 2009.

FEHMARNBELT BIRDS

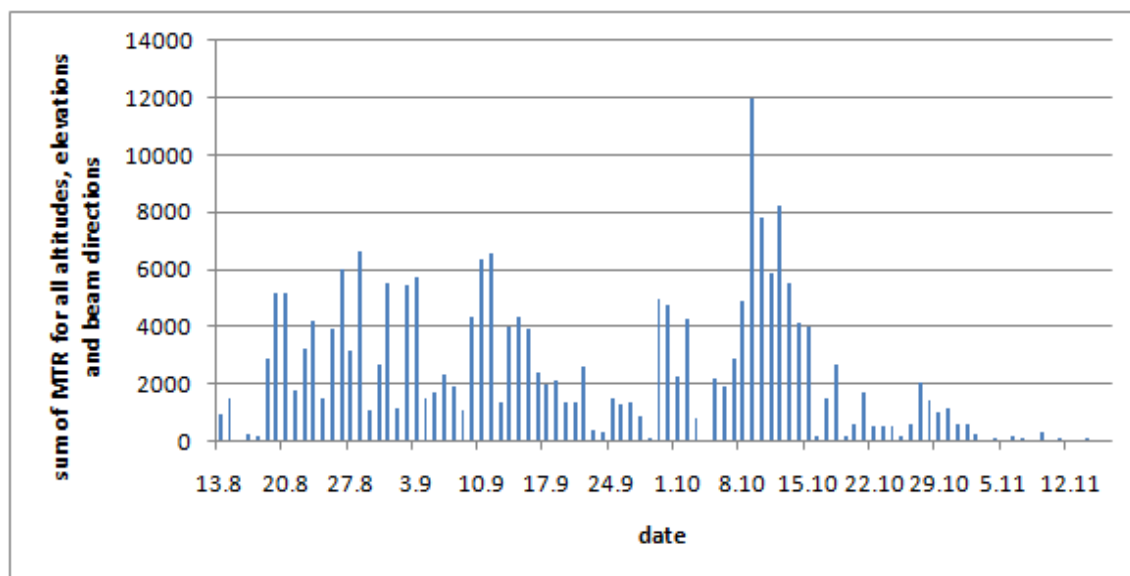

Figure 4.16 Seasonal dynamics of autumn migration measured by fixed beam radar mode, daily sums of MTR of all elevations of the radar beams and all altitudes, land and sea transect, autumn 2009.

For 2010, results from the surveillance radars have been used for the comparison, using relative migration intensities, i. e. is all migration intensities were scaled with the highest value represented by the number 100. Night-time results were compared.

During spring 2010, at the Puttgarden station high migration intensities were recorded from mid-March to mid-April, when the other stations showed lower values; this suggests that migration concentrated at Fehmarn, Puttgarden, while it was less concentrated at the other locations.

From April 23 to April 30 all stations showed high intensities. Both Lolland and Westermarkelsdorf had the highest spring 2010 peak on April 25. On May 26 and 27 all stations measured high intensities. However, in early June, low intensities were registered at Fehmarn with somewhat higher intensities during some days at Westermarkelsdorf and at Lolland, e.g. on June 9.

Regarding the results from autumn 2010 it is remarkable, that during the first 10 days of August the relative migration intensities during night-time were low at Puttgarden, while medium values were recorded at Westermarkelsdorf and Lolland. August 26 shows a peak at Fehmarn stations, with lower values at Lolland. However, from late August all major migration peaks at Puttgarden are matched by peaks at the other two stations, such as August 27, September 21, October 11 and November 1. A few outstanding peaks, e.g. on October 8/9 were only recorded at Lolland and Westermarkelsdorf with lower values at Puttgarden (see chapter 4.4.2 for further issues on migration altitudes).

In summary, a comparison of night-time migration peak events at all stations show that – with some exceptions - many peaks coincide at all stations, suggesting that migration occurs across the Fehmarnbelt instead of veering off from either departure location without reaching the other coast. However this statement may be somewhat premature as e.g. species information is missing.

FEHMARNBELT BIRDS

Therefore, conclusions from vertical radar data can only be considered as very general. However, as the reference station at the NW corner of Fehmarn also shows synchronous peaks with the other stations during night-time, a situation of broad-front migration is likely.

4.2.3 Summary and assessment of migration intensities in the Fehmarnbelt region

To assess the role of the Fehmarnbelt region in the regional migratory system of Scandinavia, migration traffic rate (MTR, birds* h^{-1} * km^{-1}) is the universal measure of intensity of migration which is calculated as number of birds passing through a virtual vertical plane of one kilometre in one hour. MTR can be calculated on the basis of any method used for quantitative estimation of migration intensity – visual observations, moon-watching, infrared camera observations, fixed beam radar. While MTRs can vary with the radar device used due to sensitivity and physical characteristics of the radar, they can be given for separate altitude bands. Results depend also on the direction at which MTRs are measured, which is preferably perpendicular to the expected migration direction. Also, MTR results will be sensitive to sampling frequency (e.g. in case of flocking species) and the period of time used for averaging (e.g. day or night-time, times including inclement weather, peak migration vs. low migration etc.). Due to these sources of variability comparison of MTRs between different projects has to be done with caution. However, MTR is up to today the only parameter in radar ornithology that allows to quantitatively compare migration at different locations.

A comparison of migration intensities (MTRs) at different areas across Europe and Africa, measured by the same device shows an increase of migration intensities and thus the accumulation of birds towards the south, especially in the areas of migration bottlenecks such as the straits across the Mediterranean Sea and passages in Alps.

MTRs are different for different altitude bands. In the lower 1500 m, MTRs in Israel reach 4,000 to 6,000 birds/km/h (tracking radar Superfledermaus). These figures might reach 6,000 or 9,000 birds in the first half of the night; in southern Germany at the lower 1,500 meters MTRs of about 1,700 birds/km/h have been measured and e.g. 3,400 birds/km/h at the northern border of the Alps.

Moon-watching data (covering the lower 1500m altitude band) provide somewhat lower figures, namely 1,000 for southern Germany and 2,500 for the northern border of the Alps; very high numbers recorded in top nights are in the order of 4,000-8,000 birds/km/h; in the bottleneck between the Alps and the Jura mountains near Geneva, Switzerland, a maximum of 15,000-20,000 birds/km/h was once recorded after a long period of bad weather.

In the western desert of Egypt, MTRs are around 1,500 birds/km/h during the best four night hours in late September and about 400 birds/km/h towards the end of August. MTRs in south-eastern Europe during autumn 2000 were in the range of 500 to 2,700 birds/km/h, mostly around 1,000 birds/km/h, thus, similar to those in Western Europe (cited after Bruderer 2001). Mean MTRs of nocturnal broad front migration in the Sahara reach some 100 birds/km/h at night in the desert and up to 400 birds/km/h in an oasis; in daytime the intensity of migration is much lower (Schmaljohann et al 2007).

In Falsterbo in 1998 intensity of nocturnal autumn migration was measured by infrared camera; mean MTR for all altitudes together was 1,319 birds/km/h (SD=1,701 birds/km/h) reaching its maximum of about 7000 birds/km/h per

FEHMARNBELT BIRDS

night, during 14 night MTR was higher than 2000 birds/km/hour; nights with rain were excluded from calculations (Zehnder and Karlsson 2001).

Migration intensities in Fehmarnbelt area are summarized in Table 4.18. In spring 2009 at the Lolland coast, diurnal MTRs reached 60 birds/h/km and nocturnal MTR 300 birds/h/km) with values regularly above 2,000 birds/km/h and peaks of 4,000 birds/km/h (Stark et al., 2010). During autumn 2009 MTRs reached a maximum of 1,200 birds/km/h for the second half of the night; averaged over the entire autumn season (13.8. – 16.11.2009), the mean seasonal MTR during night-time was around 93 birds/km/h, while during daytime it was 41 birds/km/h, thus overall lower compared to spring 2009. In spring 2010 at the Fehmarn coast, the MTR showed a peak of up to 3,100 birds/km/h, with averaged MTRs of 120 and 400 birds/km/h (Stark et al 2011). In 2010 autumn migration was up to 2,000 birds/km/hour, and also with the averaged MTRs more intensive compared to autumn 2009 at the Lolland coast.

Table 4.18 Migration intensities at Fehmarnbelt area measured by Superfledermaus in in fixed pencil beam mode as migration traffic rate MTR [birds/km/hour]. The beam was directed along the coast measuring migration towards land..

Location	Season	Part of day	Averaging time / altitude	Mean seasonal MTR	Maximum MTR during peak	Date of migration peak
Rødbyhavn	Spring 2009	day	19.02 – 29.05 /	60	600	31.03
		night	4000 m	300	4100	09.04
Rødbyhavn	Autumn 2009	day	13.08 – 30.10* /	41	400	20.08
		night	3000 m	106	1200	28.08
Puttgarden	Spring 2010	day	8.03 – 6.06 /	120	1200	10.05
		night	3275 m	400	3100	18.05
Puttgarden	Autumn 2010-	day	14.08 – 15.11 /	284	1000	28.10
		night	3275 m	374	2100	13.09

* Data only until Oct 2009 due to technical failure of the fixed pencil beam in November 2009.

Considering that in 2009 the Superfledermaus was placed at the Lolland coast, in 2010 at the Fehmarn coast, the high values in spring 2009 could both originate from high waterbird numbers and from high nocturnal migrants arriving at the coast, as confirmed by all other observations. Low numbers at the Lolland coast in autumn 2009 could indicate that Rødbyhavn is not a main leaving concentration for nocturnal migrants. In turn, the high numbers in spring 2010 at the Fehmarn coast could indicate that this is indeed a cumulation point also for nocturnal migration.

In comparison, MTRs measured in 2008 on the island of Rügen (120 km east of Fehmarnbelt) by fixed beam radar within an altitude band of 1400 m exceeded 2,000 birds/km/h during one night in August and during three nights in October with maximum values about 4,000 birds/km/hour (F. Liechti, written comm.). MTRs obtained by BIRD SCAN (based on surveillance radar) at the same place and time provide higher values (Neumann et al., 2009). Comparison of MTRs during nocturnal migration at Fehmarnbelt, Falsterbo and Rügen leads to the conclusion that MTRs at Fehmarnbelt during night-time are in general lower than for example at Falsterbo or Rügen. This suggests that in autumn the main night-time passage of nocturnal migrants happens broad-front and also east of Fehmarnbelt. However, during daytime the autumn migration in the Fehmarnbelt region produces high MTRs, most likely including the very important numbers of seabirds, birds of prey and also passerines.

FEHMARNBELT BIRDS

As these are the only MTRs measured with the Superfledermaus in the Baltic region, no further comparisons between locations are possible.

To assess the migration intensity at the Fehmarnbelt region in comparison to e.g. the island of Rügen or Falsterbo, a look at nocturnal migration across Europe is useful. The Strait of Gibraltar is in many aspects similar to the Fehmarnbelt with a comparable width (about 15 km) and large water bodies on each side, and bird migration across Gibraltar is studied in many details at large and medium scale level. The general appearance of nocturnal autumn migration as seen by co-ordinated moon-watching over the European mainland confirms the idea of large-scale broad-front migration (Trösch et al., 2005). However, the modification added to pure broad-front migration is given by the fact that the main NE-SW stream over central and western Europe is deviated westward along the Alps, southward along the Atlantic and westward along the Mediterranean Sea (Bruderer 2001). These features of guided broad-front migration are emphasized for the western Mediterranean Sea and Strait of Gibraltar at various levels, which reveal that nocturnal migration is often guided by coastlines (Bruderer 2001). Along the Atlantic coast of southern France and Portugal, directions are more southerly in accordance with the general course of the coast. An infrared transect along the European coast of the western Mediterranean (from Toulon in south-eastern France down to Tarifa in south-western Spain) shows temporal shifts from off-shore flights towards coasting flights at most points where the coast deviates considerably from the preferred migratory direction (Fortin et al., 1999).

In case of the area of southern Scandinavia in autumn we have a large concentration of birds at Falsterbo which is the most southern tip of Scandinavia. If we assume that nocturnal migrants in this area have the same tendency to follow the coastline as it was found for the area of south-west Europe and Gibraltar, nocturnal migration intensities in autumn should be much higher at Falsterbo and the island of Rügen than at Fehmarnbelt, which is supported by our analyses.

4.3 Flight directions and flight paths

Knowledge about flight directions is essential when assessing the birds' main migration routes. Wind direction, wind speed and also distance to land will have a considerable influence on local distributions of flight directions; consequently, flight directions and altitudes may differ from season to season and from day to day (e.g. Åkesson and Hedenström 2000, Erni et al., 2002). At the same time, the overall flight directions sampled for the migration seasons provided a good impression of bird behaviour in the Fehmarnbelt region at the different observation spots.

At Fehmarnbelt, NW-SE orientated flight directions are mainly coast-parallel (coasting) in the Fehmarnbelt, whereas N/NE in spring and S/SW in autumn indicate that birds cross over the Fehmarnbelt (crossing) using shortest routes as possible.

The following chapter provides results concerning flight directions with data from the visual observations (4.3.1), tracks of identified species of the horizontal radar real-time tracking (4.3.2) as well as tracks of unidentified birds from the horizontal surveillance radar screenshots (4.3.3).

4.3.1 Flight directions and flight paths as registered by visual observations

Puttgarden onshore station

Overall flight directions at Puttgarden showed a scattered distribution during spring 2009 with some tendency for NW, W and E directions. These NW and W tendencies were more pronounced in the spring 2010 data, but here additionally SE directions were present as well (Figure 4.17). During autumn flight directions were strictly bimodal in both years with NW and SW directions (Figure 4.17).

Flight directions in spring '09 [%] - All species
Puttgarden - Land sector and sea transect
n = 174,014

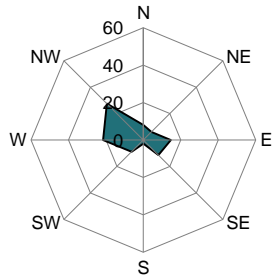

Flight directions in autumn '09 [%] - All species
Puttgarden - Land sector and sea transect
n = 364,088

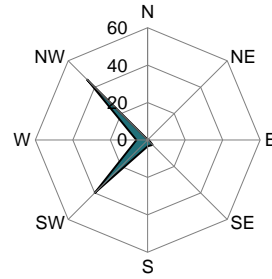

Flight directions in spring '10 [%] - All species
Puttgarden - Land sector and sea transect
n = 144,462

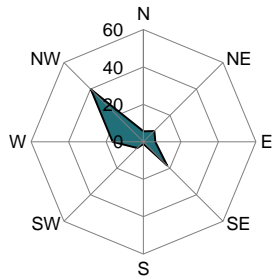

Flight directions in autumn '10 [%] - All species
Puttgarden - Land sector and sea transect
n = 458,144

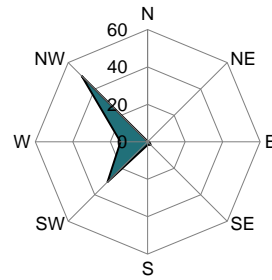

Figure 4.17 Daytime visual observations at Puttgarden onshore station: flight directions of all species in spring and autumn 2009 (top) and 2010 (bottom); results given in %.

FEHMARNBELT BIRDS

Separating these results into waterbirds and other species, waterbirds exhibit flight directions along the Fehmarnbelt in both directions in spring 2009 and even more pronounced in spring 2010 (Figure 4.18). During autumn waterbirds strictly flew NW. The other species followed westerly directions during both years' spring and strictly SW directions during autumn seasons of the two baseline years (Figure 4.18).

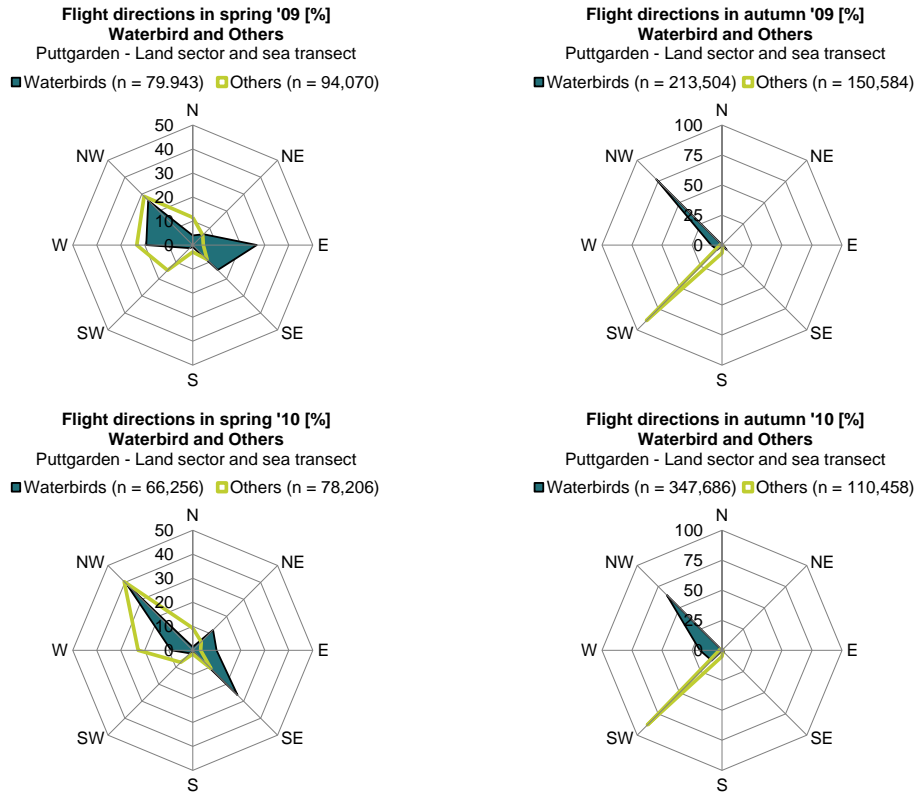

Figure 4.18 Daytime visual observations at Puttgarden onshore station: flight directions of all waterbirds (green shaded area) separated analysed from all other species (bold lime line) in spring and autumn 2009 (top) and 2010 (bottom); results given in %, different scales for spring and autumn.

FEHMARNBELT BIRDS

The westerly directions in spring were mainly related to passerines detected while flying along the coast and pigeons at higher altitudes also flying in westerly directions (Figure 4.19). The south-westerly directions in autumn were related to pigeons and passerines as well, in addition to birds of prey, all flying strictly in this direction (Figure 4.19, Figure 4.20).

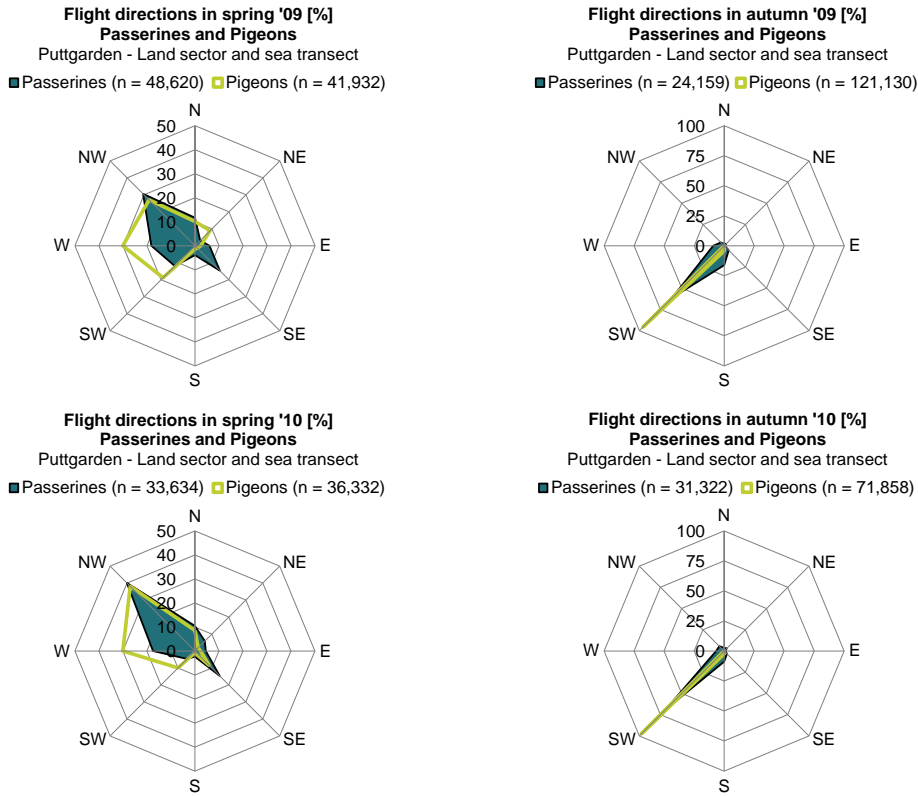

Figure 4.19 Daytime visual observations at Puttgarden onshore station: flight directions of passerines (green shaded area) and pigeons (bold lime line) in spring and autumn 2009 (top) and 2010 (bottom); results given in %, different scales for spring and autumn.

FEHMARNBELT BIRDS

As examples of separate groups, the geese and the birds of prey followed northward and north-eastward directions with some variability during spring (Figure 4.20). During autumn 2009 geese preferred NW, W and SW directions, while during autumn 2010 W and SW directions dominated, whereas birds of prey showed a strong SW preference in both baseline years (Figure 4.20).

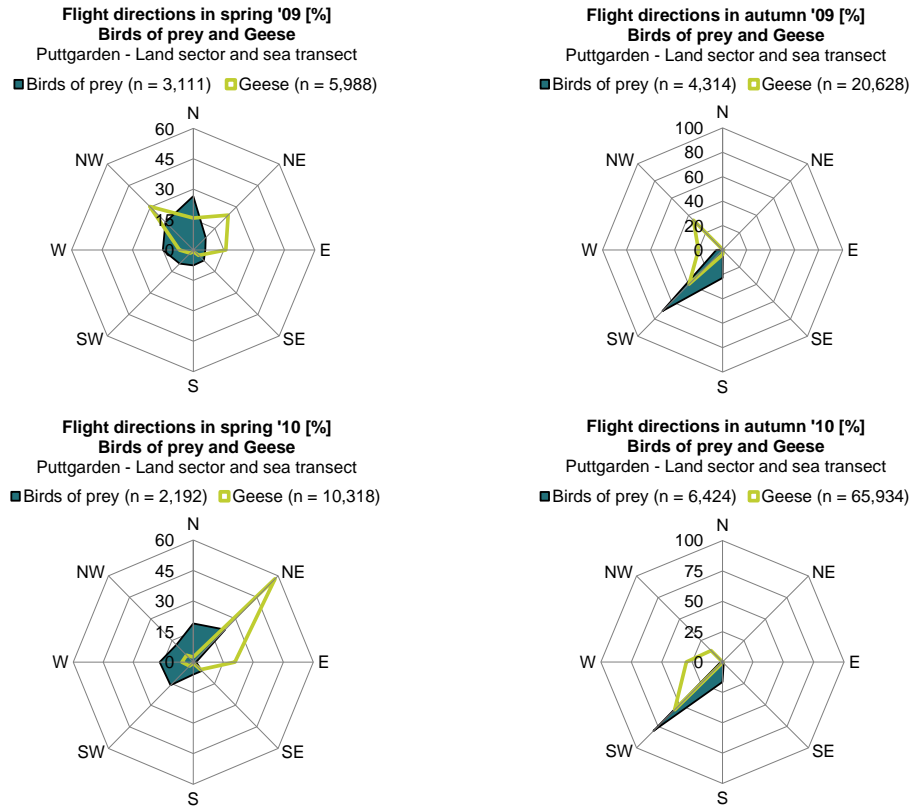

Figure 4.20 Daytime visual observations at Puttgarden onshore station: flight directions of birds of prey (green shaded area) and geese (bold lime line) in spring and autumn 2009 (top) and 2010 (bottom); results given in %, different scales for spring and autumn.

FEHMARNBELT BIRDS

Rødbyhavn onshore station

The overall spring distribution of flight directions at the Rødbyhavn station was clearly dominated by the large numbers of waterbirds registered, all flying in the SE direction (Figure 4.21). During autumn 2009, the distribution is bimodal, whereas during autumn 2010 additionally SE directions were recorded.

Flight directions in spring '09 [%] - All species
Rødbyhavn - Land sector and sea transect
n = 483,631

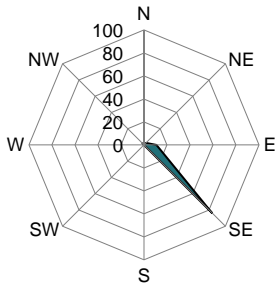

Flight directions in autumn '09 [%] - All species
Rødbyhavn - Land sector and sea transect
n = 666,629

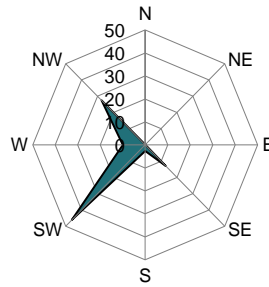

Flight directions in spring '10 [%] - All species
Rødbyhavn - Land sector and sea transect
n = 480,810

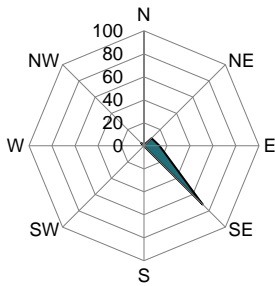

Flight directions in autumn '10 [%] - All species
Rødbyhavn - Land sector and sea transect
n = 972,872

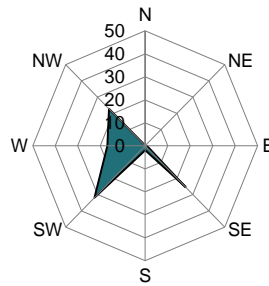

Figure 4.21 Daytime visual observations at Rødbyhavn onshore station: flight directions of all birds in spring and autumn 2009 (top) and 2010 (bottom); results given in %, different scales for spring and autumn.

FEHMARNBELT BIRDS

When separating results for different species groups, species other than waterbirds were observed flying towards NE (Figure 4.22). During autumn the other (non-waterbird) birds were recorded flying in SW and SE directions, while the waterbirds preferred W and NW directions along the coast (Figure 4.22).

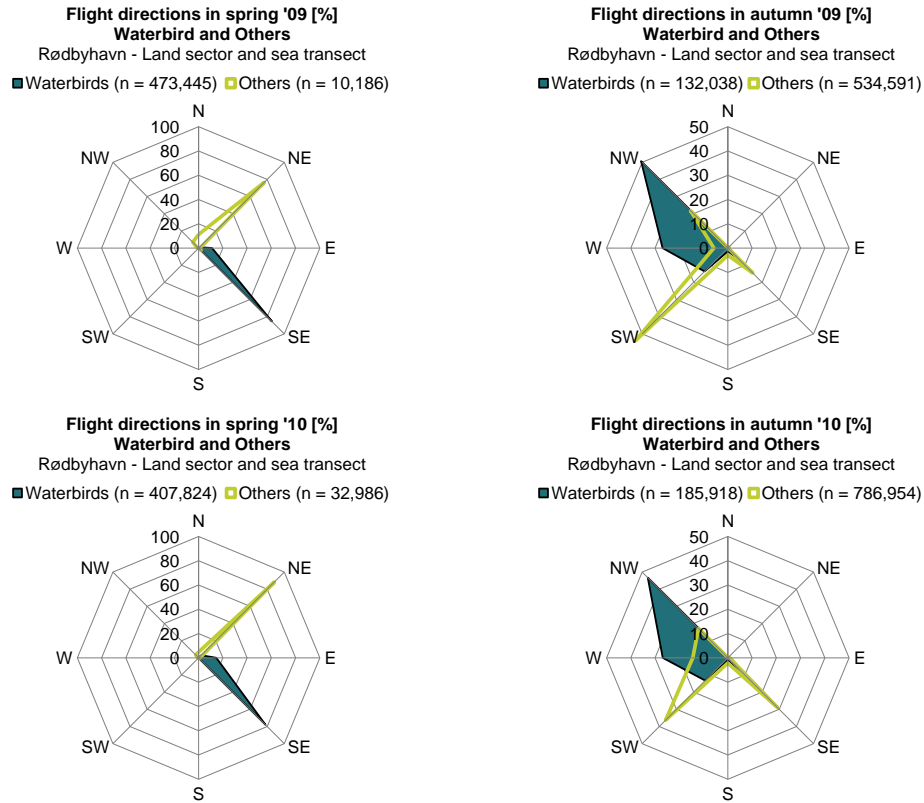

Figure 4.22 Daytime visual observations at Rødbyhavn onshore station: flight directions of all waterbirds (green shaded area) compared to all other species (bold lime line) in spring and autumn 2009 (top) and 2010 (bottom); results given in %, different scales for spring and autumn.

FEHMARNBELT BIRDS

Regarding passerines and pigeons, these species groups seemed to prefer the same migration directions in spring, however, using different flight altitudes with the pigeons frequently above 200 m (see below). During autumn pigeons preferred a SW migration direction, whereas passerines used both NW and SE directions (Figure 4.23).

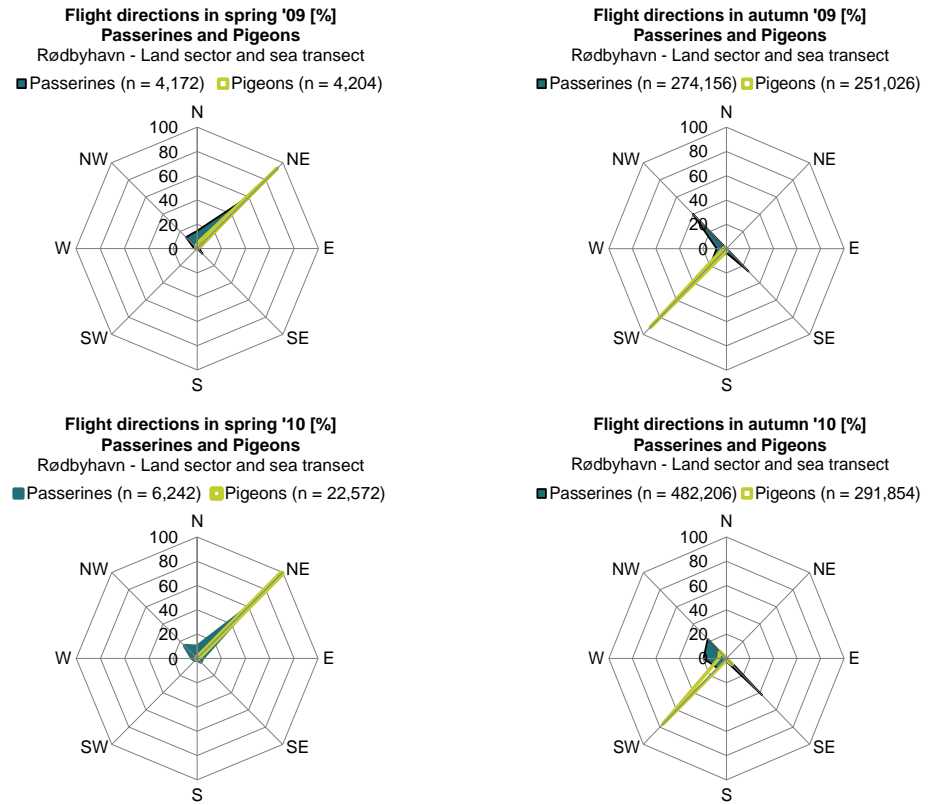

Figure 4.23 Daytime visual observations at Rødbyhavn onshore station: flight directions of passerines (green shaded area) and pigeons (bold lime line) in spring and autumn 2009 (top) and 2010 (bottom); results given in %.

FEHMARNBELT BIRDS

Recorded flight directions indicate geese preferring easterly directions during spring, i.e. partly flying over water, partly over land whereas during autumn they seemed to be crossing the Fehmarnbelt with flight directions towards W and SW (Figure 4.24). Birds of prey show clear migration directions indicating them crossing the Fehmarnbelt during both seasons (Figure 4.24).

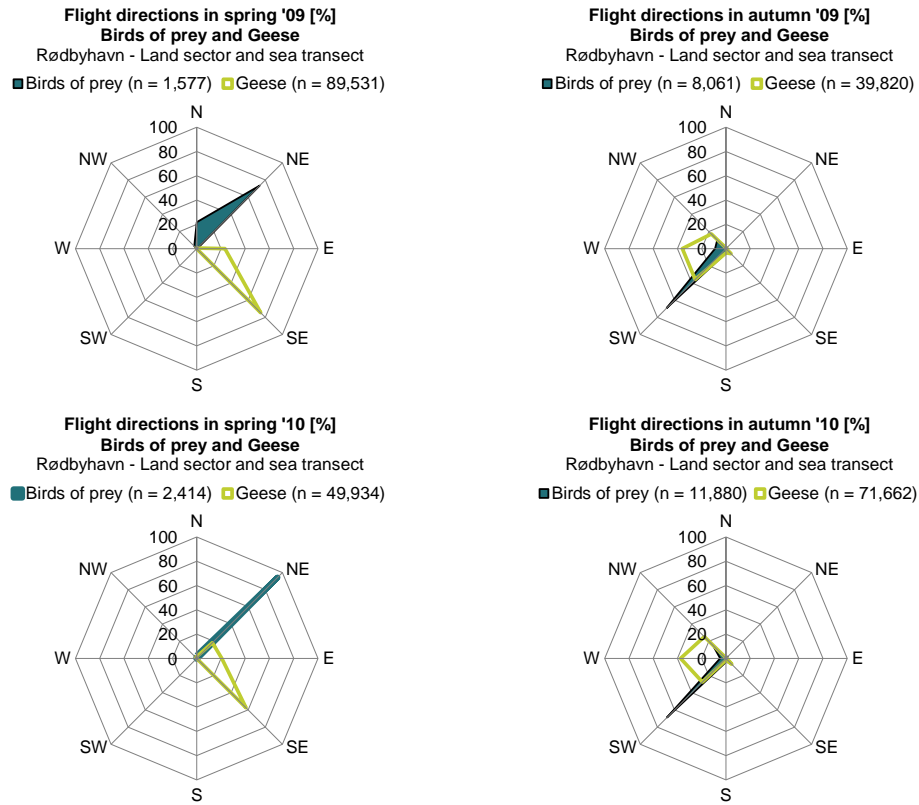

Figure 4.24 Daytime visual observations at Rødbyhavn onshore station: flight directions of birds of prey (green shaded area) and geese (bold lime line) in spring and autumn 2009 (top) and 2010 (bottom); results given in %.

FEHMARNBELT BIRDS

Fehmarnbelt offshore station

The observed flight directions in the central Fehmarnbelt showed a more scattered distribution compared to the observations at the onshore locations (Figure 4.25). In 2010 directions were more distinct with mainly easterly directions in spring and SW – W directions in autumn (Figure 4.25).

Flight directions in spring '09 [%] - All species
Offshore central Fehmarn Belt -
Visual observations daytime
n = 28,580

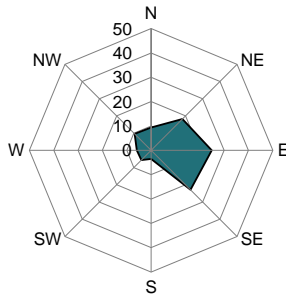

Flight directions in autumn '09 [%] - All species
Offshore central Fehmarn Belt -
Visual observations daytime
n = 80,674

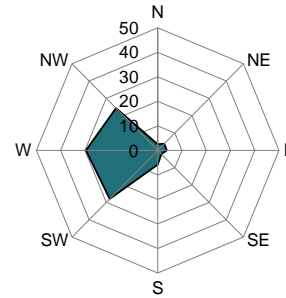

Flight directions in spring '10 [%] - All species
Offshore central Fehmarn Belt -
Visual observations daytime
n = 43,824

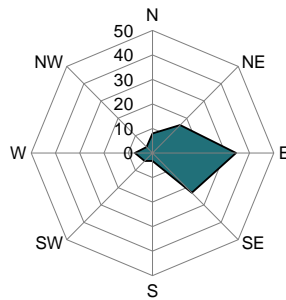

Flight directions in autumn '10 [%] - All species
Offshore central Fehmarn Belt -
Visual observations daytime
n = 66,658

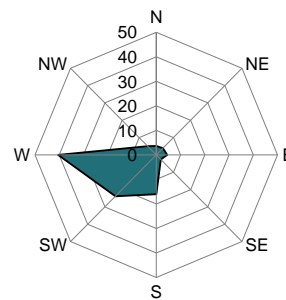

Figure 4.25 Daytime visual observations at Fehmarnbelt offshore: flight directions of "all birds" in spring and autumn 2009 (top) and 2010 (bottom); results given in %.

FEHMARNBELT BIRDS

When separated into waterbirds and others, the waterbird flight directions showed a tendency to follow the Fehmarnbelt. However, with a weaker tendency as observed at the land stations at Fehmarn and Lolland (Figure 4.26). An explanation may be that due to the lower migration intensities offshore in the Fehmarnbelt the waterbird movements are to a higher degree influenced by local movements of gulls and other waterbird species. During autumn 2010 waterbirds even show a strong tendency going W. Other (non-waterbird) birds showed in both years (however in low numbers) a NE migration orientation during spring, and S to SW orientations during autumn (Figure 4.26).

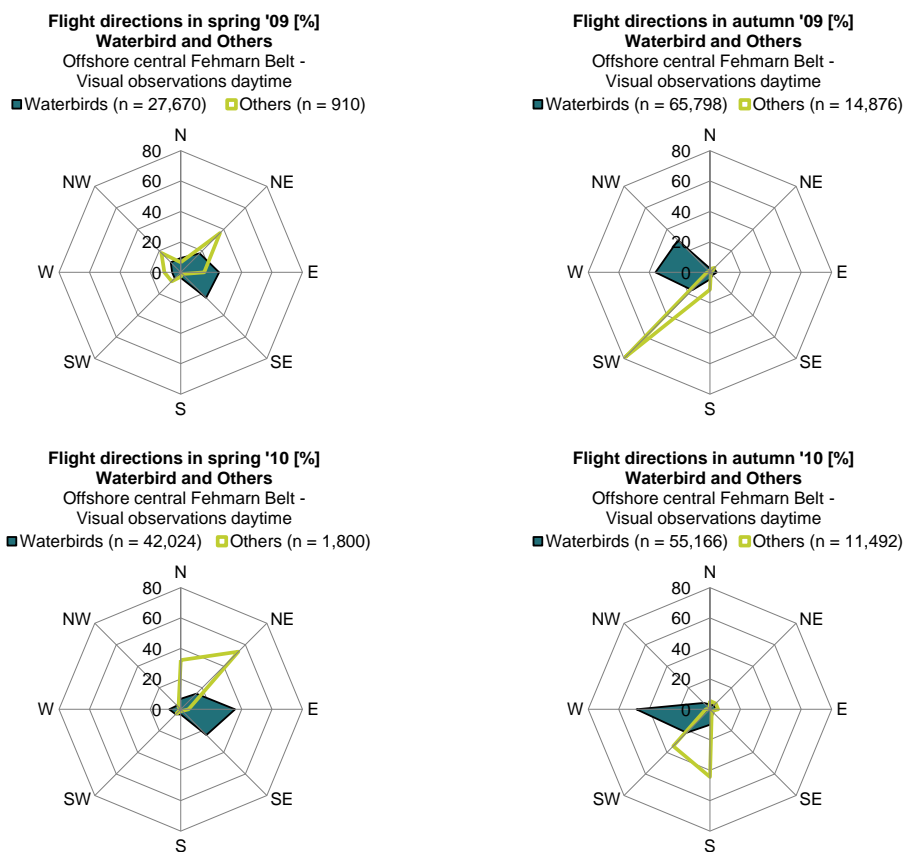

Figure 4.26 Daytime visual observations at Fehmarnbelt offshore of all waterbirds (green shaded area) and others (bold lime line) in spring and autumn 2009 (top) and 2010 (bottom); results given in %.

FEHMARNBELT BIRDS

Passerine and pigeon numbers during spring were low and the distribution of flight directions was either bimodal with a northward tendency in passerines in 2009 or N to NE in 2010, or E to NE for pigeons, however, with no data for pigeons in 2010 (Figure 4.27). During autumn, higher numbers showed mainly S and SW flight directions.

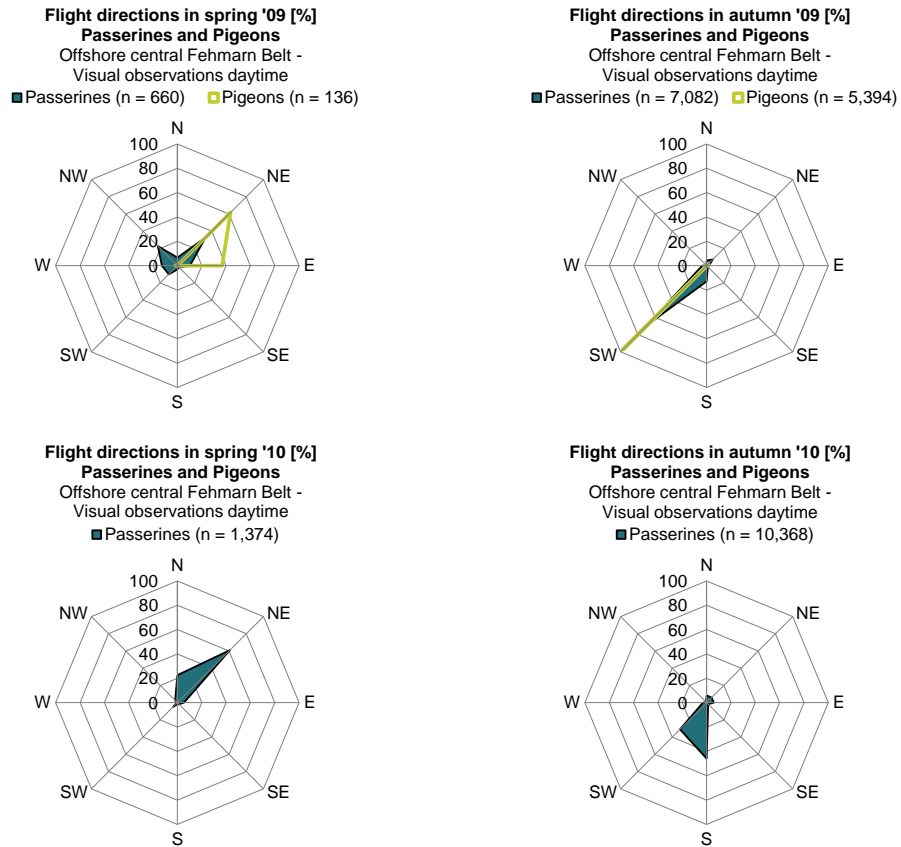

Figure 4.27 Daytime visual observations at Fehmarnbelt offshore of passerines (green shaded area) and pigeons (bold lime line; no data for 2010) in spring and autumn 2009 (top) and 2010 (bottom); results given in %.

FEHMARNBELT BIRDS

Flight directions of geese during spring 2009 were mainly towards SE directions, coinciding with the Rødbyhavn data but different from Puttgarden results. In 2010 geese preferred easterly directions. During autumn geese were observed mainly flying towards north-western and southern directions. Birds of prey were quite rare during spring, but the ones observed flew towards northern directions. During autumn for birds of prey SW flight direction dominated (Figure 4.28).

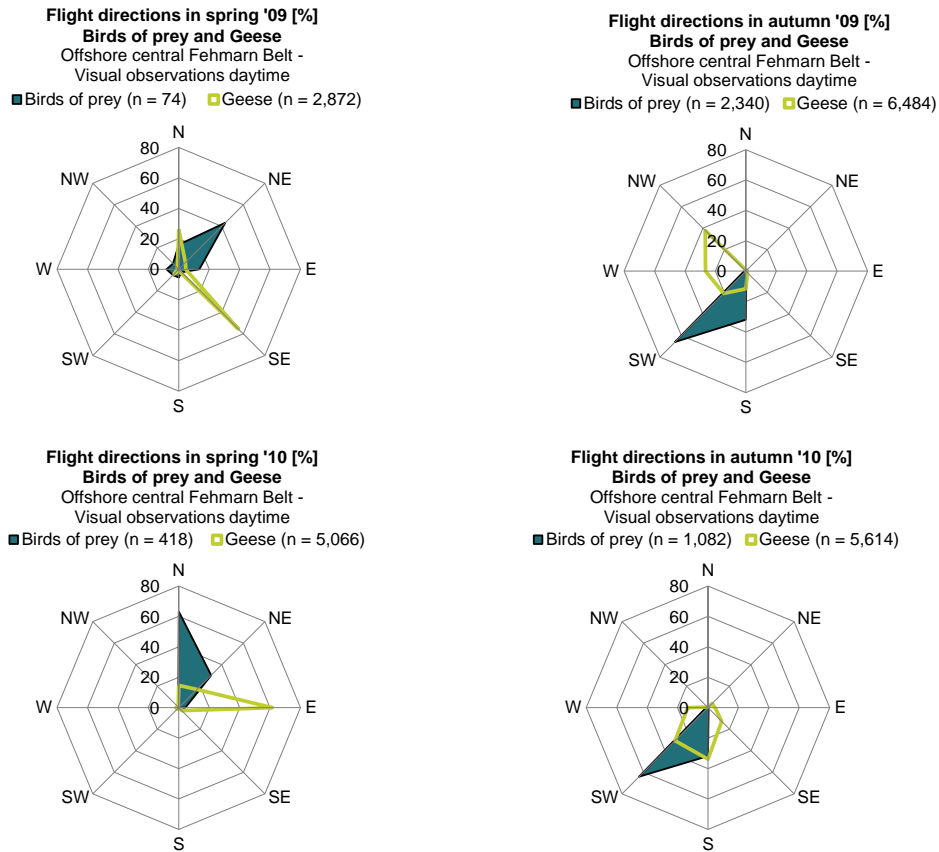

Figure 4.28 Daytime visual observations at Puttgarden onshore station: flight directions of birds of prey (green shaded area) and geese (bold lime line) in spring and autumn 2009 (top) and 2010 (bottom); results given in %, different scales for spring and autumn.

FEHMARNBELT BIRDS

Hyllekrog offshore station

Flight directions at the Hyllekrog offshore station coincide well with the Fehmarnbelt offshore locations (see below). However, distributions are less distinct (Figure 4.29). Yet, generally, waterbirds such as geese were observed flying along the coast, whereas flight directions of passerines and pigeons indicate these species crossing the Fehmarnbelt, with a southern component for the pigeons. Birds of prey flew mainly towards S and SW directions (Figure 4.29).

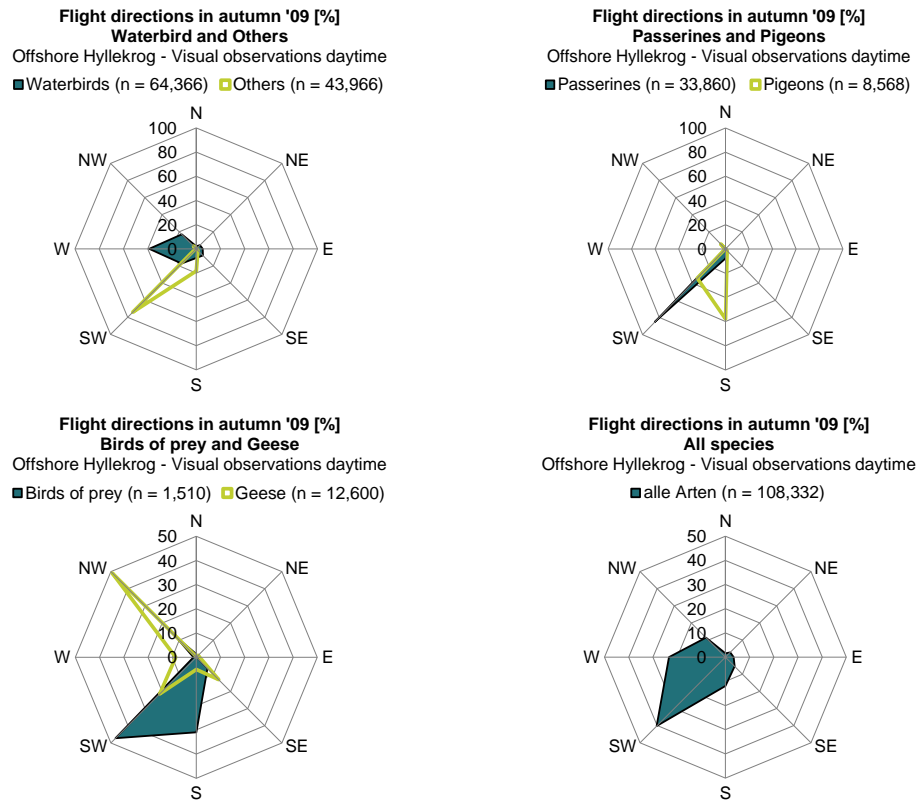

Figure 4.29 Daytime visual observations at Hyllekrog offshore during autumn 2009 of all birds (top left), all waterbirds and others (top right), passerines and pigeons (bottom left) and birds of prey and geese (bottom right); results given in %, different scales.

Summary

Overall flight directions as registered by visual observations, not separated by species groups, showed bimodal distributions, since landbirds typically flew NE / SW to cross the Fehmarnbelt while waterbirds flew SE / NW along the Fehmarnbelt. Thus, the overall patterns of flight directions followed the expected trends of spring and autumn migration in the western Baltic with little indication of e.g. return movements induced by bad weather or other incidents.

Almost all waterbirds showed flight directions more or less parallel to the Fehmarnbelt. During spring the majority of them moved in easterly directions, with a dominance of SE / E at both Rødbyhavn and the Fehmarnbelt offshore location, while at Puttgarden this dominance was not as pronounced. Some proportions of waterbirds moved NW and this fraction may represent species and individuals making short-distance movements. During autumn waterbirds were recorded mainly flying towards NW and W.

FEHMARNBELT BIRDS

The vast majority of the birds over the Fehmarnbelt during migration ought to be landbirds, as population numbers of these species including all the passerine species clearly outnumber the waterbirds. Landbirds head NE during spring and SW during autumn, thus crossing the Fehmarnbelt. Depending on the wind direction and strength they choose different departure points along the coastlines, which both minimise the risk of wind drift over sea and reduce the distance to the nearest land (e.g. Alerstam and Pettersson 1977, Bruderer and Liechti 1998).

Landbirds' flight directions were more variable than those of waterbirds. During spring landbirds at Puttgarden moved in NW, W and SW directions. Passerines have been observed following the coast at Puttgarden from SE to NW, most likely seeking a place to leave land to cross the Belt. This may override the suggested NE leaving direction. At Rødbyhavn they strongly preferred the NE direction during spring, suggesting that birds arrive from offshore and continue their flight towards NE, as this is the general migration direction. Birds of prey at Puttgarden mainly fly in N direction with some tendency for NW, W and NE directions. At Rødbyhavn they were observed to move strictly NE. During autumn, their flight directions at all stations were rather regular towards SW.

4.3.2 Flight directions - Horizontal surveillance radar real-time tracking

As the range of the visual observations is constrained, the accuracy of the recording of flight directions from visual observations is moderate. Real-time tracking provides exact flight directions and paths, also beyond the range of visual observations, once a bird or flock has been identified. Making use of all three observation stations, for some migration events, birds could be "followed" almost all the way across the Fehmarnbelt.

Thus, further analyses were undertaken on the basis of the data collected by the horizontal surveillance radars at the three stations. In the present chapter, migration directions and flight tracks of birds based on the real-time tracking data (see methods in chapter 3.4.3) are evaluated.

The evaluation distinguishes between four main types of migration patterns (see chapter 1):

- 1) Waterbirds preferentially migrating over water;
- 2) Waterbirds less reliant on migrating over water;
- 3) Landbirds migrating during daytime;
- 4) Landbirds migrating over a broad-front during night-time.

It is expected that type 1 and to a lesser extent also type 2 species are migrating at sea and parallel to the coastline, while type 3 species should cross the Fehmarnbelt more or less on the shortest distance between Rødbyhavn and Puttgarden. Type 4 species are expected to follow in general the same flight direction as type 3 species, but do not concentrate on the shortest link between the islands. In the present chapter the flight direction of species classified to either type 1 or type 3 are analysed.

Only species or species groups with more than 30 tracks per season available were analysed. First, the mean migration directions for the spring and autumn season for species groups and individual species were calculated. The

FEHMARNBELT BIRDS

significance of this mean direction was tested by the Rayleigh test with a significance level of $p < 0.05$ (Table 4.19). For the species where a statistically significant migration direction was found, it was further tested whether this species or species group followed the expected migration direction according to the species type 1 or 3, respectively. By definition, a migration route parallel to the Fehmarnbelt ("coasting") is expected to go towards the SE in spring (130°) and the NW in autumn (310°), while "crossing" the Fehmarnbelt along the "Fugleflugtslinien" or "Vogelfluglinie" would go towards NE in spring (25°) and towards SW in autumn (205°). Results were assessed using the V-test with a significance level of $p < 0.001$ (Table 4.19). The sample sizes of tracked species' directions were not sufficiently high to allow for computation of the test for all tracked species, however results can be provided for a range of species and species groups belonging to both investigated types.

Type 1 species – spring

On northbound migration, most species are expected to fly towards NE to reach the northern Baltic or to continue to the White Sea. However, when prone to migrate over water, the migration direction in Fehmarnbelt will be coast-parallel, thus 130° . During spring near Fehmarn, only Common Scoter and Common Eider showed a significant mean flight direction (Figure 4.30, Figure 4.31) as well as the group of the dabbling ducks (Table 4.19). However, most of these birds flew NW (312° to 316°). Taking into account that migration intensity of these species at Fehmarn is very low in spring, this reflects probably short distance movements during daytime as movements between main feeding grounds east and west of Fehmarn. Most other type 1 species / species groups showed diverse flight directions at the Fehmarn coast. Offshore in the central Fehmarnbelt, divers, seaducks and gulls as well as Common Scoter followed a significant mean direction. While those directions were mainly E between 77° and 99° they still were tested significant of flying coast-parallel at 130° . At the Lolland coast, where high waterbird numbers migrated during spring, most species except gulls, swans and Great Cormorant showed a significant mean migration direction, and in particular *Gavia* divers, *Branta* geese, dabbling ducks, seaducks, and waders as groups as well as Brent Goose and Common Eider followed the expected direction parallel to the coast.

Barnacle Goose is an interesting example, as it belongs to those species, flying long distances independent of coastlines or crossing distances. At Puttgarden, it was found to be directed towards NE (61°), while on Lolland it was observed flying towards E (108°) (see also chapter 5.3.2).

Type 1 species – autumn

While overall direction of autumn migration was observed bound to south-western directions, Lolland and Fehmarn coasts stretched migration towards a more northern direction. It was therefore expected that the coast-parallel migration would go towards 310° (Figure 4.30, Figure 4.31, Table 4.19). Common Eider, during autumn with lower numbers occurring at the Lolland coast, still showed significant directions parallel to the Lolland coast. This applies also for high numbers of Common Eiders registered at that time at the Fehmarn coast, as well as for Great Cormorant, Barnacle Goose, Mallard, Eurasian Wigeon, Black-headed Gull, Herring Gull, and Great Black-backed Gull. Offshore in the central Fehmarnbelt no bird species or group except Common Eider were tested to migrate in the expected direction with any significance.

FEHMARNBELT BIRDS

Again, Barnacle Goose at the Fehmarn coast showed a significant migration direction during autumn of 244° with significant results for both the coasting and the crossing direction.

FEHMARNBELT BIRDS

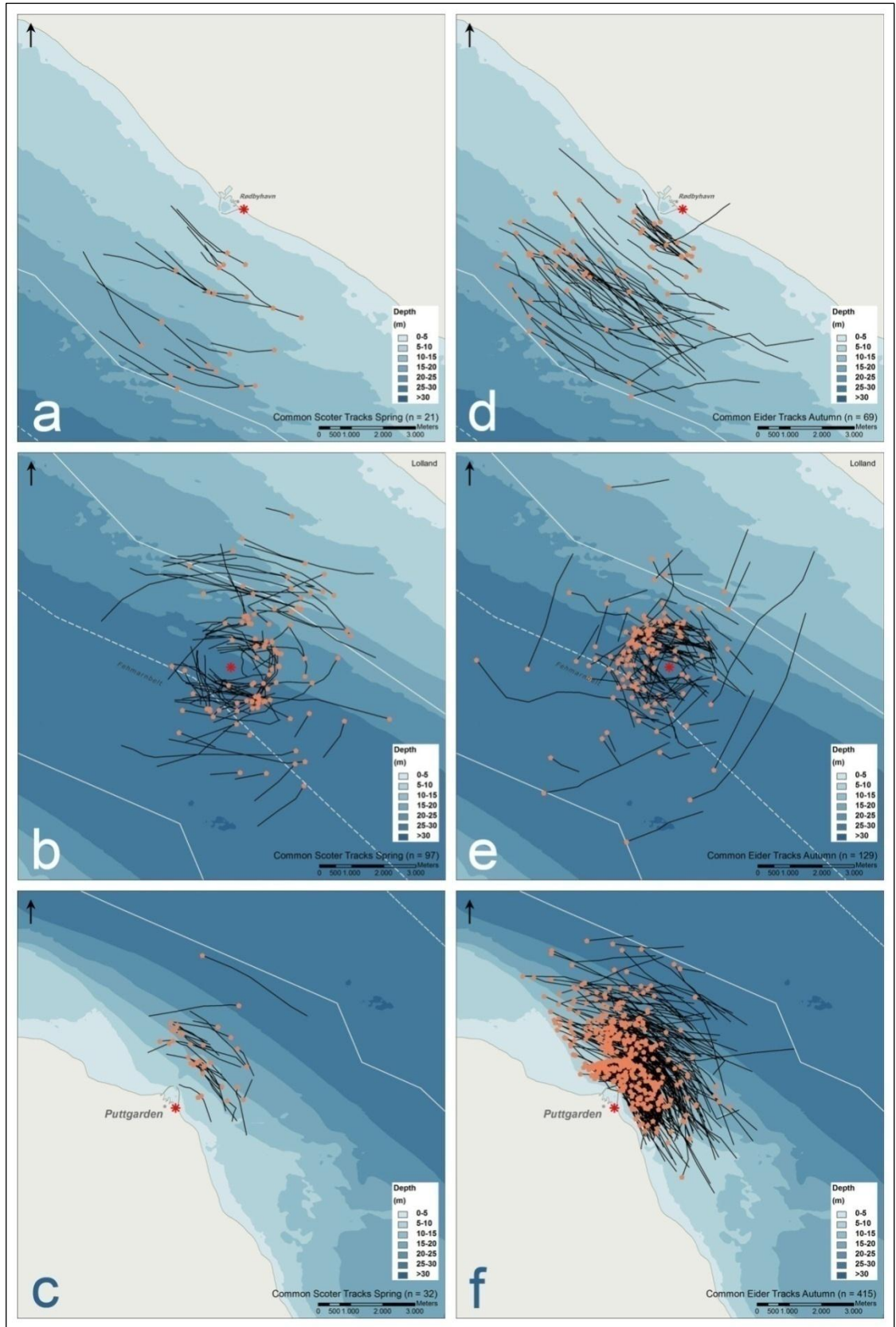

Figure 4.30 Tracks of type 1 species Common Scoter in spring (a, b, c) and Common Eider in autumn (d, e, f) at the Lolland coast (a, d), offshore (b, e) and Fehmarn coast (c, f). Red asterisk indicates position of the radar stations (offshore: ship position).

FEHMARNBELT BIRDS

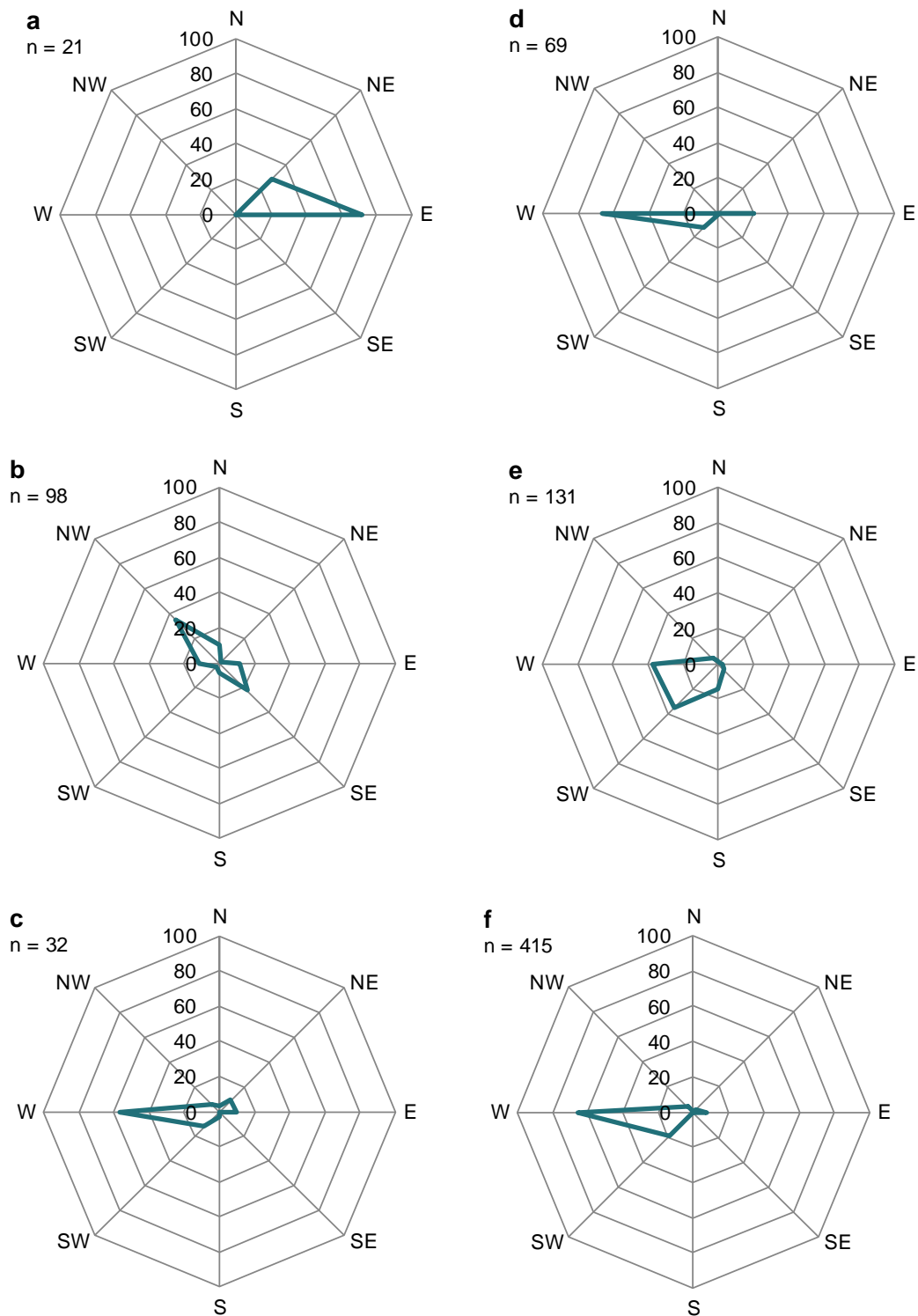

Figure 4.31 Flight directions of type 1 species Common Scoter in spring (a, b, c) and Common Eider in autumn (d, e, f) at the Lolland coast (a, d), offshore (b, e) and Fehmarn coast (c, f). (For values see Table 4.19).

FEHMARNBELT BIRDS

Type 3 species – spring

Of the species departing from the Fehmarn coast, birds of prey as a species group and the individual species Honey Buzzard and Wood Pigeon showed a significant mean flight direction and matched the expected flight direction of 25° towards Rødbyhavn, thus crossing Fehmarnbelt at the shortest distance (Figure 4.32, Figure 4.33 and Table 4.19). Common Swift was also significantly close to the expected direction, but turning rather N. While the sample sizes offshore for these species were too low to be entered into the analysis, at the Lolland coast birds of prey and in particular Honey Buzzards headed to inland areas in the expected direction. Figure 4.32 and Figure 4.33 indicate a lower degree of variability in the NE direction of type 3 species at the arriving coast (Lolland) as compared to the departing coast (Fehmarn).

Type 3 species – autumn

During autumn, birds of prey and passerines, and in particular Wood Pigeon showed significant mean migration directions at the Lolland coast to set out to cross the Fehmarnbelt close to 205° towards Puttgarden (Figure 4.32, Figure 4.33, Table 4.19). For birds of prey this was observed to apply also to the offshore area as well as the Puttgarden coast. At the Fehmarn coast a number of species groups and individual species arrived and continued onwards as expected, such as birds of prey and pigeons. Figure 4.32 and Figure 4.33 indicate a lower degree of variability in the SW direction of type 3 species at the arriving coast (Fehmarn) as compared to the departing coast (Lolland).

FEHMARNBELT BIRDS

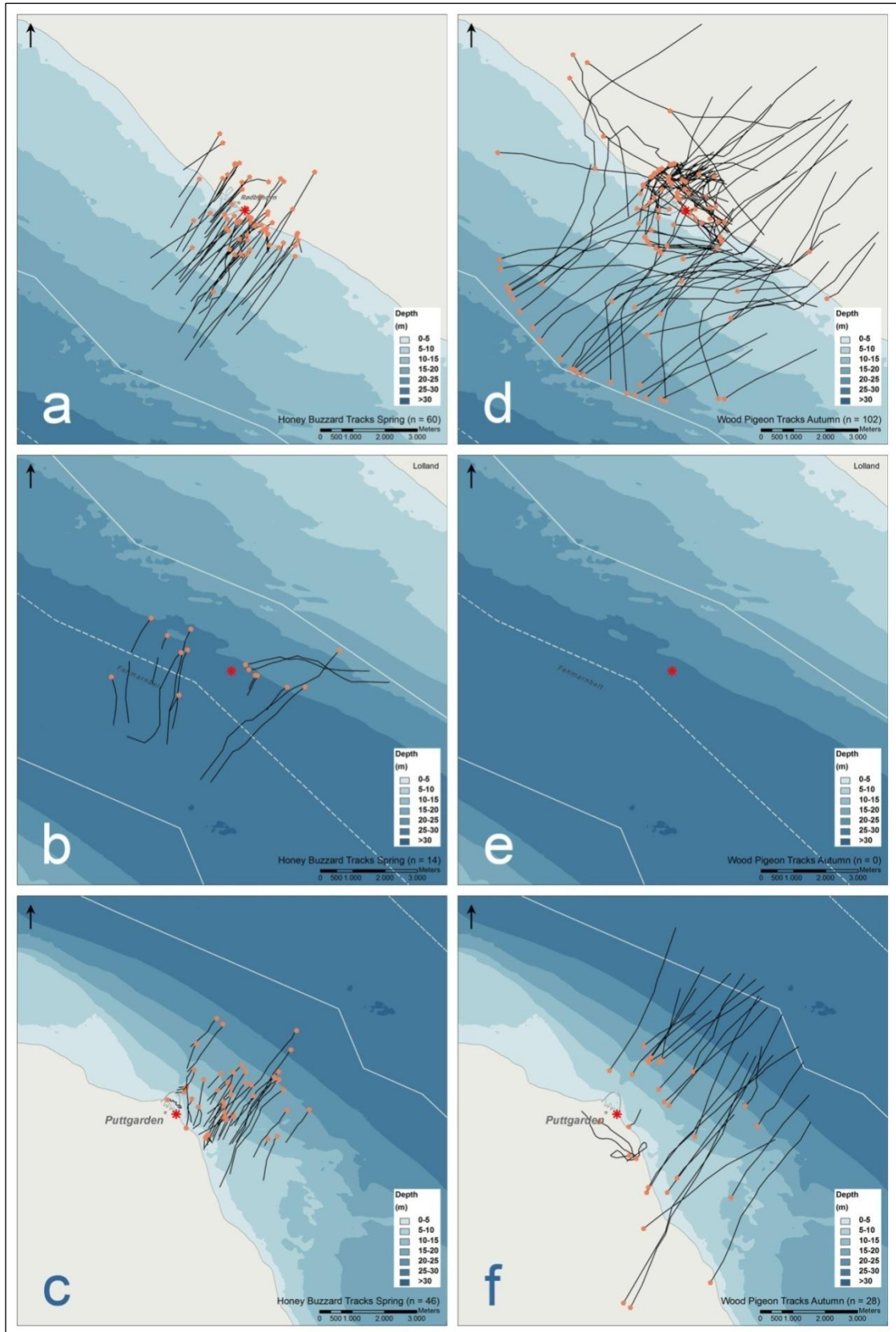

Figure 4.32 Tracks of type 3 species Honey Buzzard in spring (a, b, c) and Wood Pigeon in autumn (d, e, f) at the Lolland coast (a,d), offshore (b, e) and Fehmarn coast (c, f). Red asterisk indicates position of the radar stations (offshore: ship position).

FEHMARNBELT BIRDS

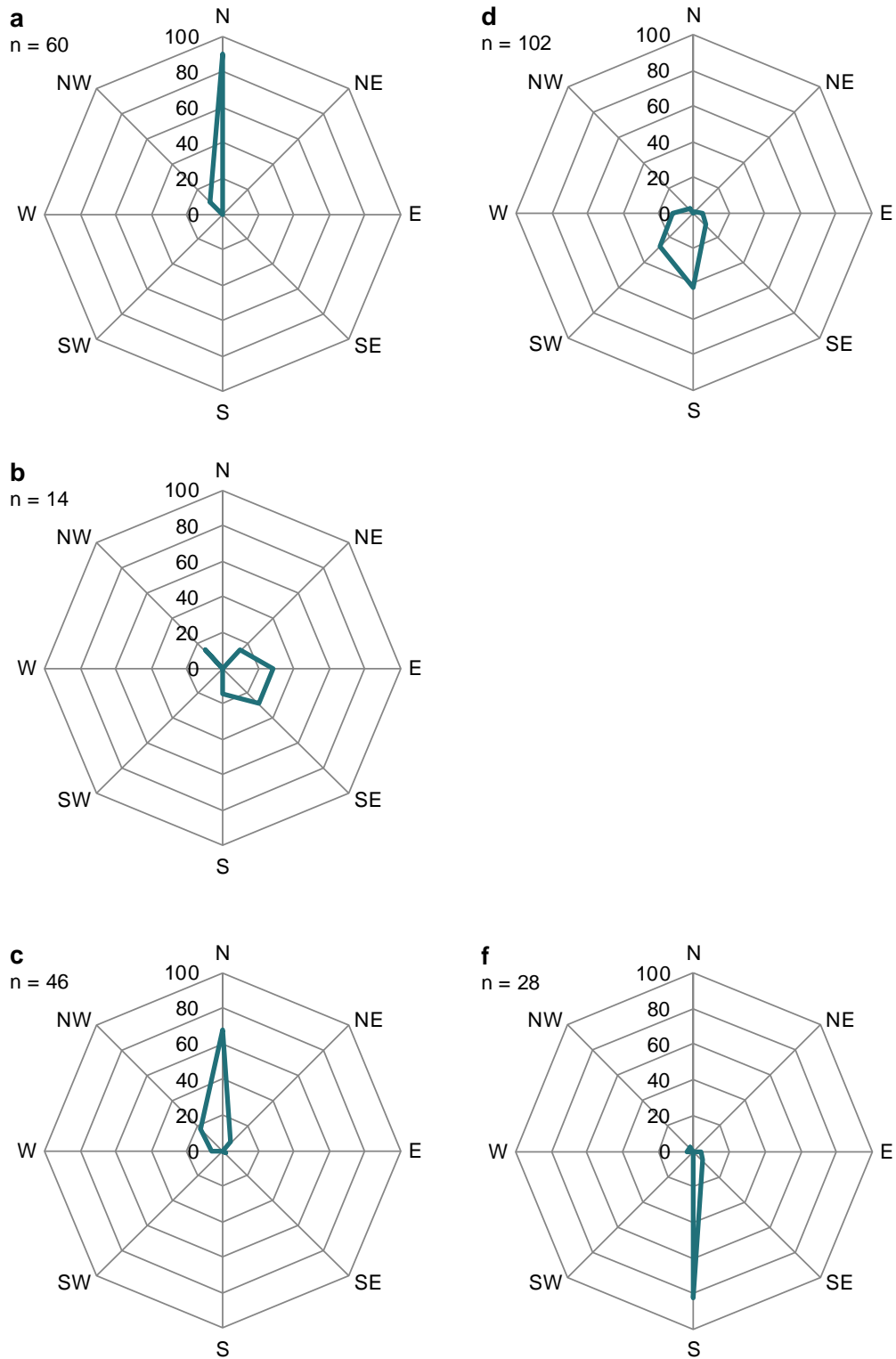

Figure 4.33 Flight directions of type 3 species Honey Buzzard in spring (a, b, c) and Wood Pigeon in autumn (d and f, no data for offshore) at the Lolland coast (a,d), offshore (b) and Fehmarn coast (c, f). (For values see Table 4.19).

FEHMARNBELT BIRDS

Other species

For goose species, the overall picture is not clear. Of the *Anser* species Greylag and Greater White-fronted Goose, the spring directions were quite variable and in autumn they were close to crossing directions. Flight directions of the *Branta* species Barnacle and Brent Goose were also diverse, sometimes following the coast, sometimes not (Figure 4.34, Figure 4.35 and Table 4.19). As typical long-distance migrants, these species may follow a predestined direction independent of topography of coastlines and other features; however, depending on wind direction and speed, their flight might be coast-parallel by chance.

FEHMARNBELT BIRDS

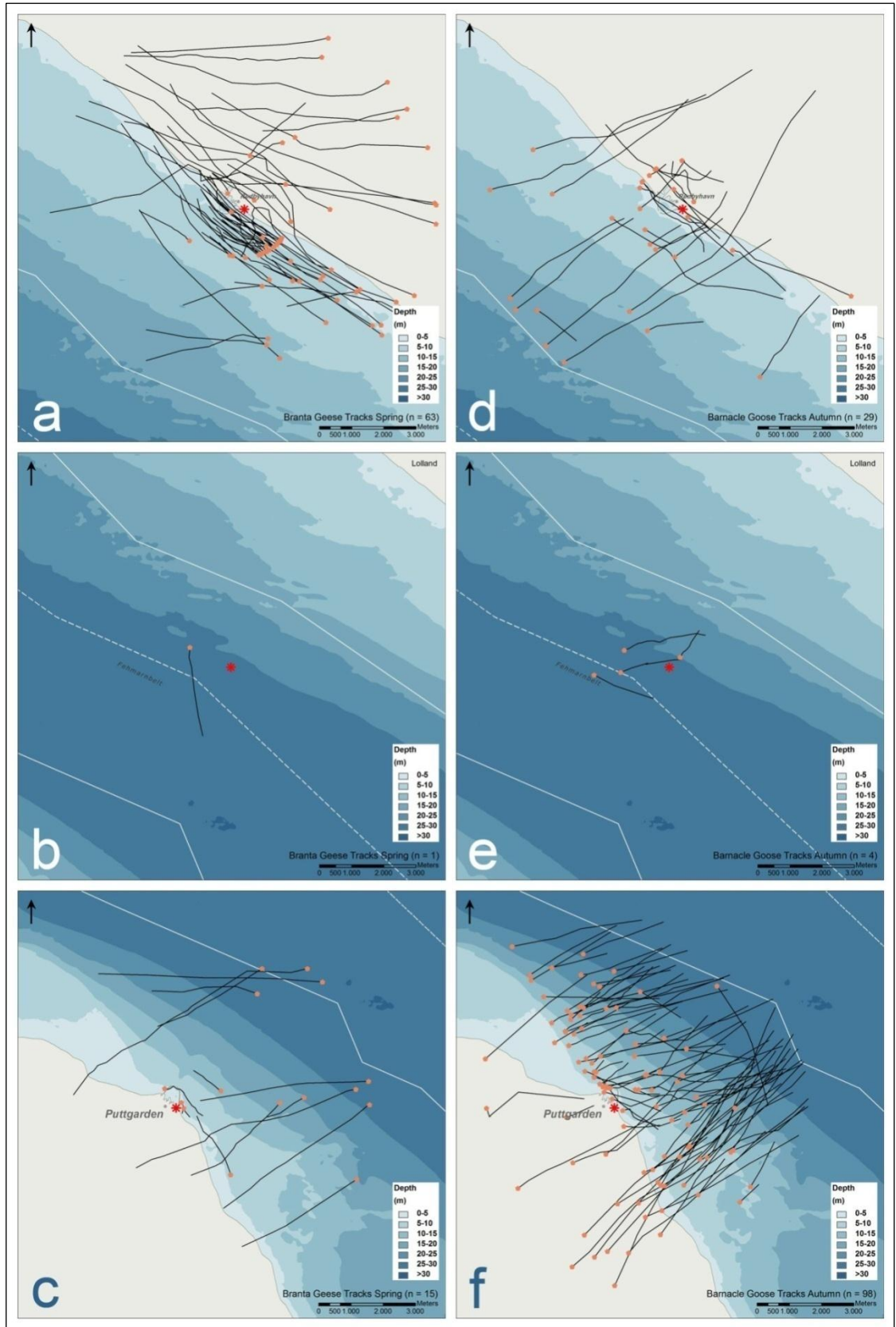

Figure 4.34 Tracks of Branta species (Barnacle and Brent Goose) in spring (a, b, c) and Barnacle Goose in autumn (d, e, f) at the Lolland coast (a, d), offshore (b, e) and Fehmarn coast (c, f). Red asterisk indicates position of the radar stations (offshore: ship position).

FEHMARNBELT BIRDS

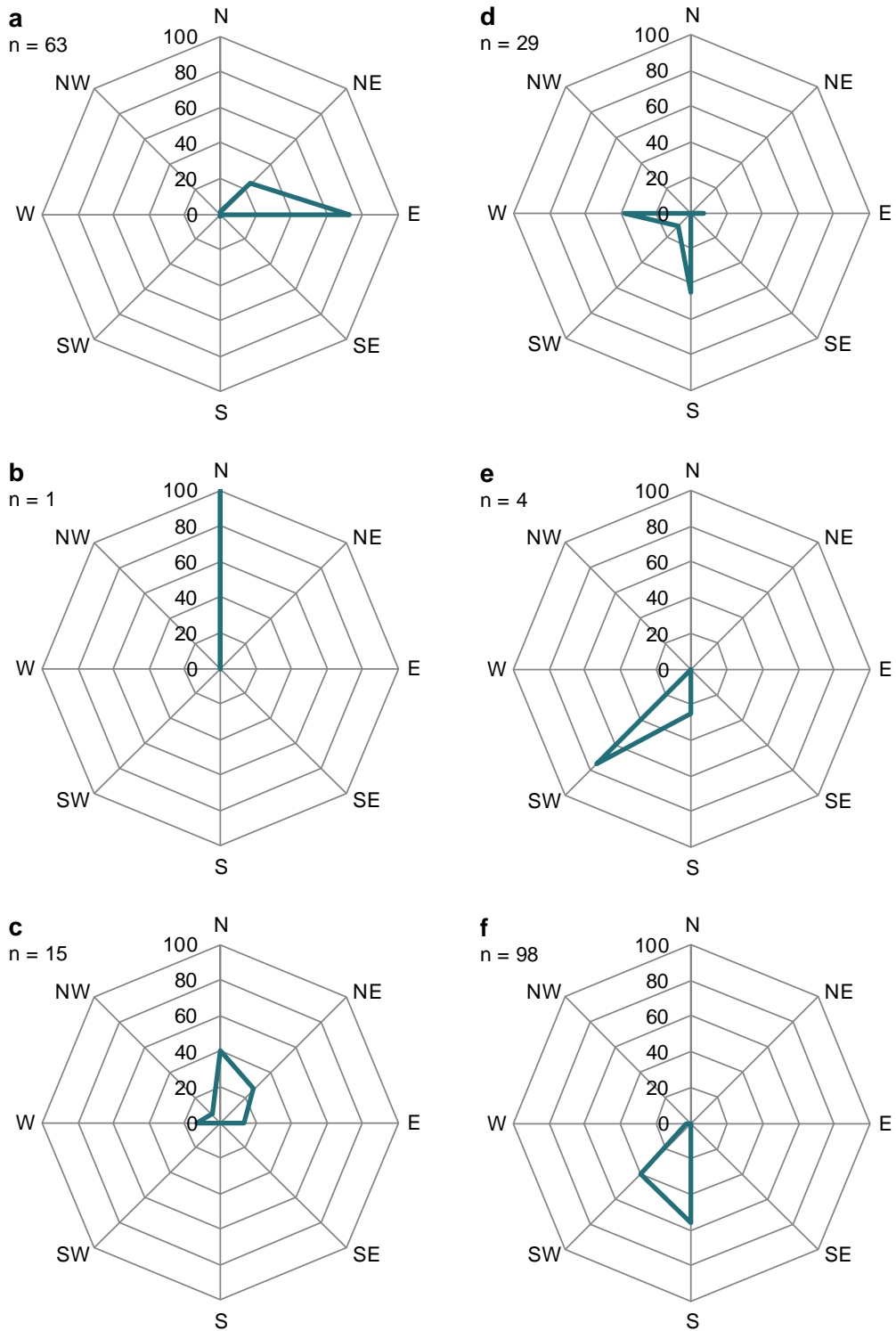

Figure 4.35 Main flight direction of *Branta* species (Barnacle and Brent Goose) in spring (a, b, c) and Barnacle Goose in autumn (d, e, f) at the Lolland coast (a, d), offshore (b, e) and Fehmarn coast (c, f).

FEHMARNBELT BIRDS

Gulls and Great Cormorants are to be treated separately with regard to their movements and behaviour. At both onshore stations they are attracted by the harbour and the harbour wall and other structures that are used for roosting. Sometimes they are responding on passing fishing trawlers. A high number of short-distance movements between roosting and feeding places occur and cannot be discerned from e.g. migration behaviour. However, in some cases flight directions of these species are significant for the mean direction and also for the expected direction, as for example for Great Cormorant in spring.

With regard to offshore structures and potential disturbances, two issues have been registered. The influence of a structure is well documented by the September and October tracks of Common Eiders at Puttgarden, which showed a clear avoidance reaction and thus change of flight tracks due to the structure (Figure 4.36).

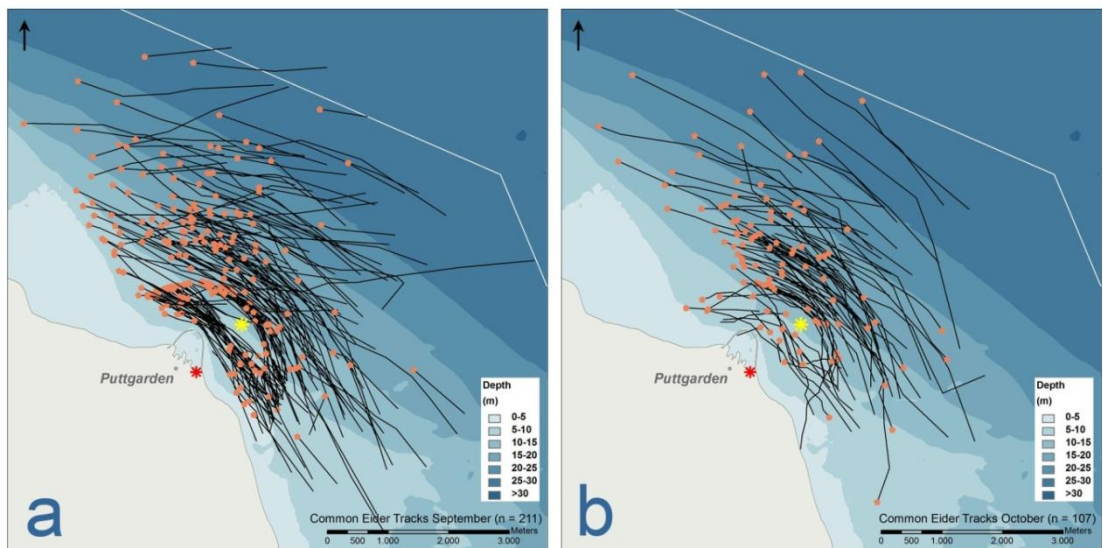

Figure 4.36 Influence of offshore structures, in this case a drilling platform, within the Common Eider migration route near to Puttgarden in September (a) and October (b) 2010. Yellow asterisk indicates position of the drilling platform.

Also, seaduck (Figure 4.30) and diver tracks at the offshore location show, that these tracks apparently avoid the observer vessel "Arne Tiselius" itself (Figure 4.37), while flight tracks at the coast locations are more straight.

FEHMARNBELT BIRDS

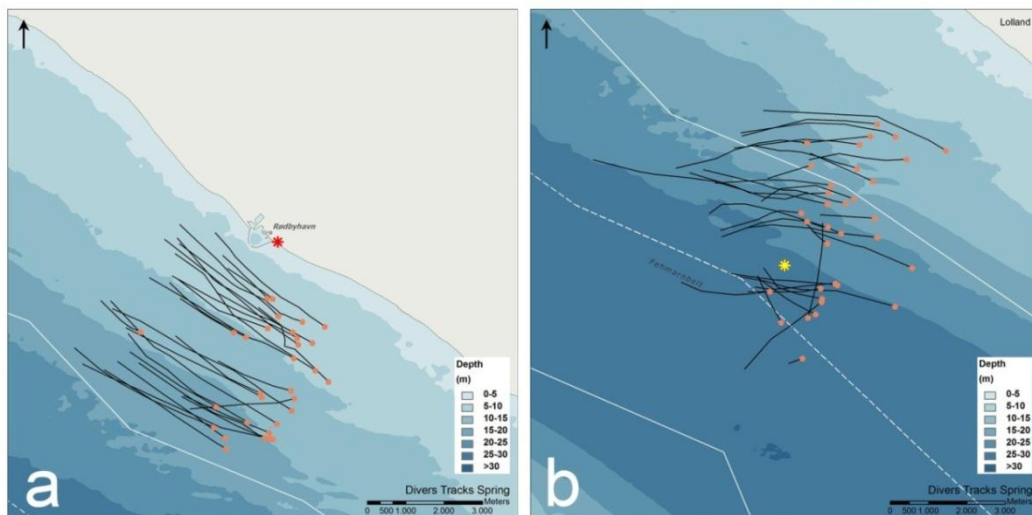

Figure 4.37 Diver flight paths without (a) and with influence of offshore structures, in this case the survey ship "Arne Tiselius" (b). Yellow asterisk indicates position of "Arne Tiselius".

Summary

Track data for the waterbird species which are migrating more or less coast-parallel were compiled for divers, seaducks and dabbling ducks. In spring 2010 most of the observed *Gavia* divers flew parallel to the coastline between the Lolland station and the anchor position of the ship. South of the ship just a few divers have been tracked.

For seaducks, the coasting effect is quite obvious in particular when strong migration movements were recorded (Lolland coast in spring, Fehmarn coast in autumn). While at places where short-distance movements also occurred or numbers of migrating individuals were low, flight directions were observed to be more variable or even opposite to expected migration directions, e.g. for Common Eider and Common Scoter during spring at the Fehmarn coast.

For the species group dabbling ducks less data were available, and statistical significance for coasting directions for this species group was only obtained at the Lolland coast during spring and at the Fehmarn coast during autumn, respectively (here for Eurasian Wigeon and Mallard).

Species crossing the Fehmarnbelt in spring or autumn are usually birds of prey, pigeons and passerines, all following the expected migration direction rather closely. However, tracking passerines is rarely possible on the radar, and accordingly the data available were too few for statistical analyses. For Wood Pigeons, which have been registered at high altitudes in large flocks of more than 1,000 individuals, for the departing birds (spring at Fehmarn, autumn at Lolland) the expected migration directions were all tested to be statistically significant, even though at Lolland during autumn they often were observed flying a curve before crossing. On arrival at Fehmarn, these flocks flew more or less straight. In general, the variability of tracked directions in this group suggests that birds depart the coastal areas using a larger range of behaviours as compared to the arriving coasts.

In spring Honey Buzzards as well as other bird of prey species flew straight in one direction when near to either coastline. However, in the central Fehmarnbelt their flight directions seem to be more variable.

FEHMARNBELT BIRDS

Table 4.19 Mean flight direction of bird species /groups in relation to expected mean migration direction for a) spring and b) autumn at Lolland, offshore (central) Fehmarnbelt (CFB) and Fehmarn. n = number of tracks; Rayleigh Test with $p < 0.05$ printed in bold = a significant main migration direction exists; V Test with $p < 0.001$ printed in bold = migration direction coincides with expected migration directions; those are "coasting": 130° in spring and 310° in autumn; "crossing": 25° in spring, 205° in autumn.

a) spring data							
	species/species group	n	Mean direction [°]	SE of Mean [°]	Rayleigh (p)	V Test (p)	
						130°	25°
L O L L A N D	<i>Gavia divers</i>	31	122	1.6	< 0.001	< 0.001	0.82
	<i>Branta</i> geese	64	118	2.8	< 0.001	< 0.001	0.731
	grey geese	35	95	18.1	0.008	0.006	0.151
	dabbling ducks	35	128	13.1	< 0.001	< 0.001	0.812
	swans	30	342	18.3	0.01	0.995	0.014
	waders	65	111	4.2	< 0.001	< 0.001	0.27
	birds of prey	127	37	2.1	< 0.001	0.78	< 0.001
	Great Cormorant	168	207	22.0	0.035	0.285	0.995
	Brent Goose	40	124	2.1	< 0.001	< 0.001	0.912
	Common Eider	664	127	1.6	< 0.001	< 0.001	1
	Honey Buzzard	60	35	1.8	< 0.001	0.798	< 0.001
	Black-headed Gull	34	75	33.8	0.246	0.168	0.142
	Common Gull	46	66	9.0	< 0.001	0.006	< 0.001
Herring Gull	109	33	16.8	0.003	0.652	< 0.001	
C F B	divers	36	95	5.9	< 0.001	< 0.001	0.009
	seaducks	154	88	10.1	< 0.001	< 0.001	0.006
	gulls	329	78	10.6	< 0.001	< 0.001	< 0.001
	Great Cormorant	55	78	38.0	0.324	0.178	0.184
	Common Scoter	97	100	6.5	< 0.001	< 0.001	0.017
	Common Eider	46	301	21.9	0.036	0.995	0.389
	Common Gull	35	69	23.7	0.059	0.129	0.043
Herring Gull	159	59	21.6	0.031	0.197	0.014	
F E H M A R N	grey geese	59	54	20.6	0.023	0.251	0.008
	dabbling ducks	63	313	14.2	< 0.001	1	0.12
	birds of prey	75	33	6.1	< 0.001	0.841	< 0.001
	gulls	1760	252	57.5	0.609	0.702	0.751
	Great Cormorant	236	354	43.4	0.42	0.83	0.13
	Mute Swan	32	5	74.4	0.747	0.669	0.236
	Greylag Goose	37	307	69.4	0.715	0.794	0.432
	Mallard	38	311	21.9	0.037	0.995	0.24
	Common Scoter	32	317	12.7	< 0.001	1	0.061
	Common Eider	291	313	8.3	< 0.001	1	0.019
	Honey Buzzard	46	31	4.5	< 0.001	0.912	< 0.001
	Common Gull	144	104	32.9	0.222	0.059	0.373
	Herring Gull	1310	243	22.6	0.04	0.842	0.977
Greater Black-backed Gull	244	21	28.8	0.139	0.742	0.024	
Wood Pigeon	33	11	9.9	< 0.001	0.994	< 0.001	

FEHMARNBELT BIRDS

b) autumn data							
	species/species group	n	Mean direction [°]	SE of Mean [°]	Rayleigh (p)	V Test (p)	
						310°	205°
L O L L A N D	dabbling ducks	34	185	26.7	0.107	0.884	0.023
	birds of prey	52	232	7.5	< 0.001	0.08	< 0.001
	passerines	88	163	9.6	< 0.001	1	< 0.001
	Great Cormorant	238	237	18.2	0.007	0.187	0.004
	Common Eider	69	301	7.8	< 0.001	< 0.001	0.763
	Greylag Goose	30	218	11.9	< 0.001	0.571	< 0.001
	Black-headed Gull	37	244	15.2	0.001	0.068	0.003
	Common Gull	42	5	40.4	0.372	0.21	0.907
	Herring Gull	64	217	23.5	0.055	0.543	0.009
	Wood Pigeon	102	245	4.7	< 0.001	< 0.001	< 0.001
	Rook	41	58	19.6	0.016	0.815	0.992
C F B	bird of prey	34	221	2.6	< 0.001	0.452	< 0.001
	gulls	112	180	23.2	0.049	0.942	0.013
	Great Cormorant	30	211	9.6	< 0.001	0.784	< 0.001
	Common Eider	131	284	3.7	< 0.001	< 0.001	0.010
	Herring Gull	45	160	15.6	< 0.001	0.999	< 0.001
F E H M A R N	greypeese	70	238	7.0	< 0.001	0.011	< 0.001
	birds of prey	53	217	3.6	< 0.001	0.68	< 0.001
	pigeons	31	219	7.0	< 0.001	0.529	< 0.001
	Great Cormorant	489	300	11.2	< 0.001	< 0.001	0.675
	Barnacle Goose	98	244	2.2	< 0.001	< 0.001	< 0.001
	Greylag Goose	30	251	9.6	< 0.001	0.004	< 0.001
	Mallard	101	313	14.5	< 0.001	< 0.001	0.885
	Eurasian Wigeon	63	317	4.2	< 0.001	< 0.001	1
	Common Eider	415	307	2.2	< 0.001	< 0.001	1
	Eurasian Buzzard	33	220	3.7	< 0.001	0.482	< 0.001
	Black-headed Gull	45	310	11.3	< 0.001	< 0.001	0.891
	Common Gull	87	235	38.9	0.34	0.354	0.101
	Herring Gull	562	301	5.6	< 0.001	< 0.001	0.851
	Greater Black-backed Gull	141	278	14.9	< 0.001	< 0.001	0.134
Rook	98	301	24.8	0.072	0.012	0.594	
Jackdaw	64	310	9.4	< 0.001	< 0.001	0.926	

4.3.3 Flight directions and flight paths - horizontal surveillance radar screenshot data

Introduction

As the visual observations provide no information about the flight directions during nights and periods of poor visibility, and the real-time tracking (chapter 4.3.2) reflects a selection of tracks made by the observers during the daytime, the screenshots of the horizontal radars constituted important supplementary

FEHMARNBELT BIRDS

information about flight directions and intensities 24 hours a day. In addition, the screenshots enabled a comprehensive view of flight directions and flight paths of migrating birds at the three stations, including assessment of the existence of migration corridors, aspects of coasting/departing behaviour of landbird migration, visualisation of selected migration events and documentation of differences in the spatial dynamics of landbird and waterbird migration between day and night.

Results of the visual observations indicated that certainly waterbird migration at Puttgarden and Rødbyhavn is taking place during the daylight hours. However, the existence of waterbird migration during the night cannot be ruled out. Particularly the moult migration of seaducks along the German coast is known to take place during the evening and early night hours (Nehls & Zöllick 1990). The spatial analysis of the screenshots would allow for proving/disproving the existence of migration corridors used by landbirds, e.g. by comparing the geometry of landbird migration between night-time (expected broad front) and daytime (expected narrow front).

Screenshots were taken via a framegrabber with a dedicated extra program. During autumn 2009, these screenshots were saved when observers were on duty. During 2010 screenshots were saved 24 hours a day every day from 20 February 2010 to 23 November 2010. Data obtained from these screenshots have been processed (chapter 3.4.1) in order to obtain information about flight directions and location of flight paths.

Intensities of flight direction categories coast-parallel, crossing, reverse

For migration intensities, the entire area covered by the screenshots has been used, without excluding low-detection zones. The general patterns of migration intensities as reflected by all tracks using the 6 km range during daylight hours are illustrated in Appendix A.7.

The patterns of diurnal migration intensities recorded were in line with the findings of the visual observations, and reflect well the migration peaks of waterbirds and passerines recorded at the stations. This is especially clear from the two land stations, while the recordings from the offshore station, due to the restricted effort, were more difficult to compare with the visual observations. In the following, the major patterns are evaluated in detail against the findings of the visual.

Daytime – coast-parallel tracks

During spring 2010, the phenology patterns of the coast-parallel radar tracks at Puttgarden followed the general tendency in the visual observations of waterbirds with the bulk of migration being recorded between March 27 and April 13 (Appendix A.2, Appendix A.7). During this period, only a small proportion of coast-parallel tracks were moving in westerly directions which again indicate that these movements were dominated by waterbirds, in particular Common Eider. Peak intensities of tracks moving ESE were recorded on April 5, when no observation effort was undertaken at the station. The second highest peak intensities were recorded March 31, coinciding with the peak count at the station (Appendix A.2.7). At Rødbyhavn, the major movement of coast-parallel radar tracks took place during the period March 26 to April 18 with the peak intensities recorded on April 13 (Appendix A.7). No observation effort was undertaken on this date. The periodicity and the low proportion of reversed migration directions

FEHMARNBELT BIRDS

indicate that the movements of coast-parallel tracks in spring at Lolland were dominated by waterbirds.

In May few coast-parallel movements were recorded at Puttgarden (Appendix A.7), while prominent movements were recorded at Rødbyhavn between May 10 and May 20, with peak intensities recorded on May 10 and May 14 (Appendix A.7). On May 20 both land stations were active, and both noted low levels of migrations. Yet, as the period was dominated by the main movement of Barnacle Goose during spring, and large numbers were observed on May 11 (Appendix A.2.6), it is possible that the radar tracks were also mainly reflecting this migration. In late May and early June (May 27 – June 6) rather high intensities of coast-parallel tracks were recorded at Rødbyhavn both during the daylight and night hours (see below). The intensities recorded at Puttgarden during this period were significantly lower. This period reflects the main migration of Arctic waders through the Fehmarnbelt, and the patterns stress the findings from the visual observations that most waders pass in proximity to the Lolland coast. During this some reverse directions were also recorded for the coastal tracks. Peak intensities were recorded May 31 and June 3. No observation effort was undertaken at the station on May 31.

During the period of June and July few coastal movements were recorded at Puttgarden (Appendix A.7), while some more tracks were recorded at Rødbyhavn (Appendix A.7), especially during June 20 – June 27 and July 23 – July 27. Peak track intensities were recorded on July 26, at which data no observation effort was undertaken at the station. Moulting migration of Common Eider was recorded by the visual observations throughout this period. However, the days with higher numbers were not confined to the periods identified by the radar (Appendix A.2.7).

The progress of autumn migration was clearly reflected in the coast-parallel track data from both land stations, yet intensities at Rødbyhavn were much higher than at Puttgarden (Appendix A.7). This fact together with the temporal pattern suggest that both waterbird and landbird migration was involved. At Puttgarden, the main period of coast-parallel movements was between October 2 and November 7, with equal proportions of tracks moving eastwards and westwards. At Rødbyhavn, medium migration intensities were recorded from September 20 onwards, with maximum intensities recorded in the period between October 10 and 17. During this period only October 10 and 11 had observation effort at this station, and during these two days migration was dominated by large numbers of Wood Pigeons, and medium numbers of Greylag Goose, Barnacle Goose and Common Eider (Appendix A.2.6/7). Peak track intensities were recorded on October 12 and 15. Like in Puttgarden the coast-parallel movements in Rødbyhavn included a high proportion of tracks moving east. Another wave of coast-parallel tracks was recorded here between October 23 and 31, with peak intensities on October 30. The last wave of coast-parallel tracks was recorded at Rødbyhavn November 7 – 14, during which visual observations recorded migration of Wood Pigeon and Common Eider; the horizontal radar measured peak intensities on November 9, the only day in this period without visual observations (Appendix A.2).

The timing of peaks in coast-parallel tracks recorded offshore did not match the peaks recorded in Puttgarden or Rødbyhavn.

FEHMARNBELT BIRDS

Daytime – crossing tracks

The patterns of the crossing tracks were similar to the tendencies in the visual observations of passerines and pigeons with the main period both at Puttgarden and Rødbyhavn extending from March 16 through to April 24 (Appendix A.7). Migration intensities at Puttgarden were approximately twice as high as compared to Rødbyhavn. Peak intensities at Puttgarden were recorded in March: 21, 23 and 28. Observation effort was undertaken on the 23, during which day Wood Pigeons and Jackdaws were dominating (Appendix A.2.14). In May, several smaller peaks of radar tracks were recorded at Puttgarden, including May 24 with large movements of swallows (Appendix A.2.16). Although the intensities of diurnal tracks at Rødbyhavn during spring 2010 displayed the same overall intensities and phenology as at Puttgarden the individual peaks recorded during that period were, however, not identical to those recorded at Puttgarden. At both stations, the majority of crossing tracks were moving in a north-easterly direction.

During the period June to August 2010 several smaller movements of birds crossed the Fehmarnbelt, but it was not until ultimo September that larger number of tracks were recorded moving SW. A well-defined movement of crossing tracks was recorded September 22 at all three stations, and again on September 29 in Puttgarden and Rødbyhavn. Visual observations were undertaken at the beginning and end of this period, and large numbers of *Fringilla* finches (beginning) and Wood Pigeons (end) were observed (Appendix A.2.14/16). The most intensive migration across the Fehmarnbelt took place between October 8 and 17, with peak intensities at Rødbyhavn recorded October 8 and 15, and at Puttgarden October 10. Visual observations on the 8 were dominated by *Fringilla* finches, and Wood Pigeons were generally abundant during this period (Appendix A.2.16). Overall, migration intensities of crossing tracks were several times higher at Rødbyhavn as compared to Puttgarden and the proportion reverse migration and coast-parallel (see above) was several times lower than the proportion which crossed. Several events with medium intensity of crossing tracks took place during late October and early November.

Spatial distribution of flight directions

For migration direction figures and analyses, the entire area of the screenshots has been used, without excluding low-detection zones. However, in Puttgarden during 2009 a blanking sector 154° - 290°, thus mainly S to W from the radar, existed.

Figure 4.38 depicts all tracks recorded during night hours at Puttgarden in April 2010, and provides an example of the data processed for the calculation of mean migration directions. Despite the colour-coding of the track directions it is difficult to determine the trends in flight direction between different parts of the radar range. One characteristic which does stand out is the dominance of the north and northeast directions. Yet tracks moving southeast offshore (possibly waterbirds), are partly hidden in the cloud of northward tracks. Thus, in order to better visualize migration directions, in the following mean track directions for coast-parallel and crossing tracks are described for 1 x 1 km squares. The classification of migration directions into coast-parallel and crossing tracks is described in the Methods (Chapter 2.4.2). Calculated mean track directions do not include reverse directions for the two types of track directions. Mean track directions for all stations and months are given in Appendix A.4.

FEHMARNBELT BIRDS

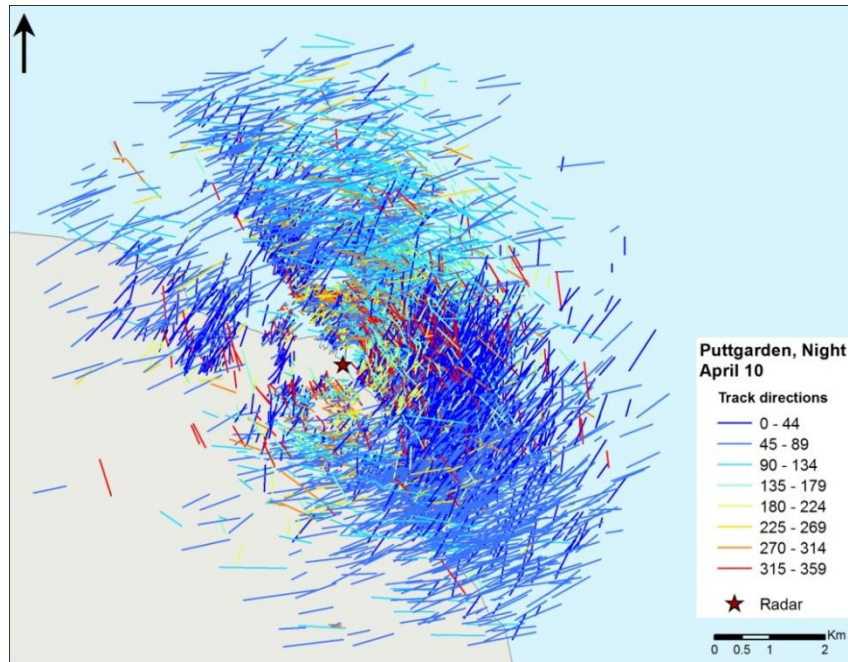

Figure 4.38 Example of flight tracks analysed from horizontal radar screenshots, here nocturnal migration from Puttgarden April 2010 (n=5,699). Flight directions are colour-coded to illustrate the dominance of birds flying north and northeast. Southeast directions over the sea probably represent waterbirds.

Puttgarden

The maps of average daytime migration directions at Puttgarden broken down by months show a strong overall S and SW component both during autumn 2009 and 2010, and a W component offshore, which was mainly apparent in 2010 (Figure 4.39, Figure 4.42). Based on the migration directions the S/SW directions are believed to belong to landbird migration and coincide with passerine and pigeon migration as identified by visual observations, while the W directions belong to waterbirds migrating to northern wintering areas in Danish waters or the North Sea (Appendix A.4.2).

The variation in the recorded average directions during autumn was larger in the 2010 data as compared to the data from 2009 (Figure 4.40, Figure 4.41).

The maps on night-time migration at Puttgarden also show SW migration as the dominant trend during autumns of both years (Figure 4.43, Figure 4.44). Again, the variation in the recorded average directions during spring was larger in the 2010 night-time data as compared to the data from 2009 (Figure 4.46, Figure 4.47).

Both the main periods of waterbird and landbird diurnal migration reflected by the autumn tracks are in agreement with the results of the visual observations (Appendix A.2). A rather intense migration of waterbirds off Puttgarden extended over the whole period from late September to early November. The higher frequency of diurnal waterbird migration relative to nocturnal waterbird migration were clear between September and November, while in July and August, the mean directions at sea indicated the same frequency of waterbird migration during day and night. Judged from the visual observations and night acoustics a prominent westward moult migration of Common Scoters took place during these two months. The moult migration of Common Scoters along the

FEHMARNBELT BIRDS

German Baltic coast is known to take place in July-August (Nehls & Zöllick 1990). The birds typically leave the coast of Estonia in the morning and arrive at Arkona during the evening and early night hours. This migration has been estimated to number 50,000-100,000 individuals (Nehls & Zöllick 1990).

The maps and figures of average directions during spring 2010 (Figure 4.45- Figure 4.47) indicate a much more unidirectional migration at Puttgarden as compared to autumn. A dominance of NE migration over sea was recorded in all spring months both during daytime and night-time, and this trend most certainly reflects the large passage of landbirds and the relatively moderate numbers of waterbirds at Puttgarden during spring. Directions of tracks recorded over the land side at Puttgarden show a remarkable variation as compared to the rest of the radar range. This may be due to the reduced detection of targets south of the radar. The dominance of NE tracks on the coastline indicate that in the observation range a large part of spring migration of landbirds departs from the Fehmarn coast at Puttgarden, rather than follow the coast and depart further southeast at Staberhuk or northwest at Westermarkelsdorf.

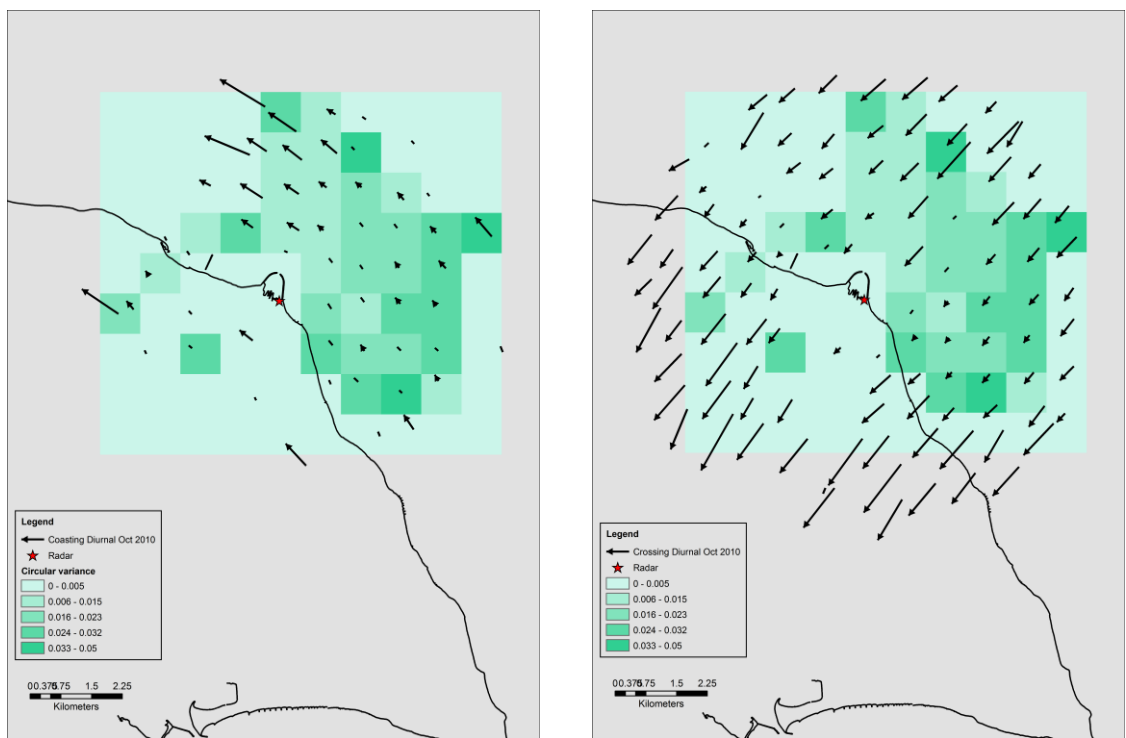

Figure 4.39 Puttgarden autumn 2009 (October 2009), daytime: Track directions for coasting and crossing tracks averaged per km²; data from horizontal radar screenshots with 6 km range (n=6,940). The length of the vectors indicates the average length of tracks at each pixel. The green shading indicates directional variance at each pixel.

FEHMARNBELT BIRDS

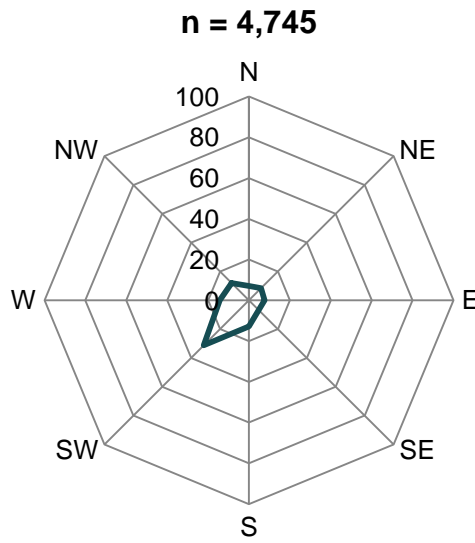

Figure 4.40 A summary of the flight directions daytime at Puttgarden during autumn 2009 with 6 km range.

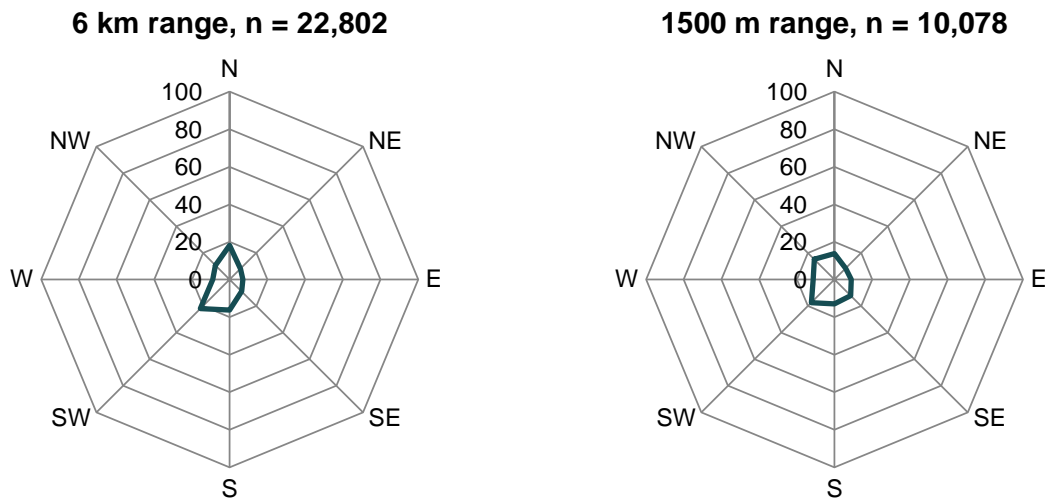

Figure 4.41 A summary of the flight directions daytime at Puttgarden during autumn 2010.

FEHMARNBELT BIRDS

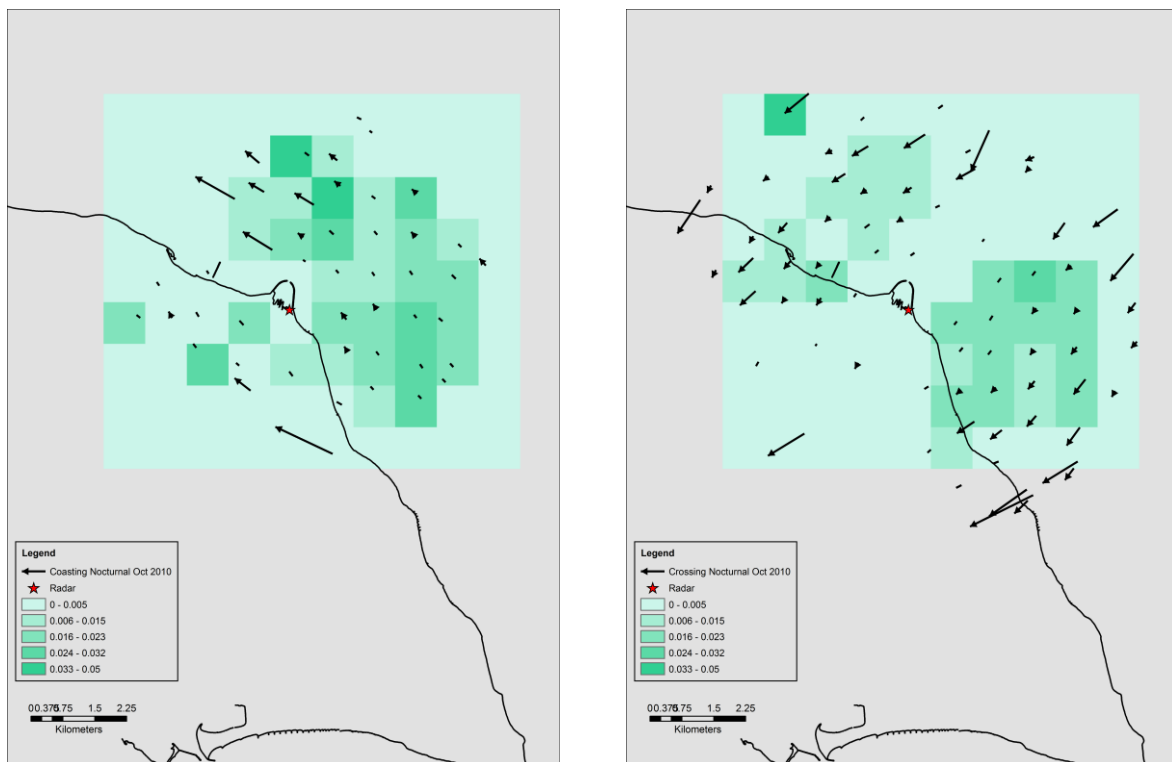

Figure 4.42 Puttgarden autumn 2010 (October 2010), night-time: Track directions for coasting and crossing tracks averaged per km²; data from horizontal radar screenshots with 6 km range (n=5,702). The length of the vectors indicates the average length of tracks at each pixel. The green shading indicates directional variance at each pixel.

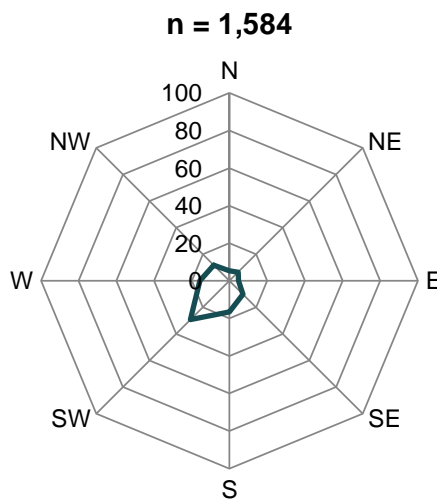

Figure 4.43 Summary of the flight directions during night-time at Puttgarden autumn 2009. Range is 6 km.

FEHMARNBELT BIRDS

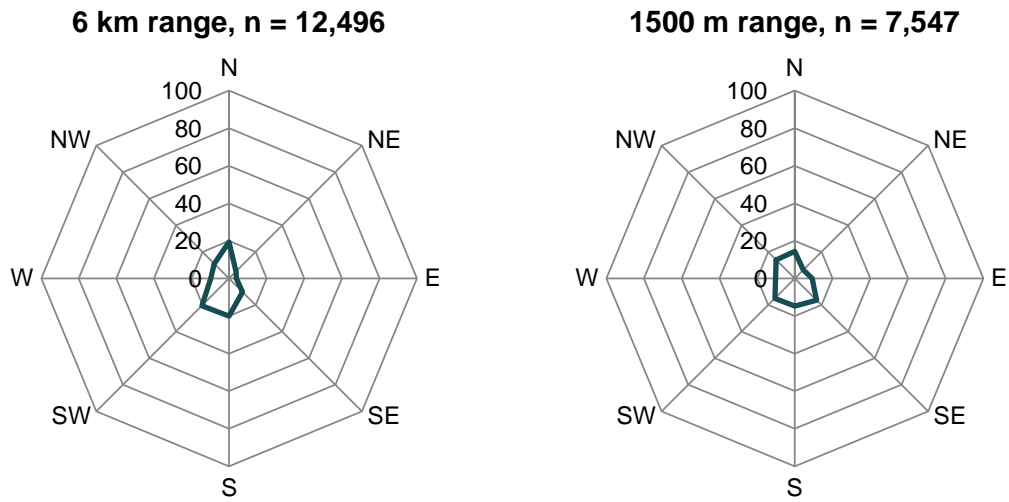

Figure 4.44 Summary of the flight directions during night-time at Puttgarden autumn 2010.

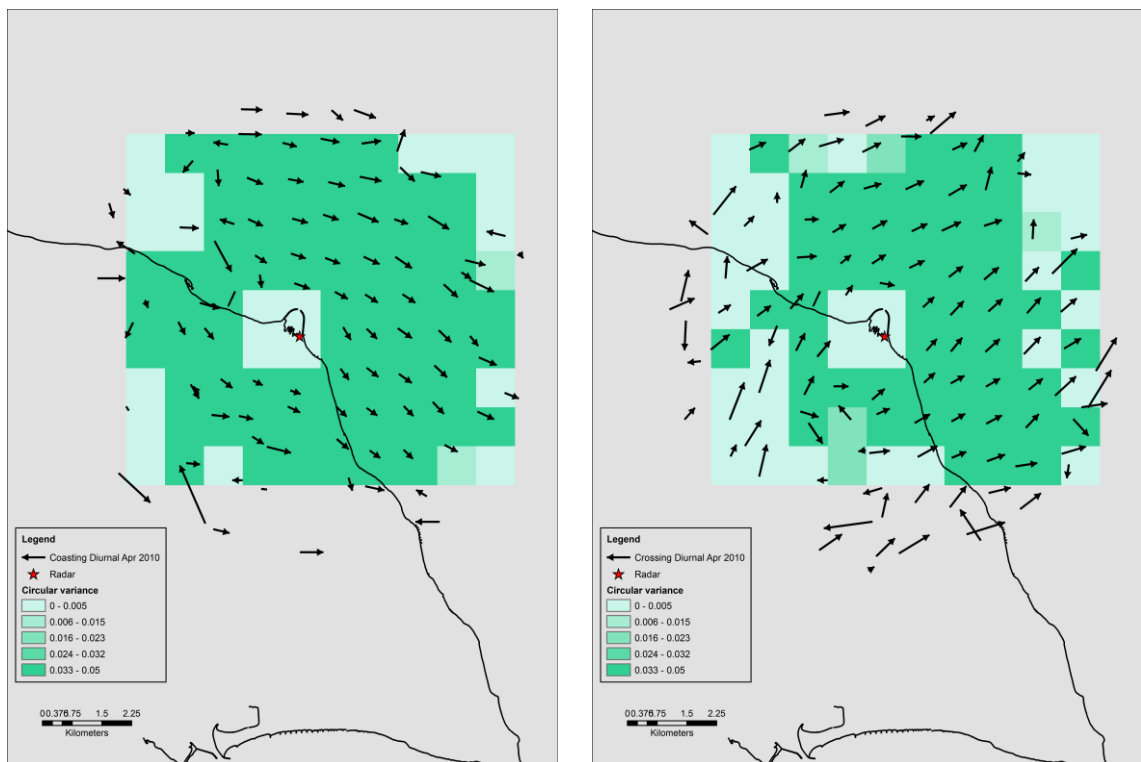

Figure 4.45 Puttgarden spring 2010 (April 2010), daytime: Track directions for coasting and crossing tracks averaged per km²; data from horizontal radar screenshots with 6 km range (n=9,402). The length of the vectors indicates the average length of tracks at each pixel. The green shading indicates directional variance at each pixel.

FEHMARNBELT BIRDS

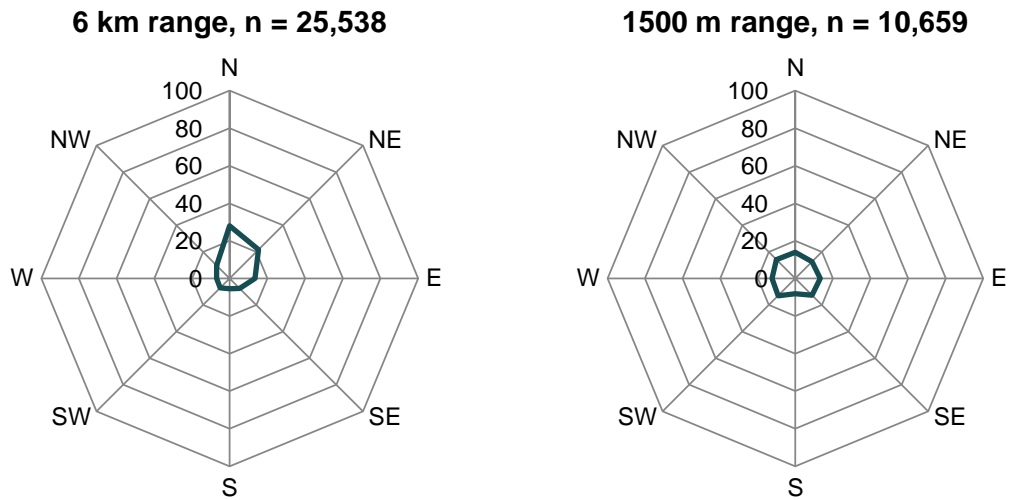

Figure 4.46 A summary of the flight directions daytime at Puttgarden during spring 2010.

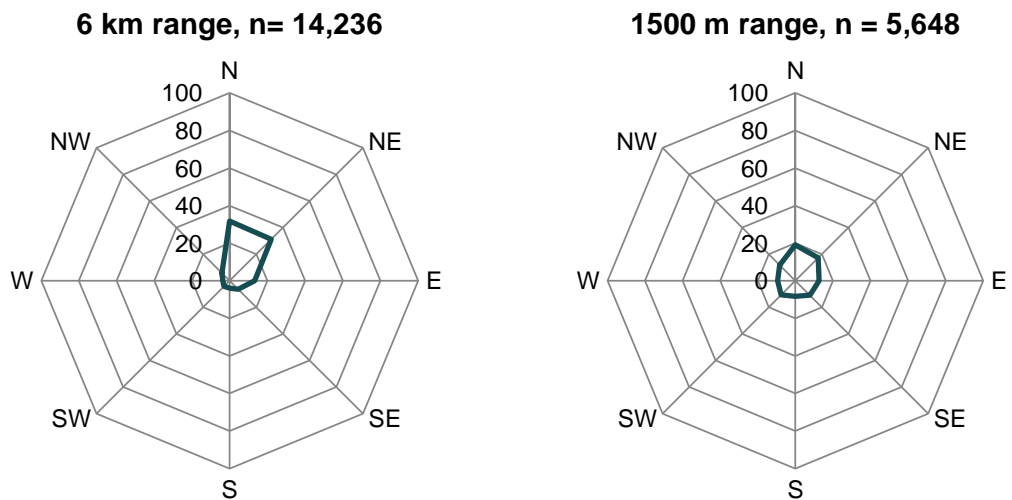

Figure 4.47 Summary of the flight directions during night-time at Puttgarden spring 2010.

Rødbyhavn

The maps on average daytime and night-time migration directions at Rødbyhavn show a strong SSW and SW component both during autumn 2009 and 2010, which based on the prevailing migration direction most likely reflects the large landbird migration at this location (Appendix A.4.3/4), and coincides with passerine and pigeon migration as identified by daytime visual observations (Figure 4.49-Figure 4.52). The dominance of SW and SSW tracks in autumn demonstrates a moderate volume of waterbird migration. The SW tendency of the tracks at the coastline suggests that landbirds depart from Lolland in the region of Rødbyhavn, while coast parallel tracks are less frequent.

The maps on both daytime and night-time migration directions at Rødbyhavn during spring 2010 (Figure 4.53-Figure 4.54) show a strong N and NE movement

FEHMARNBELT BIRDS

of birds, which is believed to be landbird migration and coincides with passerine and pigeon migration as identified by daytime visual observations (Appendix A.2.14/16). The E and SE components, which appear in the summary graphs and which could represent waterbird migration are not reflected in the mean directions over sea in March, but do appear in April and May. Both judged from the summary graphs and the mean directions of the waterbird-like tracks a reduction in the relative frequency of waterbird migration (E and SE directions) is noticeable from daytime to night-time.

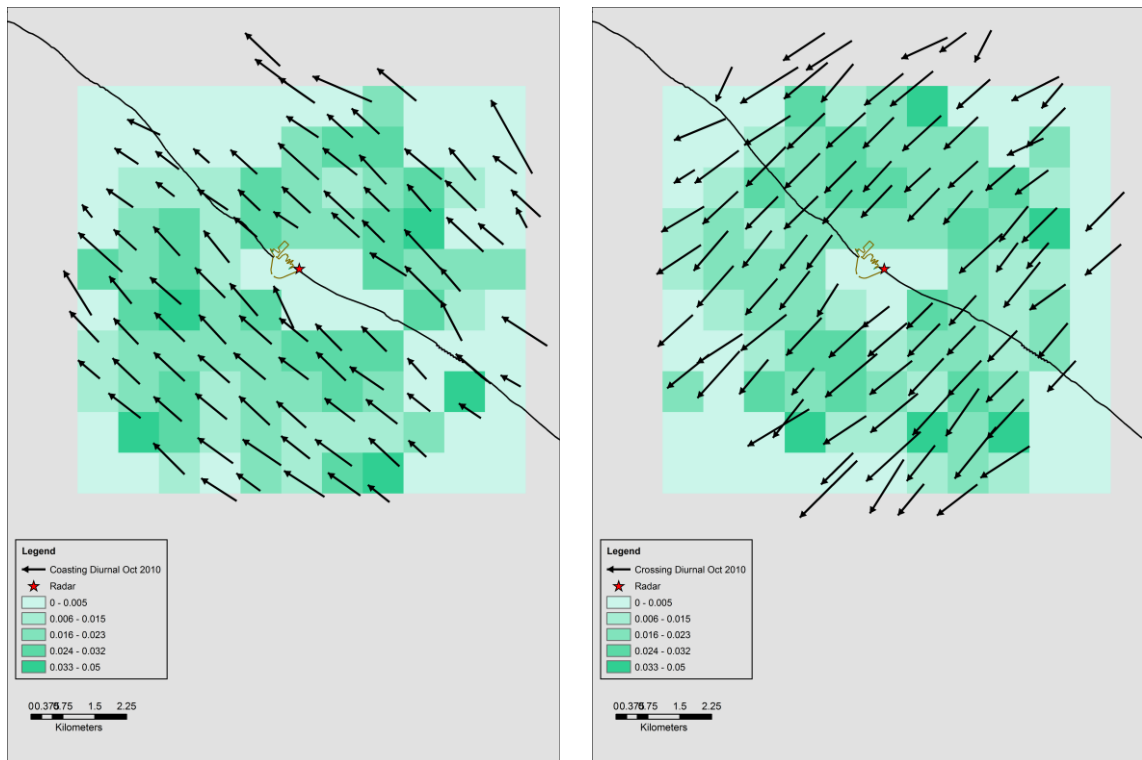

Figure 4.48 Rødbyhavn, autumn 2010 (October 2010), daytime: Track directions for coasting and crossing tracks averaged per km²; data from horizontal radar screenshots with 6 km range (n=14,854). The length of the vectors indicates the average length of tracks at each pixel. The green shading indicates directional variance at each pixel.

FEHMARNBELT BIRDS

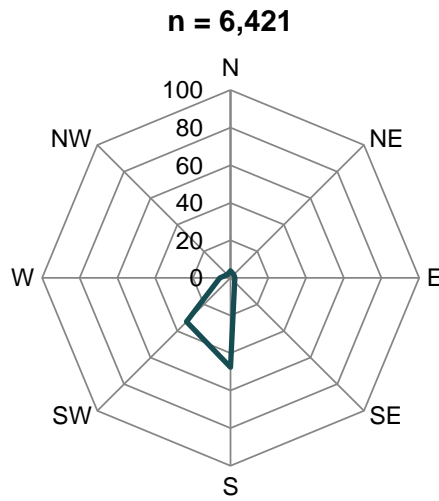

Figure 4.49 A summary of the flight directions daytime at Rødbyhavn during autumn 2009.

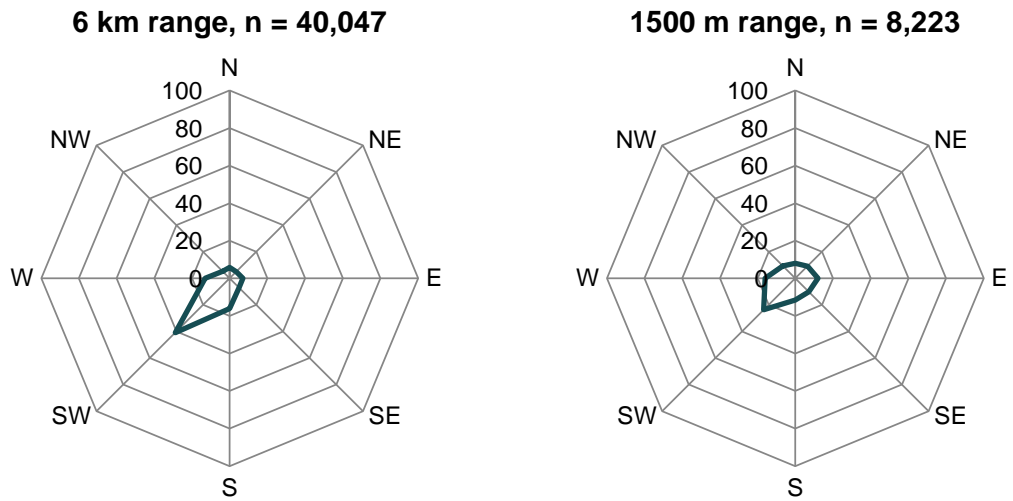

Figure 4.50 A summary of the flight directions daytime at Rødbyhavn during autumn 2010.

FEHMARNBELT BIRDS

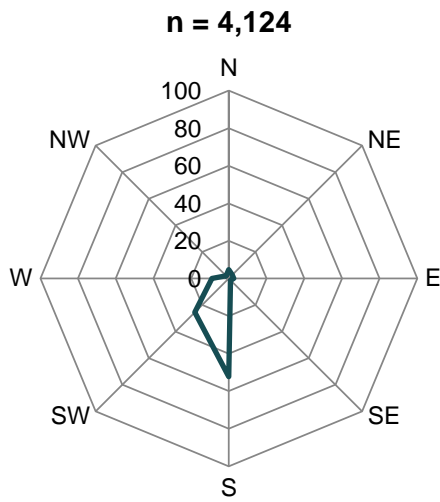

Figure 4.51 A summary of the flight directions night-time at Rødbyhavn during autumn 2009.

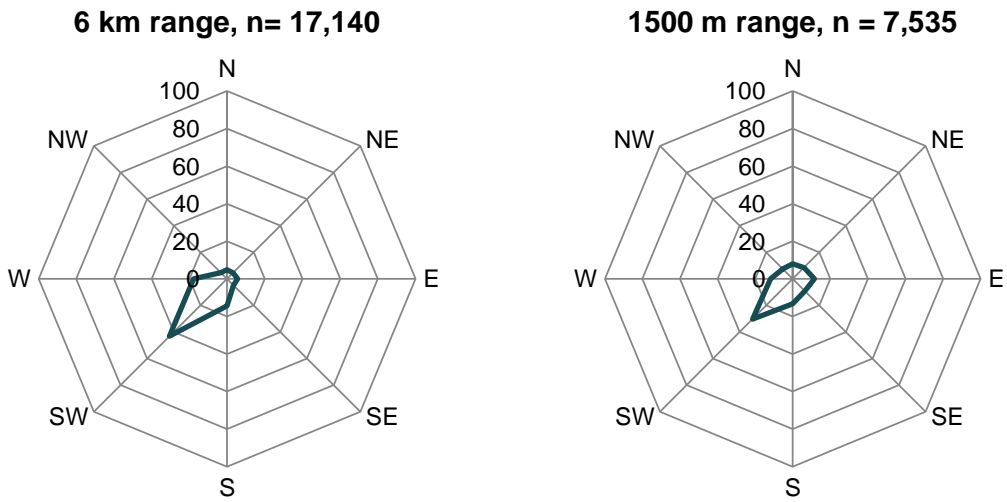

Figure 4.52 A summary of the flight directions night-time at Rødbyhavn during autumn 2010.

FEHMARNBELT BIRDS

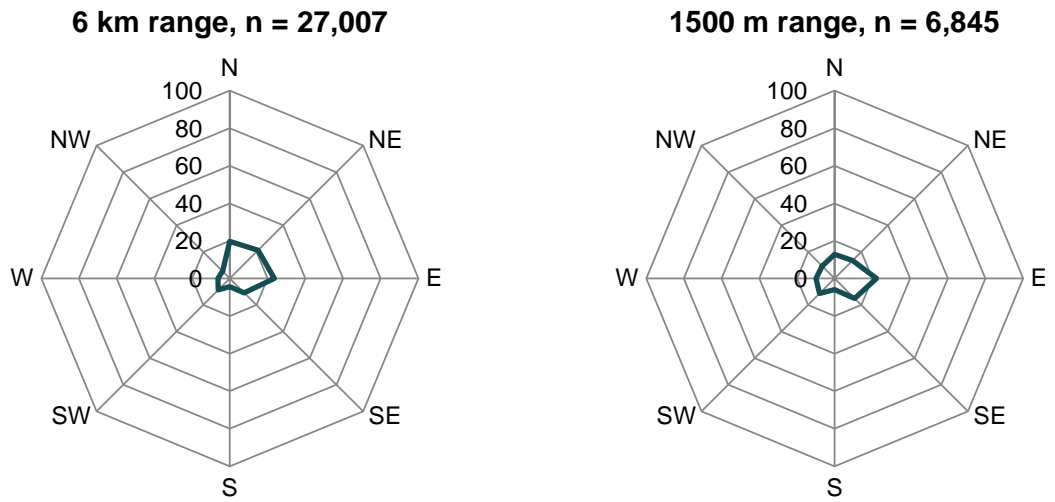

Figure 4.53 Summary of flight directions during daytime at Rødbyhavn spring 2010.



Figure 4.54 Summary of flight directions during night-time at Rødbyhavn spring 2010.

FEHMARNBELT BIRDS

Offshore

The summary figures for daytime and night-time migration directions at the offshore station display a dominance of SW-moving tracks in autumn and NE-moving tracks in spring (Figure 4.55-Figure 4.58). However, in the zone of high track detection directions are predominately SW in autumn and NE in spring, and this is also reflected in the summary graphs.

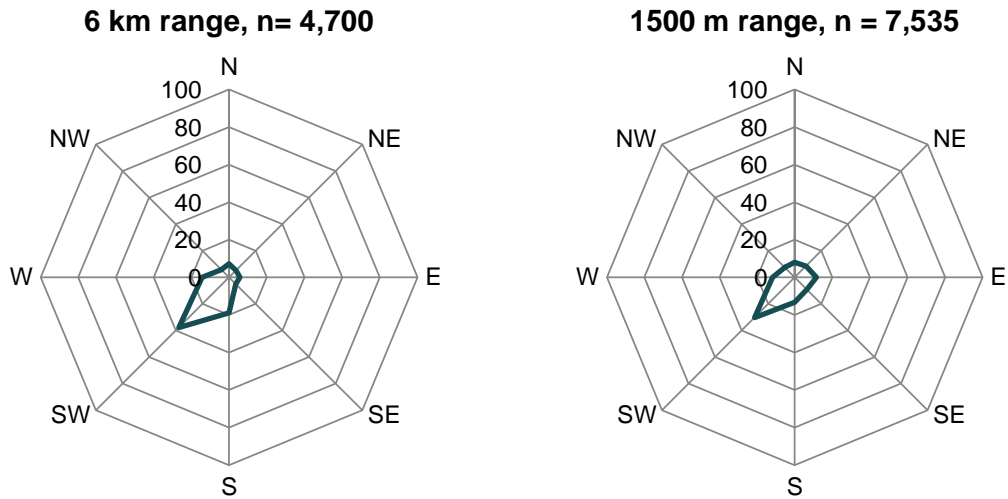

Figure 4.55 Summary of flight directions during daytime Offshore autumn 2010.

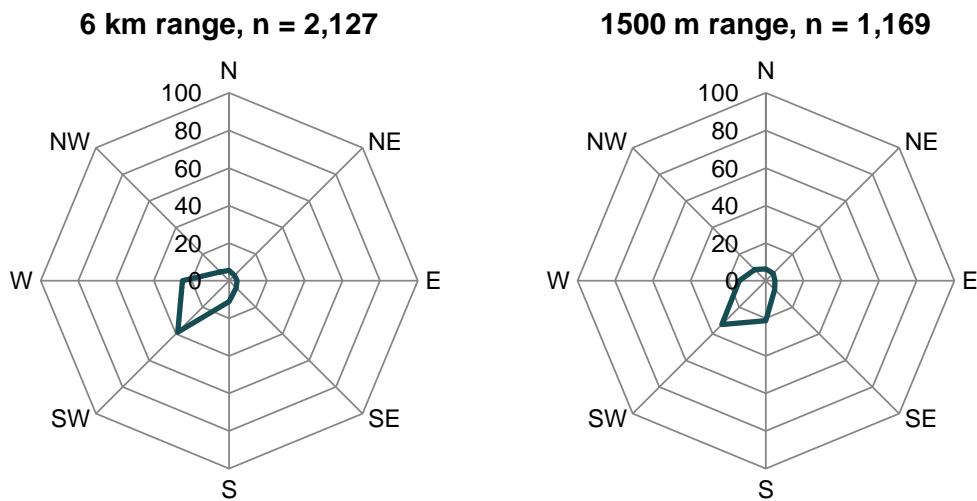

Figure 4.56 Summary of flight directions during night-time Offshore autumn 2010.

FEHMARNBELT BIRDS

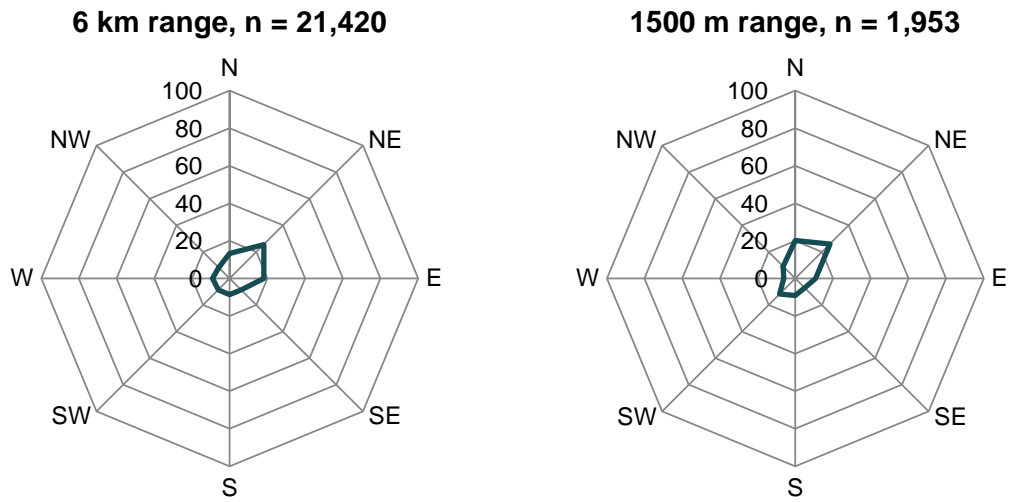

Figure 4.57 Summary of flight directions during daytime Offshore spring 2010.

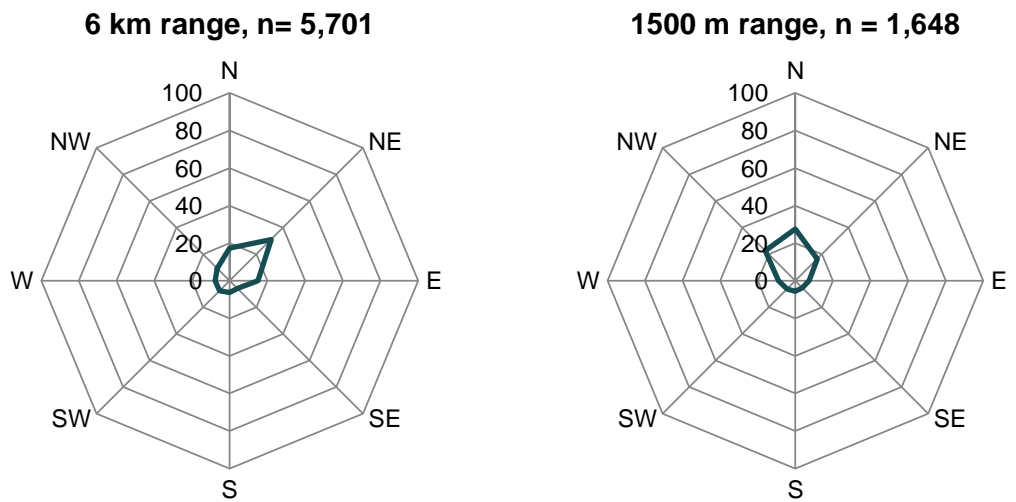

Figure 4.58 Summary of flight directions during night-time Offshore spring 2010.

FEHMARNBELT BIRDS

Spatial distribution of flight paths in relation to the alignment

In the following profiles the number of tracks recorded at Puttgarden and Rødbyhavn are given in relation to distance to coast (waterbird-like tracks) and distance to the planned bridge alignment (landbird-like tracks). The data recorded on both diurnal and nocturnal migration of waterbird-like tracks within the unbiased detection zones indicate the existence of migration corridors off Fehmarn and Lolland with higher migration densities only recorded beyond 1,000 m distance from the coast (Figure 4.59, Figure 4.60).

In Puttgarden in autumn and Rødbyhavn in spring and autumn numbers of tracks seem to increase from 1,000 m from the coast to beyond the range of the unbiased detection zone. During spring, waterbirds seem to move closer to the coast at Puttgarden with a defined peak between 800 and 1,500 m distance. It should be noted that the migration distance to the coast is influenced by the presence of onshore winds (chapter 5.1).

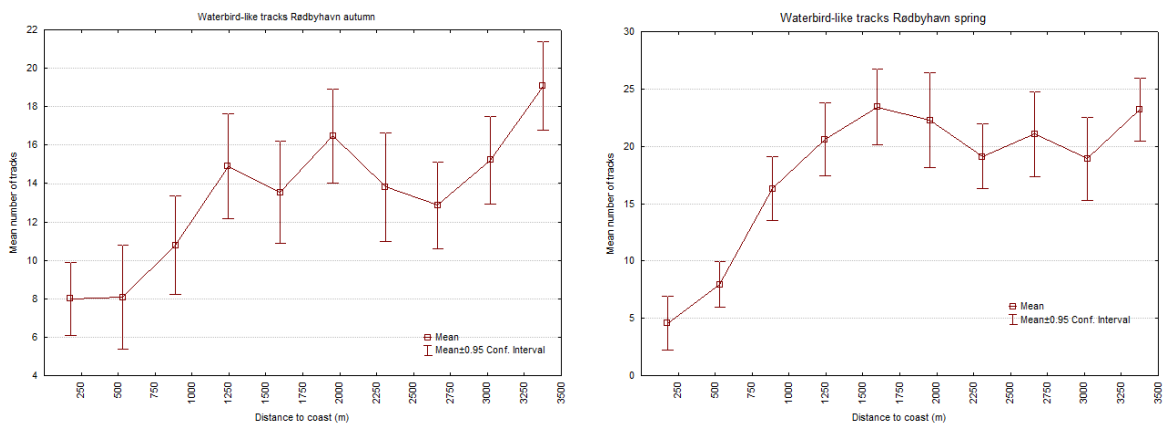

Figure 4.59 Recorded diurnal migration intensities of waterbird-like tracks at different distances from the coast at Rødbyhavn during autumn 2009 and 2010 and spring 2010. The migration intensities represent the mean number of tracks recorded within 250x250 m grid cells. Only grid cells located within the clutter-free range of high detectability (Figure 3.21) have been extracted.

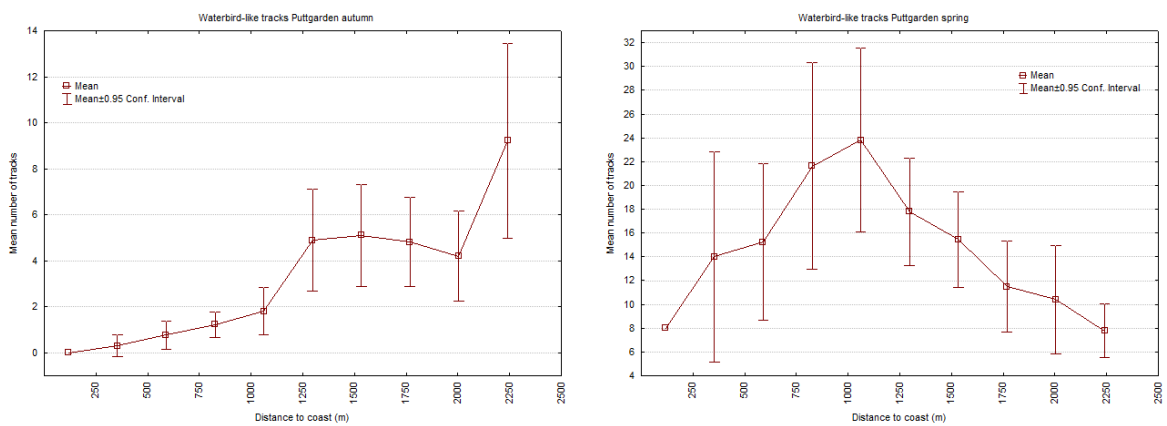

Figure 4.60 Recorded diurnal migration intensities of waterbird-like tracks at different distances from the coast at Puttgarden during autumn 2009 and 2010 and spring 2010. The migration intensities represent the mean number of tracks recorded within 250x250 m grid cells. Only grid cells located within the clutter-free range of high detectability (Figure 3.16) have been extracted.

FEHMARNBELT BIRDS

The profiles of landbird migration (crossing tracks, Figure 4.61 to Figure 4.64) indicate that most landbirds depart close to the alignment at Rødbyhavn during autumn. This trend is apparent both in the nocturnal and diurnal migration. In spring, however, landbirds seem to arrive at Rødbyhavn over a broad front. The patterns at Puttgarden are less clear.

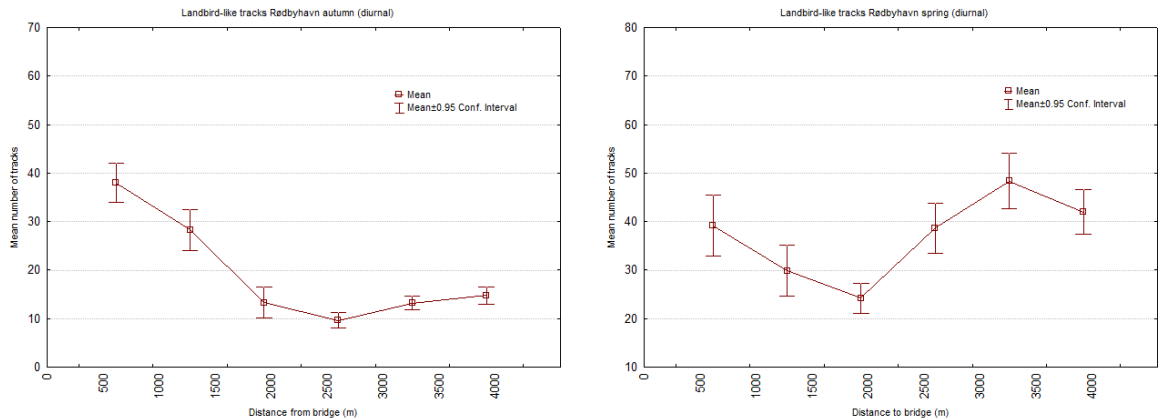

Figure 4.61 Recorded diurnal migration intensities of landbird-like tracks at different distances from the alignment of a fixed link at Rødbyhavn during autumn 2009 and 2010 and spring 2010. The migration intensities represent the mean number of tracks recorded within 250x250 m grid cells. Only grid cells located within the clutter-free range of high detectability east of the alignment (Figure 3.21) have been extracted.

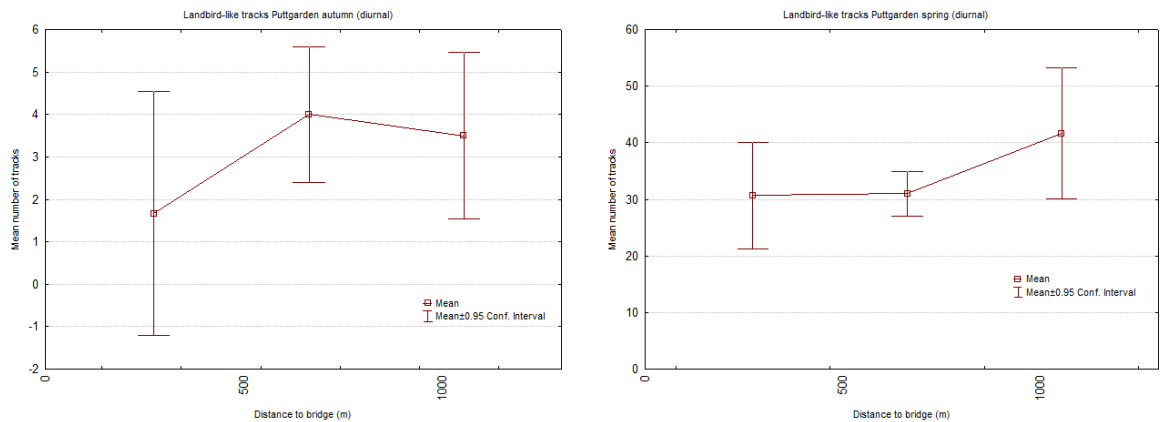

Figure 4.62 Recorded diurnal migration intensities of landbird-like tracks at different distances from the alignment of a fixed link at Puttgarden during autumn 2009 and 2010 and spring 2010. The migration intensities represent the mean number of tracks recorded within 250x250 m grid cells. Only grid cells located within the clutter-free range of high detectability east of the alignment (Figure 3.15) have been extracted.

FEHMARNBELT BIRDS

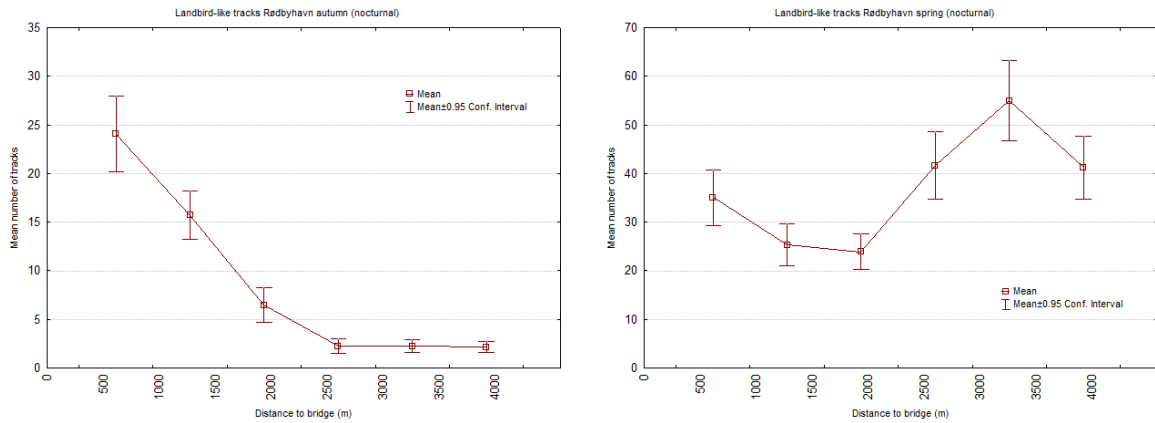

Figure 4.63 Recorded nocturnal migration intensities of landbird-like tracks at different distances from the alignment of a fixed link at Rødbyhavn during autumn 2009 and 2010 and spring 2010. The migration intensities represent the mean number of tracks recorded within 250x250 m grid cells. Only grid cells located within the clutter-free range of high detectability east of the alignment (Figure 3.21) have been extracted.

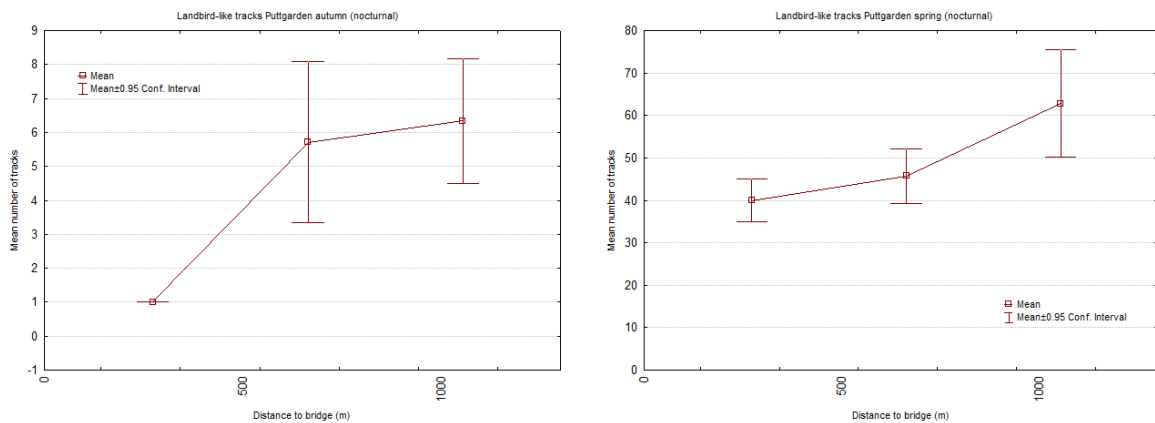

Figure 4.64 Recorded nocturnal migration intensities of landbird-like tracks at different distances from the alignment of a fixed link at Puttgarden during autumn 2009 and 2010 and spring 2010. The migration intensities represent the mean number of tracks recorded within 250x250 m grid cells. Only grid cells located within the limited clutter-free range of high detectability east of the alignment (Figure 3.16) have been extracted.

4.3.4 Summary

The shape of the Fehmarn north coast suggests three potential departure locations during spring migration, namely the NW corner of Fehmarn (Markelsdorfer Huk), the Puttgarden harbour and the SE corner of Fehmarn (Staberhuk) (Berndt et al., 2005). A bird leaving from the north-western tip of Fehmarn has the shortest distance (21.5 km) if it flies directly NNE towards a point on the Lolland coast some 9 km NW from Rødbyhavn. However, Rødbyhavn itself would be only 22.0 km away. A bird leaving from Puttgarden has the shortest distance (18.5 km) to Rødbyhavn. However, distances to the coast up to 6 km SE from Rødbyhavn only differ by 0.5 km. A bird leaving from the south-eastern tip of Fehmarn will fly some 24 km to Hyllekrog (including some 5 km NE of Hyllekrog with very small differences).

FEHMARNBELT BIRDS

The shape of the south coast of Lolland also suggests three departure locations in autumn, namely Hyllekrog, Rødbyhavn and the western end of the southern coast of Lolland between Riddertofte and Vesternæs Strand, where land turns NE. At the latter location, birds may choose to either go to Langeland (16 km) or to Fehmarn, NW tip (25 km). Birds from Rødbyhavn face the shortest distance to Puttgarden (18.5 km), Grüner Brink (18.5 km) or the NW tip (22 km), whereas birds from Hyllekrog may go to Puttgarden (20.5 km) or the south-eastern edge of Fehmarn (23 km). It is a question, whether birds can assess these distance differences. It is more likely that they choose the most favourable route considering their leaving point which depends on a combination of the wind conditions and the optimal flight route considering route length and crossing distance (see chapters 4.3.2, 4.3.3 and 5.1).

If landbirds leaving at Hyllekrog (compared to Rødbyhavn) would be directed towards the Puttgarden area thereby crossing or coming close to the proposed link, their flight directions would be more westerly than those leaving from the Rødbyhavn area. The difference between the direct line between Rødbyhavn and Puttgarden (206° - \sim SSW) and the direct line between Hyllekrog and Puttgarden (240° - \sim WSW) would be 34° . Differences between the observed flight directions as estimated by visual observations do not show this difference. However, these estimates may not be sufficiently accurate.

In the preceding three sub-chapters, the phenomenon on bird migration directions as registered at the different observation locations has been explored using all methods applied. Thus, results have been presented for daytime migrating birds based on visual observations. Analyses of radar observations provide more accurate directions and spatial analyses. They also increase the observation range and provide data for periods of low visibility, in particular night-time.

The conclusion is that waterbird migration is influenced by the leading line effect of the coasts. Migrating birds indeed fly towards the expected migration direction, while short-distance movements introduce some variation in the results, e.g. at Puttgarden in spring, when Common Eider and Common Scoter have been observed to move W.

Although records of migrating waterbirds dominate during the day, several species of waterbirds migrate through the region with comparable frequencies during day and night. The most prominent examples are waders, dabbling ducks and Barnacle Geese. Among the seaducks nocturnal migration of Common Scoters has been confirmed by night acoustics, while nocturnal migration of Common Eider has not been confirmed, but seems likely based on the patterns of tracks recorded during migration events of this species at both coasts.

Land-bird migration occurring during day- and night-time can be well described, and it appears that flight directions at the arrival coast are quite regular towards the expected migration direction. At the departure coasts these directions are quite variable, since birds follow the coastlines when conditions, e.g. winds blowing onshore, keep them from crossing, while during most other situations they start out to cross. Then, a concentration effect can be observed at the departure coast, while the birds are arriving more over a broad-front at the opposite coast.

4.4 Flight altitudes

The analysis of flight altitudes provides information about collision risks of migrating birds with man-made structures. The following chapter analyses flight altitudes registered during visual observations (4.4.1) and the vertical surveillance radar as well as fixed pencil beam radar (“Superfledermaus”) (4.4.2).

4.4.1 Flight altitude as registered by visual observations

Puttgarden onshore station

The overall distribution of flight altitudes already depicts a difference between spring and autumn, where in autumn a high proportion of birds were observed flying above 200 m altitude (Figure 4.65). The separation into waterbirds and other species reveals that waterbirds strongly prefer the low altitudes and show comparable altitude distributions in both seasons, whereas the other species, above all in autumn, were also registered in considerably high numbers above 200 m altitude (Figure 4.65, Figure 4.66).

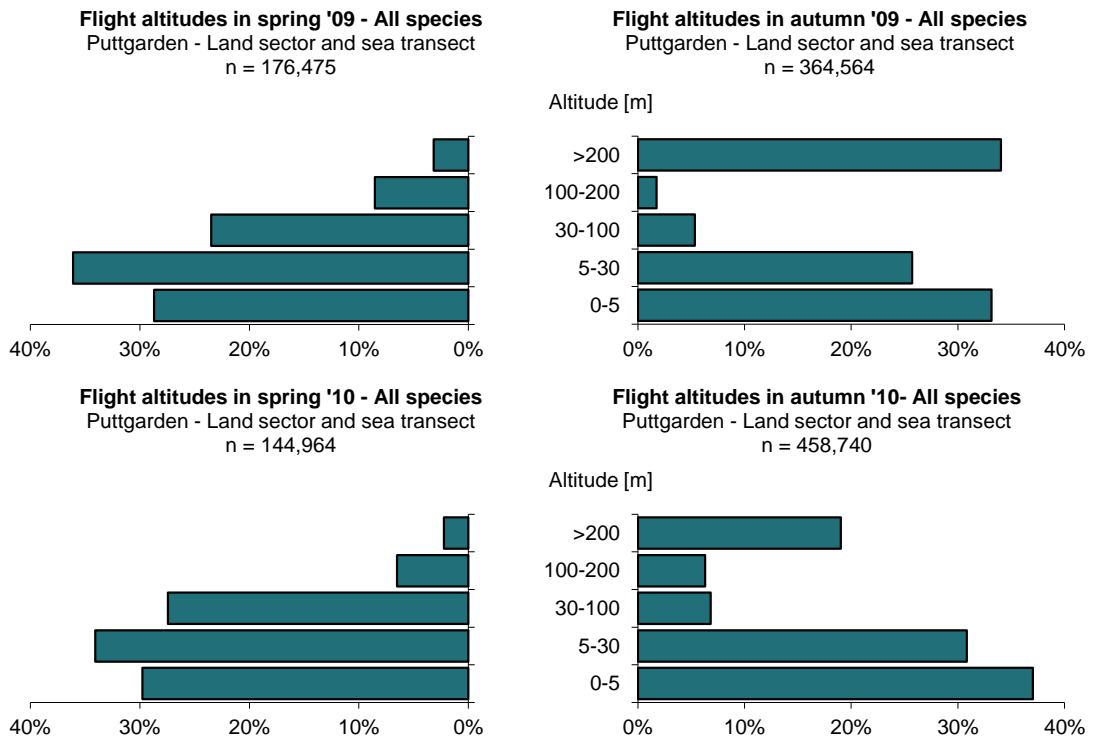

Figure 4.65 Daytime visual observations at Puttgarden onshore station: flight altitudes of all birds in spring (left) and autumn (right) 2009 (top) and 2010 (bottom).

FEHMARNBELT BIRDS

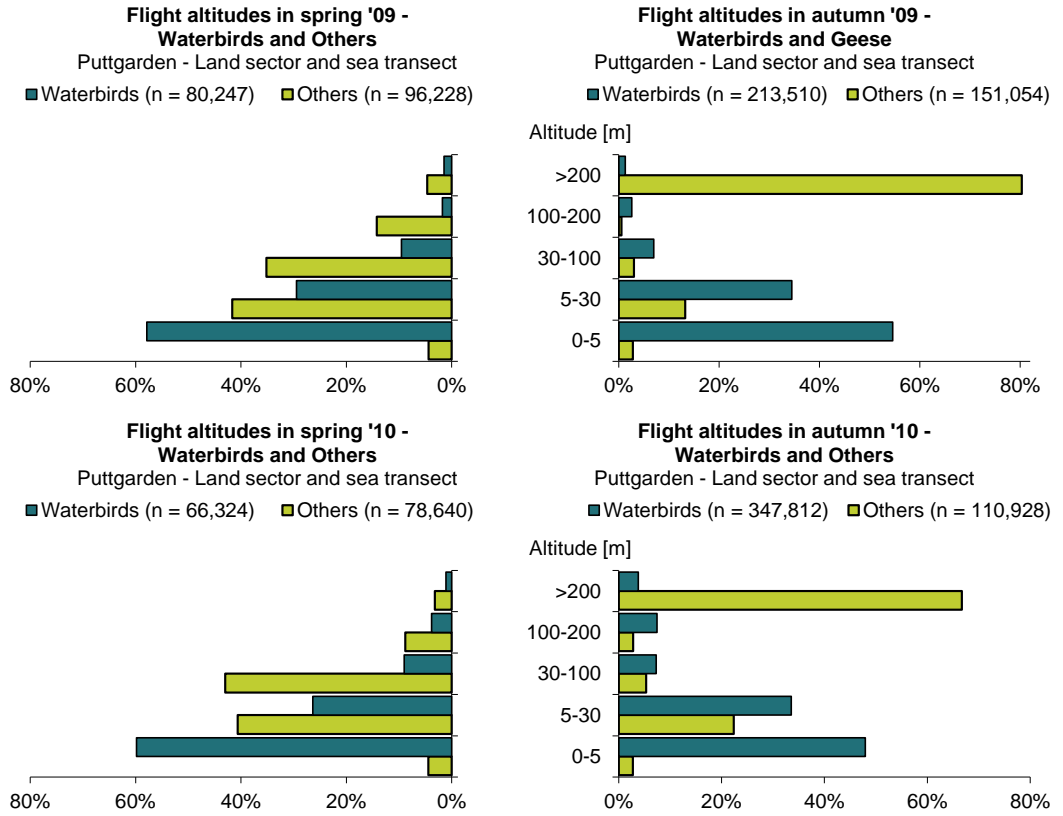

Figure 4.66 Daytime visual observations at Puttgarden onshore station: flight altitudes of all waterbird species (green bars) and other species (lime bars) in spring (left) and autumn (right) 2009 (top) and 2010 (bottom).

FEHMARNBELT BIRDS

The flight altitude distribution of pigeons indicates that this is the species group, which dominates the altitude band above 200 m especially during autumn (Figure 4.67). Here, large flocks have been observed. However, passerines can hardly be spotted beyond 100 m height, thus their altitude distribution as displayed in Figure 4.67 presumably is biased by visual detection availability.

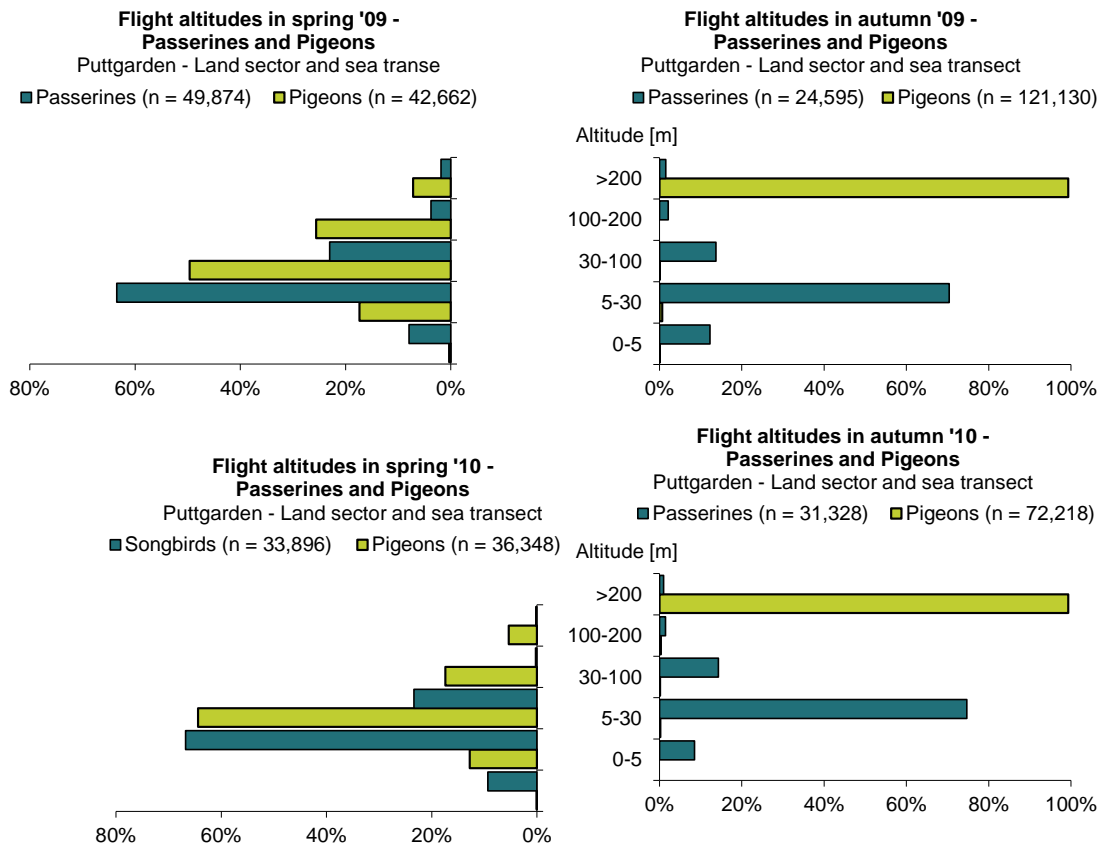

Figure 4.67 Daytime visual observations at Puttgarden onshore station: flight altitudes of passerines (purple bars) and pigeons (blue bars) in spring and autumn 2009 (left) and 2010 (right).

FEHMARNBELT BIRDS

Geese were observed more regularly distributed over the altitude bands, but seemed to occur mostly at medium altitudes. However, they were also recorded migrating close to the water surface and at higher altitudes (Figure 4.68). The same holds partly for birds of prey, with some species flying at low altitudes during active flights, whereas soaring species like Red Kite and Honey Buzzard were mostly found at higher altitudes. During autumn 2010, birds of prey were registered mostly in the two highest altitude bands above 100 m (Figure 4.68).

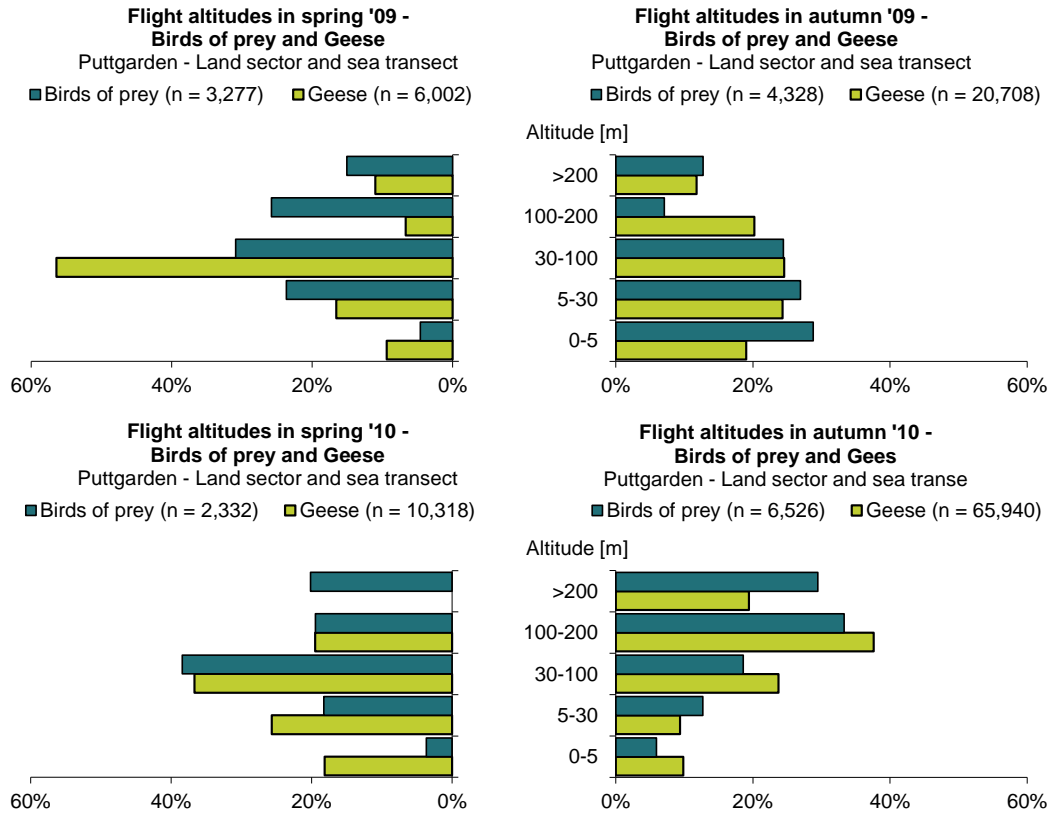

Figure 4.68 Daytime visual observations at Puttgarden onshore station: flight altitudes of birds of prey (green bars) and geese (lime bars) in spring (left) and autumn (right) 2009 (top) and 2010 (bottom).

FEHMARNBELT BIRDS

Rødbyhavn onshore station

Results from visual observations at Rødbyhavn onshore station are comparable to Puttgarden in most aspects (Figure 4.69, Figure 4.80). However, during autumn birds of prey were recorded to use higher altitudes at Rødbyhavn compared to Puttgarden (Figure 4.72), an expected difference between departure and receiving coast, where in autumn the birds are “gliding down” towards the coast of Fehmarn. Also, at Rødbyhavn pigeons frequently were observed flying at altitudes above 200 m, both during spring and autumn (Figure 4.71), whereas at Puttgarden pigeons were not observed to use these high altitudes during spring.

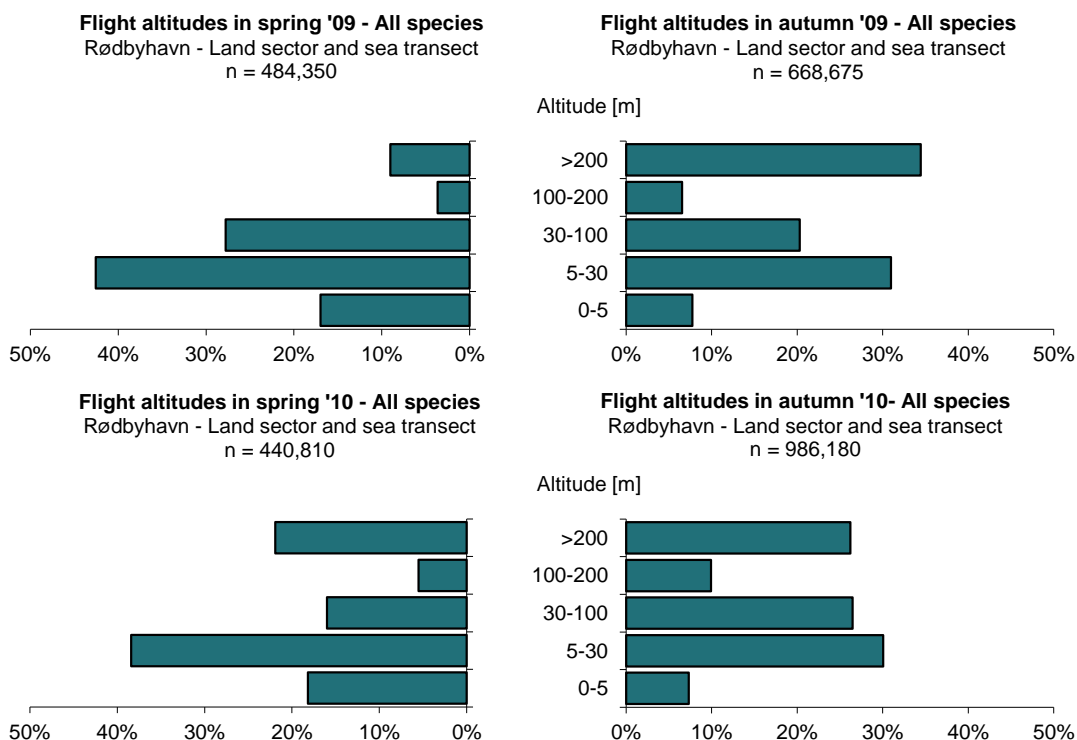

Figure 4.69 Daytime visual observations at Rødbyhavn onshore station: flight altitudes of all birds in spring (left) and autumn (right) 2009 (top) and 2010 (bottom).

FEHMARNBELT BIRDS

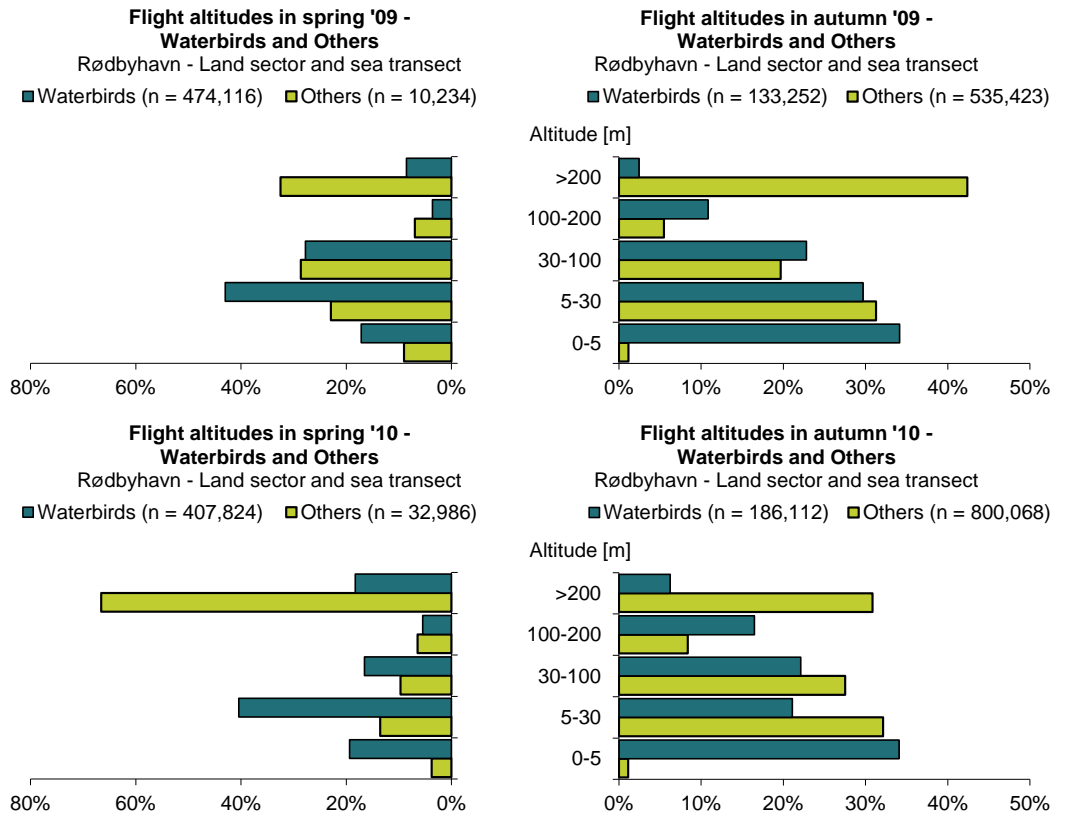

Figure 4.70 Daytime visual observations at Rødbyhavn onshore station: flight altitudes of all waterbird species (green bars) and other species (lime bars) in spring (left) and autumn (right) 2009 (top) and 2010 (bottom).

FEHMARNBELT BIRDS

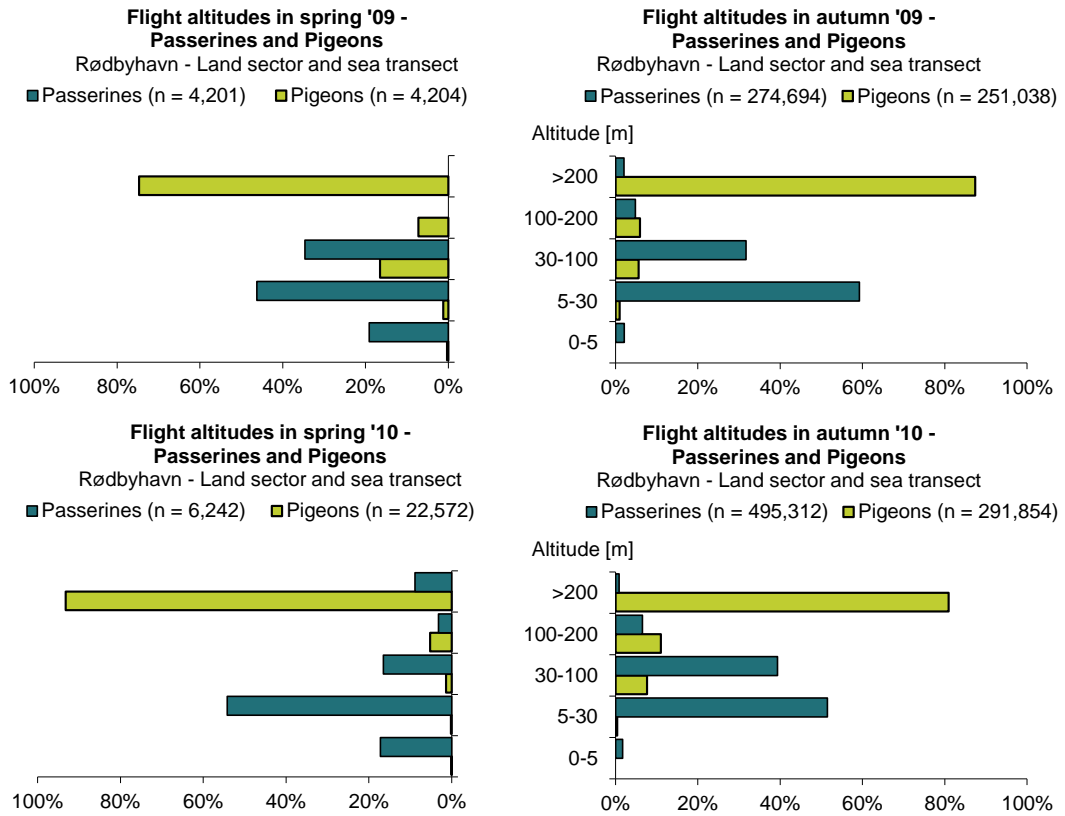

Figure 4.71 Daytime visual observations at Rødbyhavn onshore station: flight altitudes of passerines (green bars) and pigeons (lime bars) in spring (left) and autumn (right) 2009 (top) and 2010 (bottom).

FEHMARNBELT BIRDS

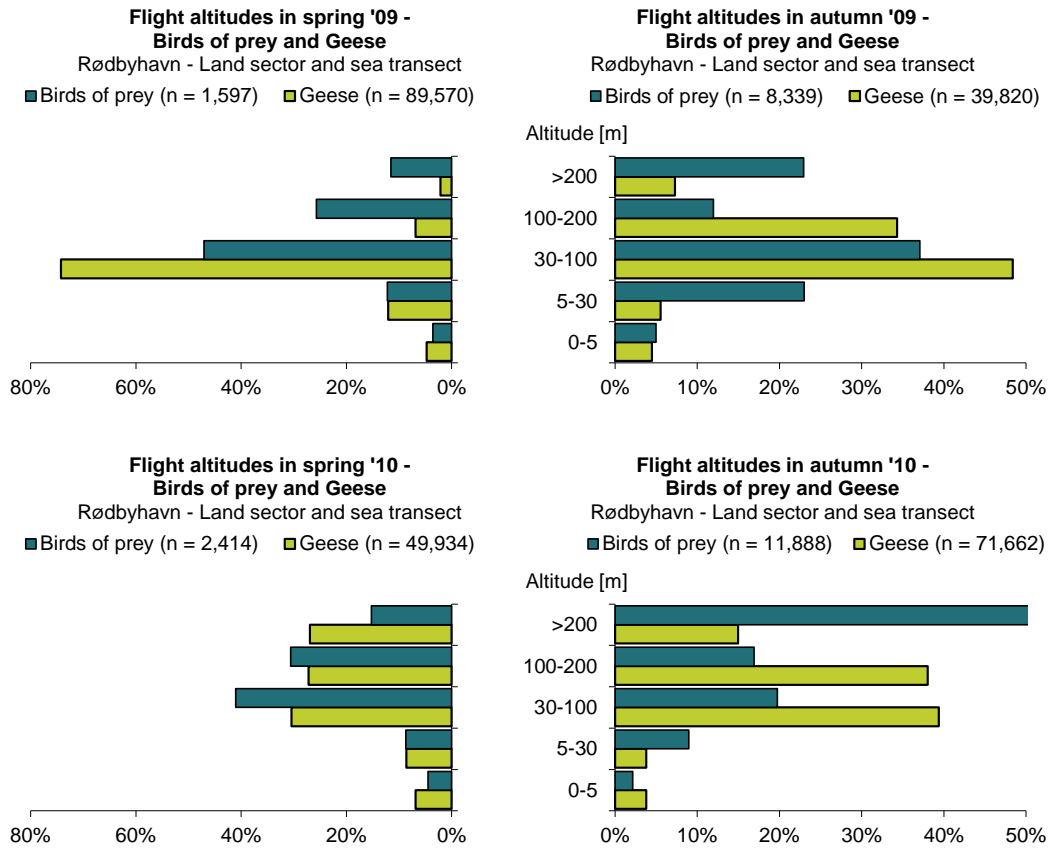

Figure 4.72 Daytime visual observations at Rødbyhavn onshore station: flight altitudes of birds of prey (green bars) and geese (lime bars) in spring (left) and autumn (right) 2009 (top) and 2010 (bottom).

FEHMARNBELT BIRDS

Fehmarnbelt offshore station

The flight altitude distributions as observed at the offshore location in the Fehmarnbelt depict a similar pattern to altitude distributions observed at the land stations (Figure 4.73 - Figure 4.76). However, during spring almost no birds have been detected above 100 m, with the exception of some single birds of prey (Figure 4.75). Most pigeons recorded at Puttgarden, but not at Rødbyhavn during spring, were not observed at the offshore station (Figure 4.76). During autumn, differences in altitude distributions between the offshore and the onshore stations at Puttgarden and Rødbyhavn were small.

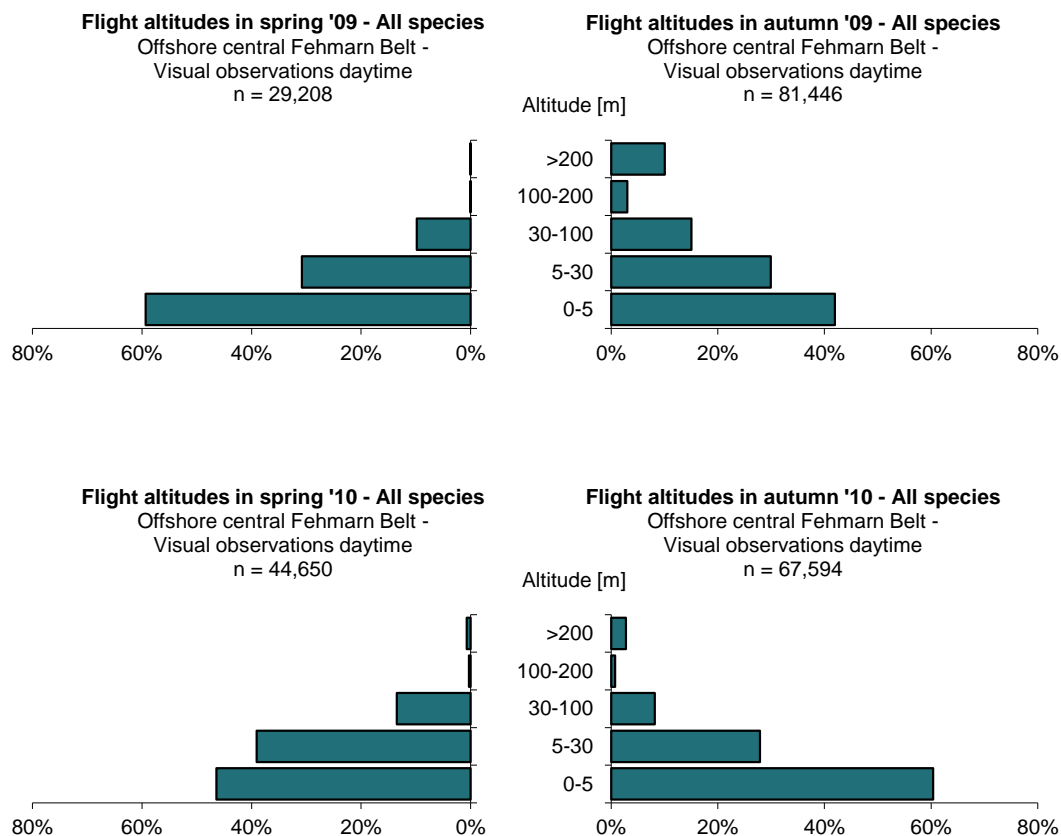

Figure 4.73 Daytime visual observations at Fehmarnbelt offshore station: flight altitudes of all birds in spring (left) and autumn (right) 2009 (top) and 2010 (bottom).

FEHMARNBELT BIRDS

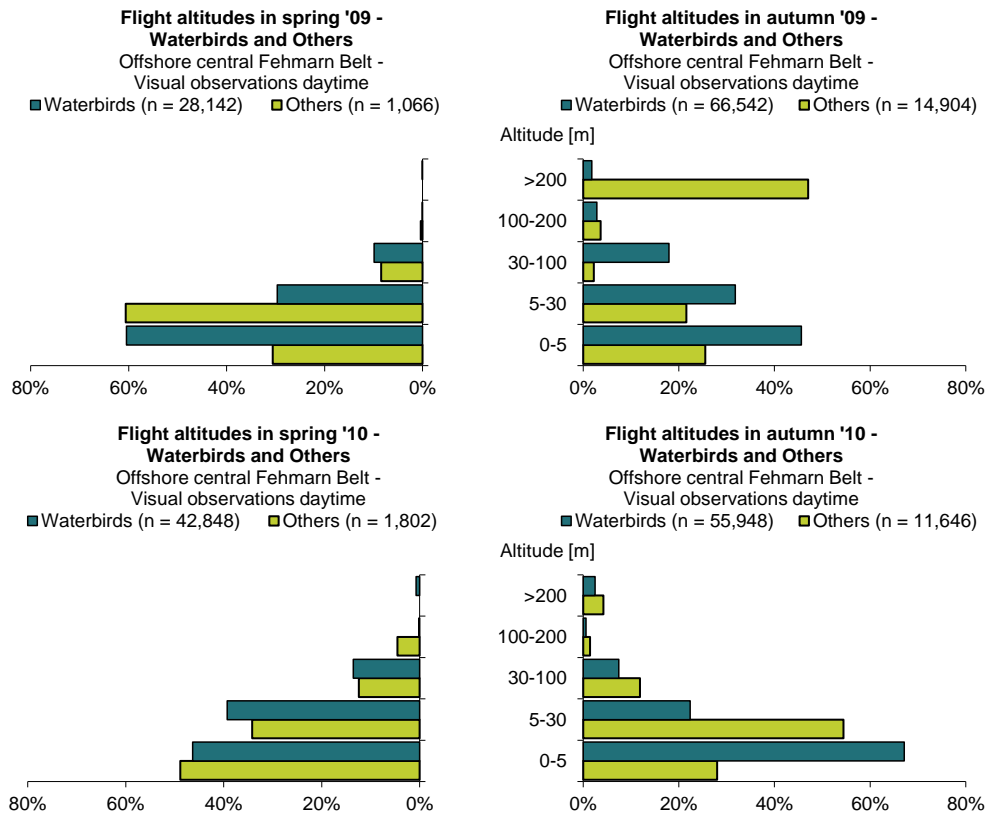

Figure 4.74 Daytime visual observations at Fehmarnbelt offshore station: flight altitudes of all waterbird species (green bars) and other species (lime bars) in spring (left) and autumn (right) 2009 (top) and 2010 (bottom).

FEHMARNBELT BIRDS

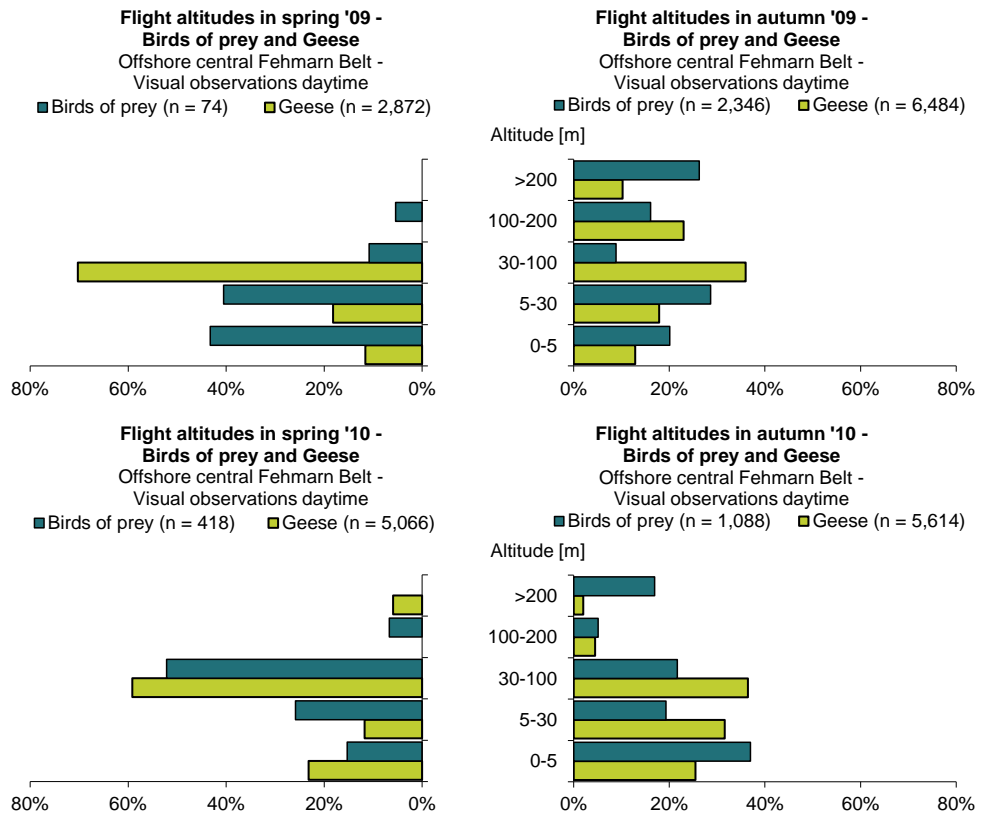

Figure 4.75 Daytime visual observations at Fehmarnbelt offshore station: flight altitudes of birds of prey (green bars) and geese (lime bars) in spring (left) and autumn (right) 2009 (top) and 2010 (bottom).

FEHMARNBELT BIRDS

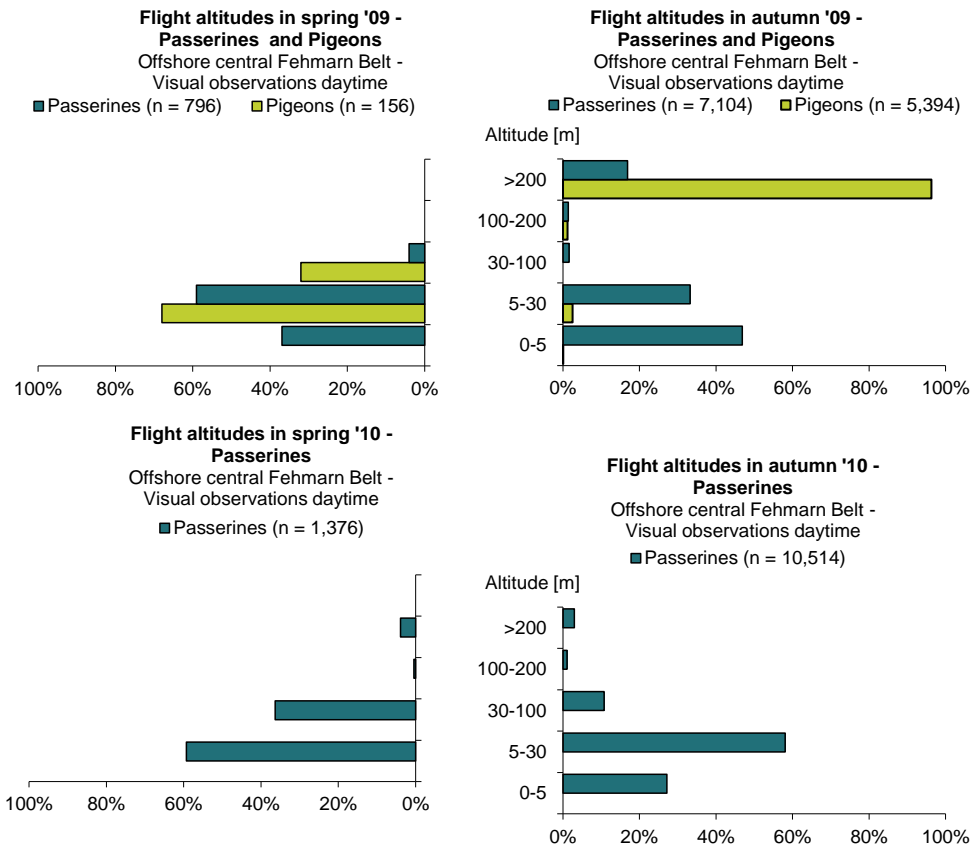

Figure 4.76 Daytime visual observations at Fehmarnbelt offshore station: flight altitudes of passerines (green bars) and pigeons (lime bars) in spring (left) and autumn (right) 2009 (top) and 2010 (bottom; no data on pigeons for 2010).

FEHMARNBELT BIRDS

Hyllekrog offshore station

The differences in flight altitudes at the Hyllekrog offshore station were found to be small compared to the flight altitudes recorded at the land stations or the Fehmarnbelt offshore station (see below) during autumn (Figure 4.77).

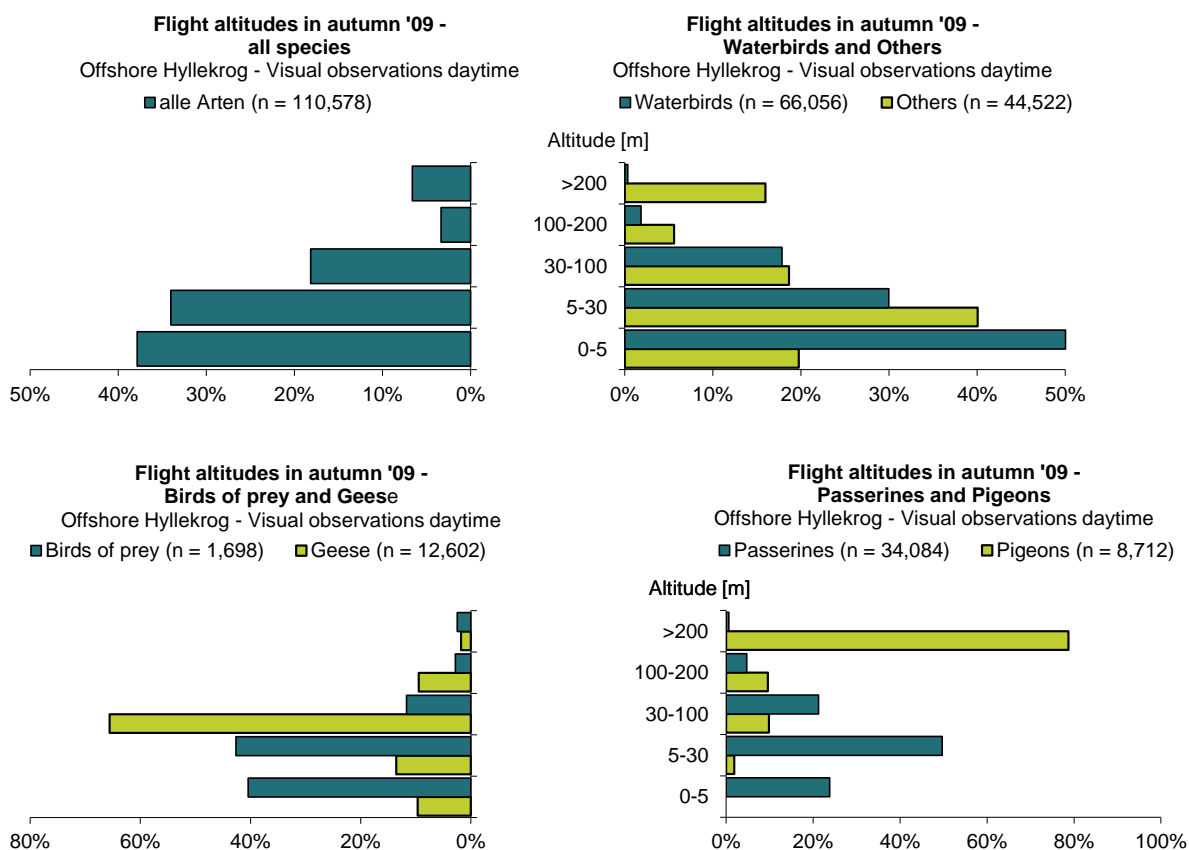

Figure 4.77 Daytime visual observations at Hyllekrog offshore station in autumn 2009: flight altitudes of selected species groups: all species (upper left), waterbirds and other (landbird) species (upper right), birds of prey and geese (lower left), and passerines and pigeons (lower right).

Summary

The flight altitudes registered by visual observations have only been separated into five altitude bands, since accurate estimates of flight altitude, without support by technical devices, are difficult particularly for birds flying higher than 100 m.

Overall altitude distributions during spring were comparable between the two land stations at Lolland and Fehmarn. At the offshore location in the Fehmarnbelt almost no birds were registered above 100 m in spring. During autumn a remarkable number of birds flying above 200 m were recorded at both land stations and also offshore, and these were identified as being mostly pigeons migrating in large flocks.

4.4.2 ***Flight altitude as registered by vertical surveillance radar and fixed pencil beam radar***

Altitude distributions as registered by visual observations were limited to the lower altitudes as small to medium species can hardly be detected beyond 100 m or large ones beyond 200 m. Furthermore, when birds or flocks are recognised at higher altitudes, exact height estimates are difficult. Vertical turned surveillance radar can measure altitude also of small to large sized birds and flocks up to 1,000 or even 1,500 m in good weather conditions. The Swiss 'Superfledermaus' delivers altitude distributions even up to 3,500 m.

The altitude distributions - separated for day- and night-time - as recorded by the fixed pencil beam during spring and autumn 2009 and 2010 as well as results from the vertical surveillance radars from 2010 are presented in the following. For the latter, figures are separated for the days or nights with highest migration intensities (10 peak days at onshore, 5 peak days at offshore stations) versus all other days or nights with lower migration intensities. In this way, the days and nights selected for high migration intensities represent less than 10 % of the effort and being compared with the other 90 % of the observation period.

2009 – Results from the fixed pencil beam radar

During spring 2009, quantitative measurements of flight altitudes as measured by the fixed pencil beam radar, migration intensity of diurnal and nocturnal migration was highest within the lowest 200 m, both for birds flying over the sea and those towards land, respectively (Figure 4.78). It must be noted here, that the fixed pencil beam measurements over the sea only involve the lowest 600 m, while the measurements towards land include all altitudes. This sampling design had been chosen, as for the measurements of the higher altitudes the beam points more or less overhead and thus will also cover birds flying over the sea.

During night-time, mean flight altitudes were higher than during the day and their distribution depicted a second peak at around 1,500 m. Within the lowest 700 m, altitude distributions were quite similar between those birds flying over sea and those flying towards land. However, during night-time migration intensities were higher at most altitudes, while during daytime the lowest altitude band contained most birds.

It is obvious that the overall altitude distribution is dominated by passerine-type birds. However, the altitudes of wader-type migration also included altitudes up to 1,000 m and above (Figure 4.79).

FEHMARNBELT BIRDS

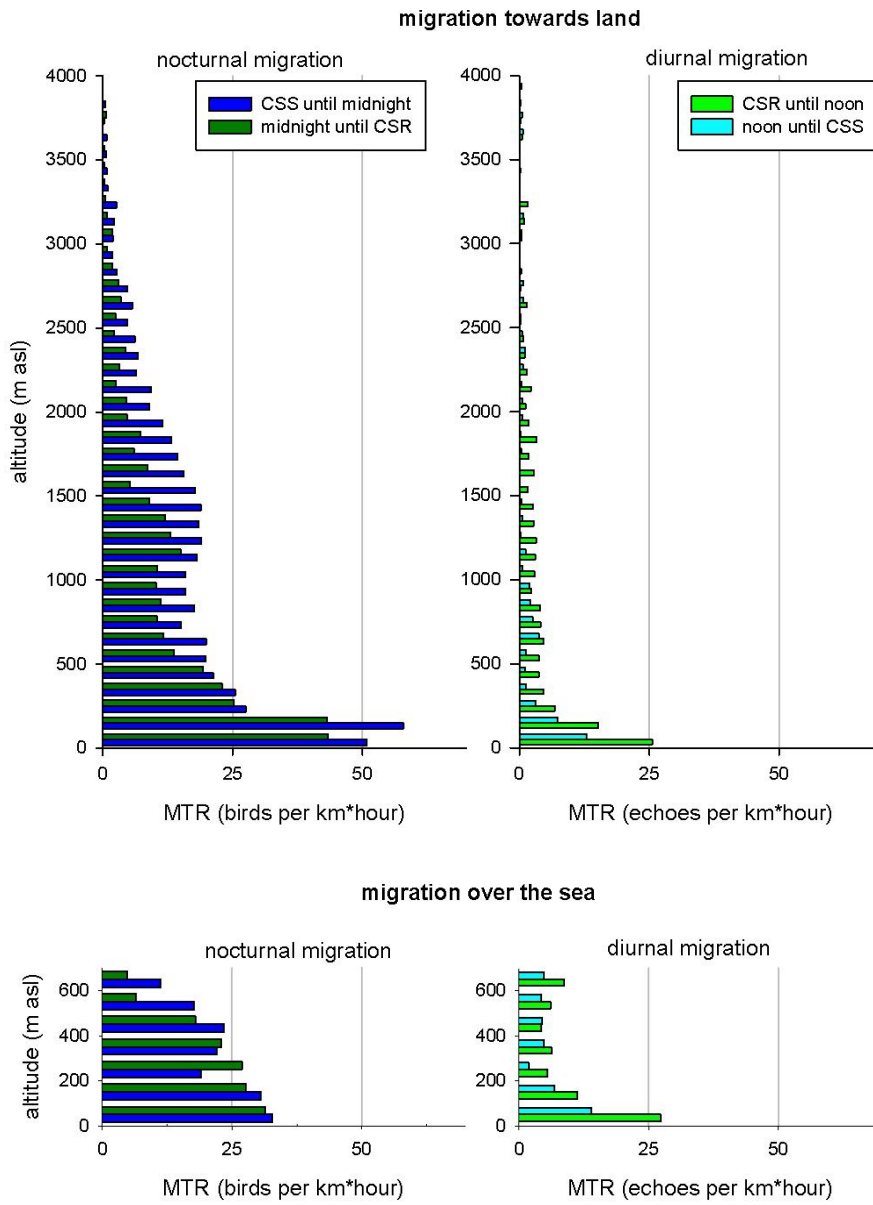

Figure 4.78 Spring 2009: height distribution of mean migratory traffic rate (MTR) of birds flying towards land (above) and over sea (below). Four time intervals are given - civil twilight at sunset (CSS) until midnight - midnight until civil twilight at sunrise (CSR) - CSR until noon - noon until CSS.

FEHMARNBELT BIRDS

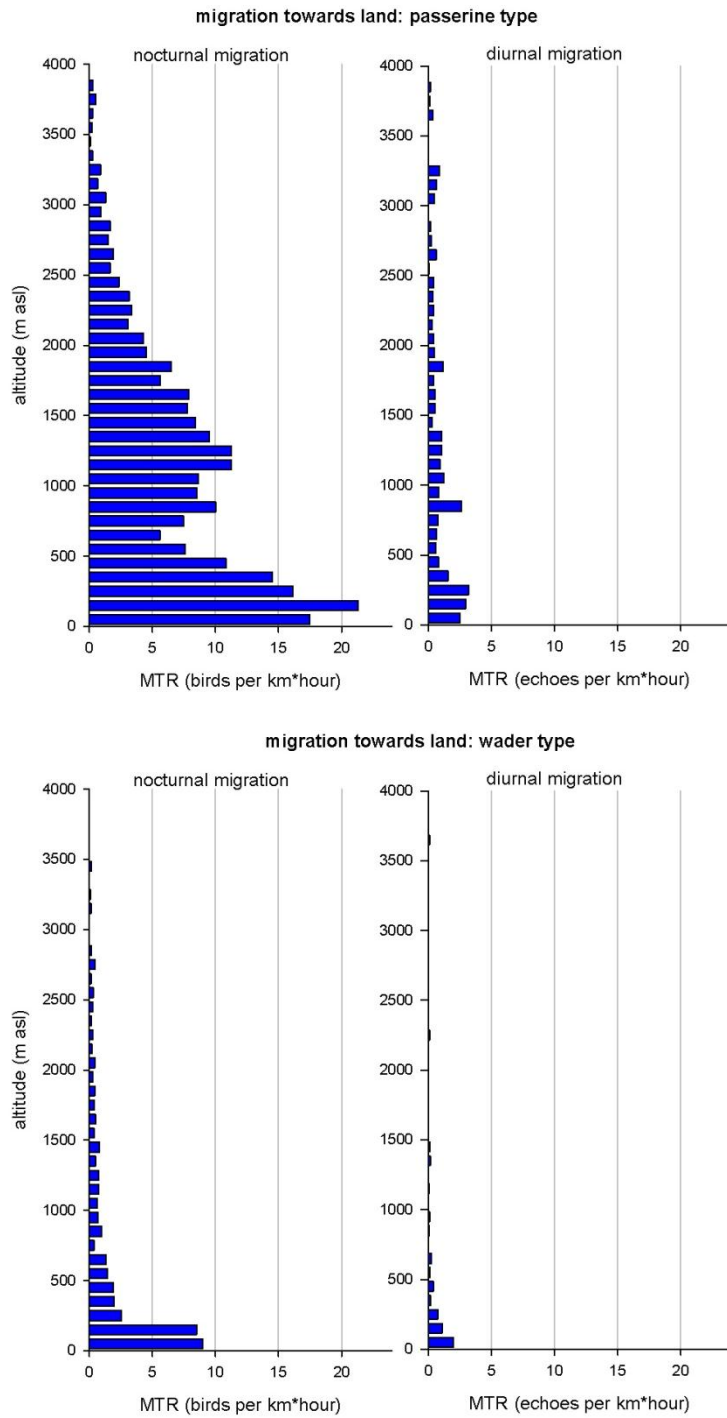

Figure 4.79 Spring 2009: height distribution of mean migratory traffic rate (MTR) of passerine-type (top) and wader-type (bottom) birds flying towards land.

FEHMARNBELT BIRDS

During autumn 2009, night-time flight altitudes of tracks were mainly (51 %) recorded above 500 m. During daytime, 25 % of the tracks were below 200 m, which is a smaller proportion than observed e.g. during spring, when large numbers of seaducks contributed to the fraction flying at low altitudes (Figure 4.80).

Again, passerines dominated the altitude distributions. Wader-type birds showed a remarkable peak around 800 m altitude (Figure 4.81).

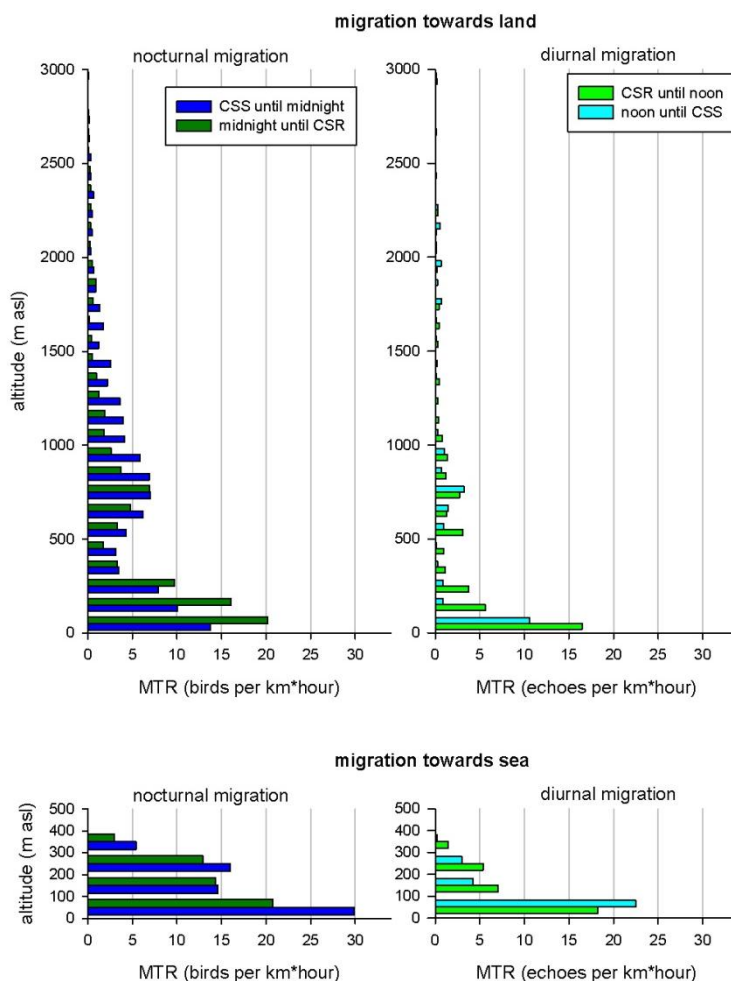

Figure 4.80 Autumn 2009: height distribution of mean migratory traffic rate (MTR) of birds flying towards land (above) and over sea (below). Four time intervals are given - civil twilight at sunset (CSS) until midnight - midnight until civil twilight at sunrise (CSR) - CSR until noon - noon until CSS. Be aware of different scales on the X-axis.

FEHMARNBELT BIRDS

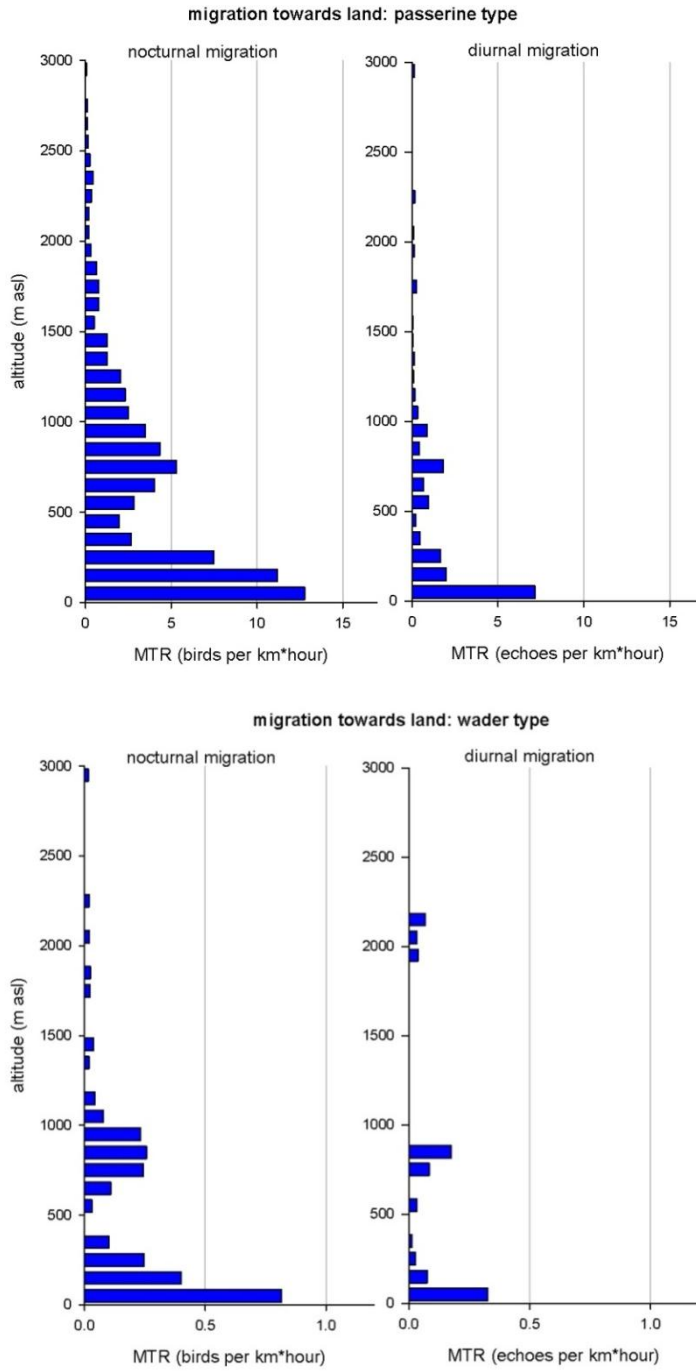

Figure 4.81 Autumn 2009: height distribution of mean migratory traffic rate (MTR) of passerine-type (top) and wader-type (bottom) birds flying towards land.

2010 – Results from the surveillance radars and the fixed pencil beam radar

It must be noted, that both during day- and night-time, migration intensities in the lowest altitude band are most likely considerably underestimated due to the known weakness of vertical surveillance radars to correctly measure in this altitude band (e.g. Wendeln et al. 2007, Schmaljohann 2008). As this is most obvious at the land stations Rødbyhavn and Westermønsø, shading by local structures may play an additional role.

Consequently, the migration intensities below 200 m may be generally too low everywhere in the following figures.

During spring 2010, daytime altitude distributions as recorded by the different radar stations were comparable. At days with high migration intensities recorded flight altitudes were rather evenly distributed among all altitude bands with low values < 100 m, while during days with lower migration intensities the lower altitudes were more pronounced (Figure 4.82). It is likely, that low altitudes are dominated by short-distance movements during overall low migration intensities, while during periods of high migration intensities, higher altitudes are more frequented, and thus short-distance movements are less visible in the results.

FEHMARNBELT BIRDS

Rødbyhavn, Lolland

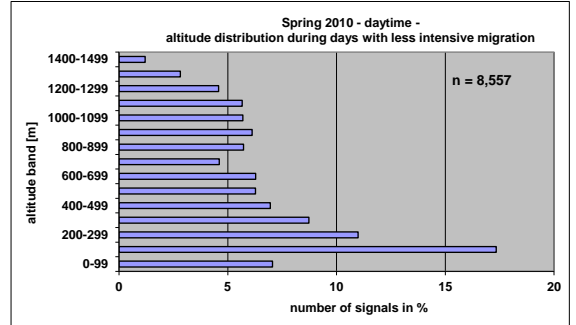
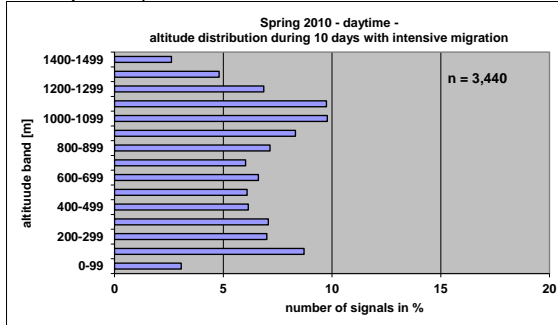

Offshore Fehmarnbelt

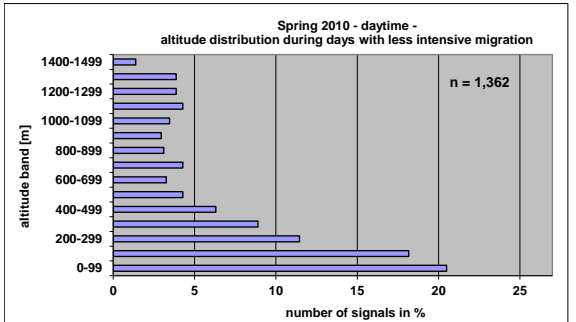
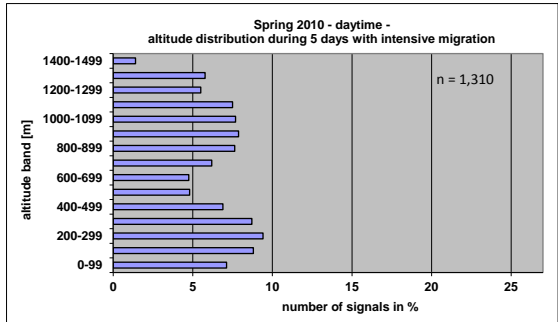

Puttgarden, Fehmarn

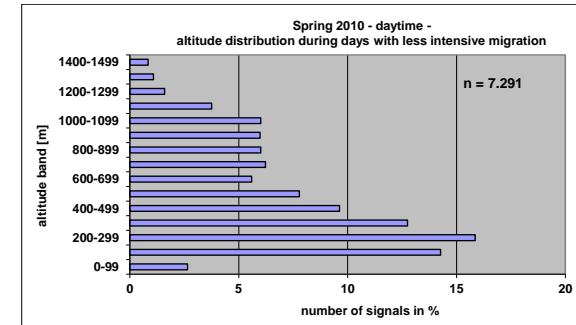
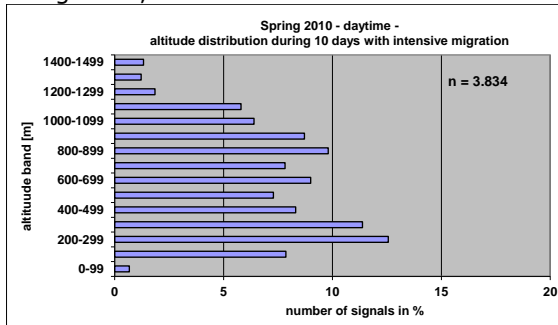

Westermarkelsdorf, Fehmarn

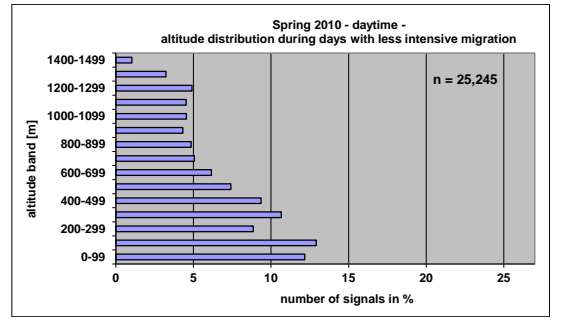
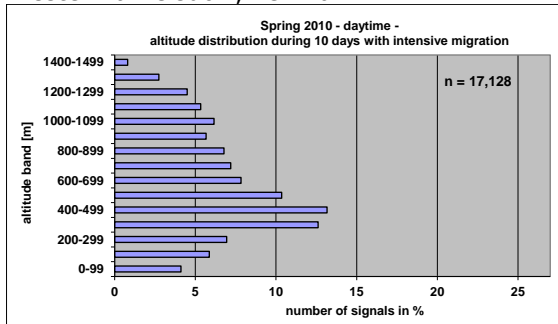
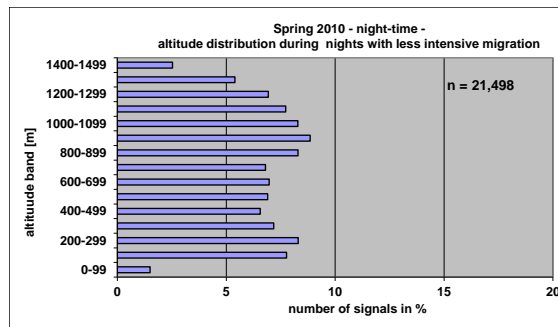
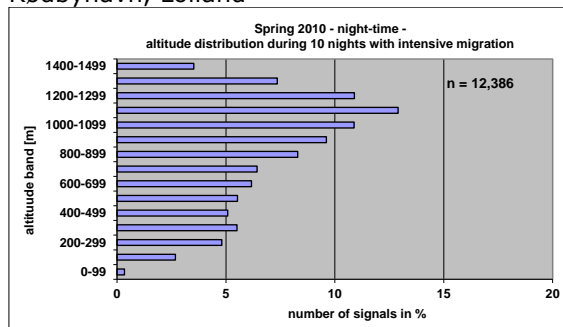

Figure 4.82 Altitude distributions measured by surveillance radar at four radar stations in spring 2010 – daytime. Days with high migration intensities (left) versus days with low migration intensities (right).

FEHMARNBELT BIRDS

Altitude distributions during night-time in spring 2010 for those nights with intensive migration show a remarkable pattern at the offshore station in the Fehmarnbelt and at Rødbyhavn on Lolland (Figure 4.83). Here, the altitudes above 800 m were observed to represent a considerable proportion of the recorded signals.

Rødbyhavn, Lolland



Offshore Fehmarnbelt

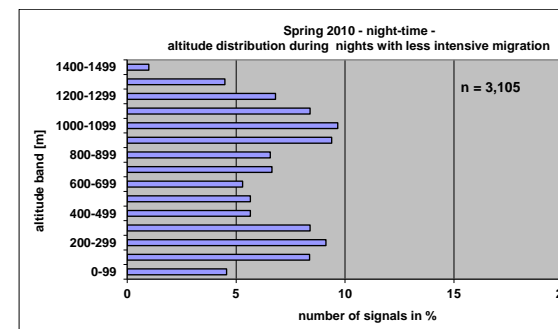
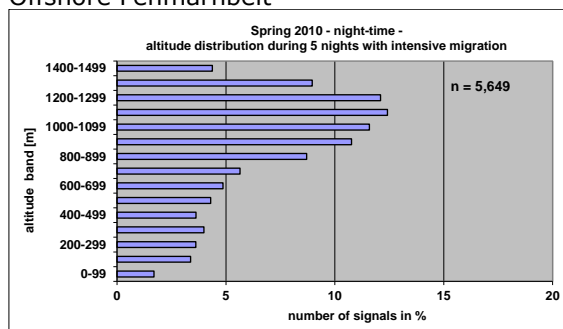

Puttgarden, Fehmarn

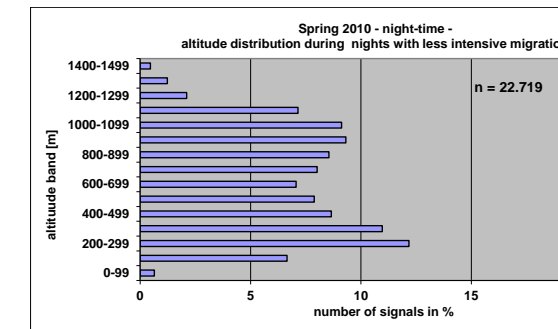
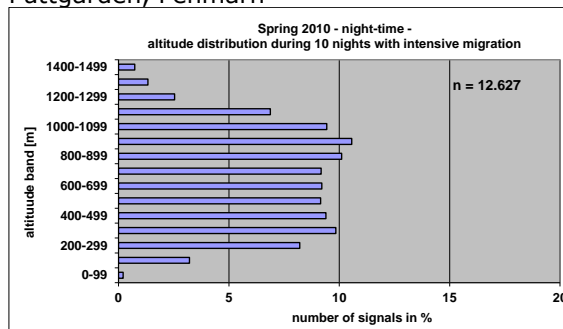

Westermarkelsdorf, Fehmarn

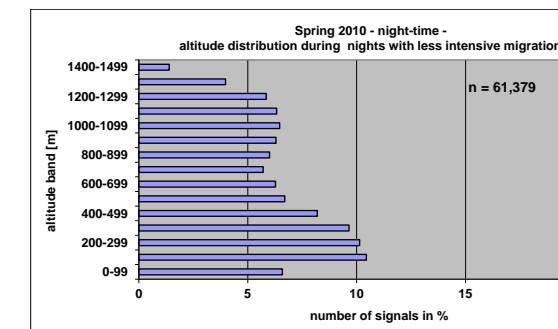
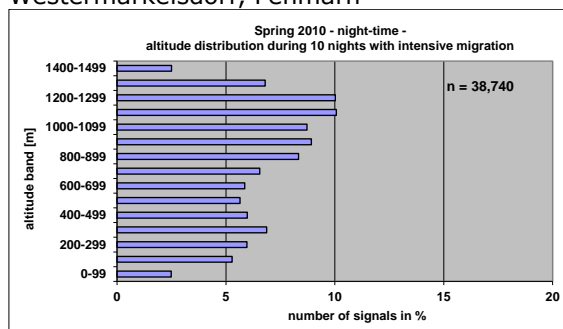

Figure 4.83 Altitude distributions measured by surveillance radar at four radar stations in spring 2010 – night-time. Nights with high migration intensities (left) versus days with low migration intensities (right).

FEHMARNBELT BIRDS

This pattern was also observed at the Westermarkelsdorf station, even though less distinct, while results of the Puttgarden station do not confirm this pattern. During times of lower migration intensities no dominance of high flight altitudes could be detected, but are more or less regular with some proportions of the signals in the lower altitudes (100-300 m), except for Lolland (Figure 4.83).

Measurements by the fixed pencil beam radar resulted in a flight height distribution pattern which did not differ from the measurements at the Danish coast in 2009. Highest migration intensities were observed between 100 and 200 m during nocturnal migration and within the lowest 100 m height interval during diurnal migration. Flight altitudes also occurred above 500 m up to 1,500 m; however, in overall low migration intensities. Intensities are higher during night-time compared to daytime (Figure 4.84).

Looking at the altitude distribution of the 'passerine-type' signals, a more pronounced shift to higher altitudes can be observed during night-time, while the wader-type birds occurred with higher proportions below 300 m (Figure 4.85).

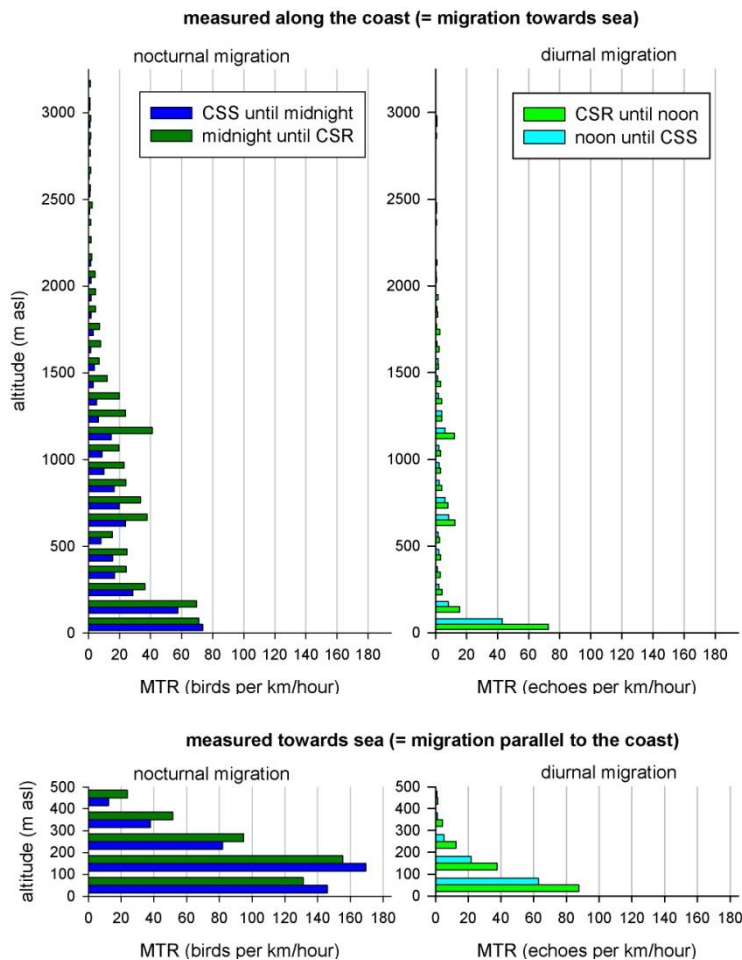

Figure 4.84 Height distribution of mean migration traffic rate (MTR) of birds flying towards sea (above) and parallel to the coast (below). Four time periods are given - civil twilight at sunset (CSS) until midnight – midnight until civil twilight at sunrise (CSR) – CSR until noon – noon until CSS.

FEHMARNBELT BIRDS

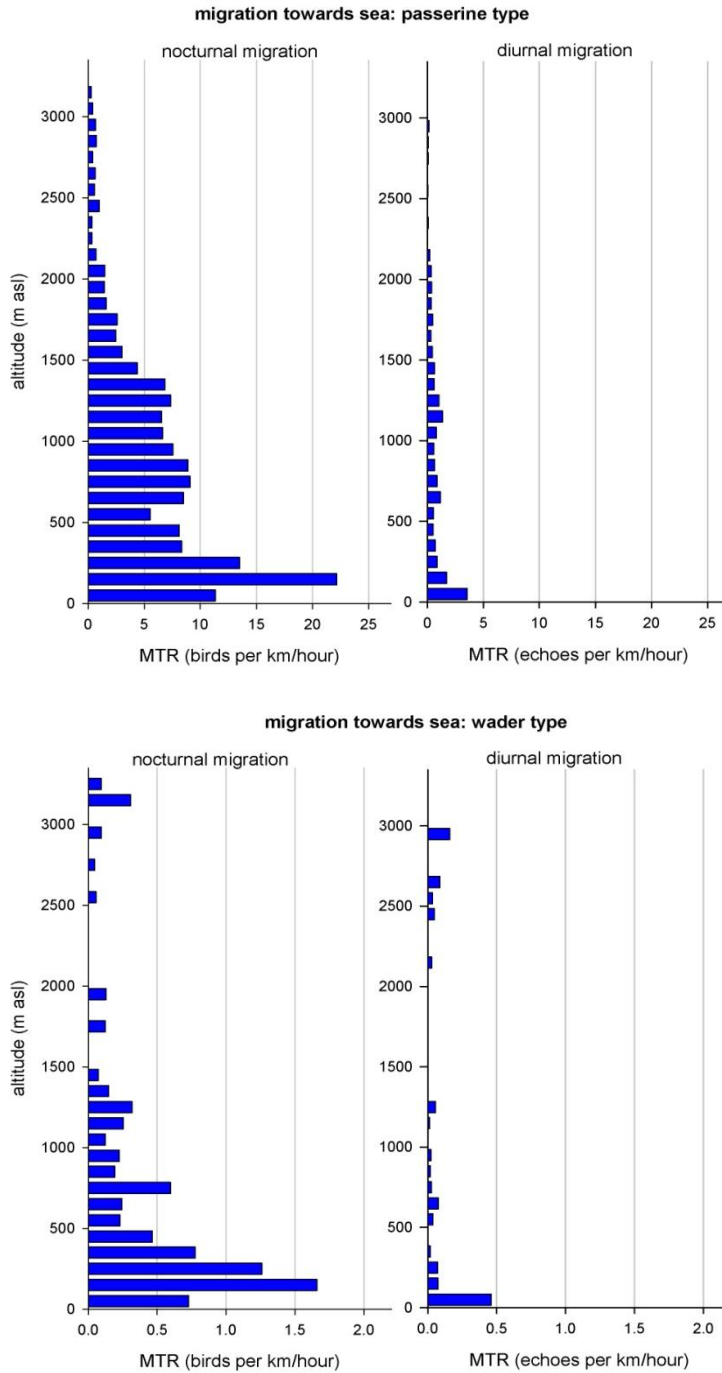
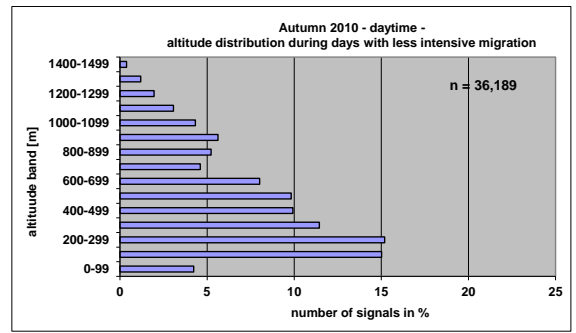
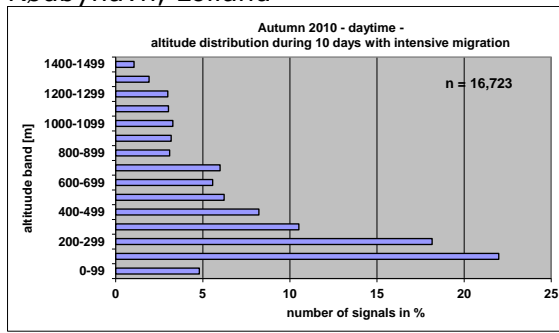

Figure 4.85 Height distribution of mean migration traffic rates (MTR) for the passerine-type (top) and wader-type (bottom) of birds flying towards the sea.

Daytime migration as observed during autumn 2010 depicts a high proportion of low altitude migration at Lolland for all migration intensities, and at Puttgarden for times of low migration intensity (Figure 4.86). Also, for Lolland and Westermørkeldsdorf in general almost no differences between times of low and high migration intensities could be detected. In contrast, at the offshore station as well as at Puttgarden onshore station higher altitudes were observed more frequently during days with high migration intensities higher than during days with low migration intensities (Figure 4.86).

FEHMARNBELT BIRDS

Rødbyhavn, Lolland



Offshore Fehmarnbelt

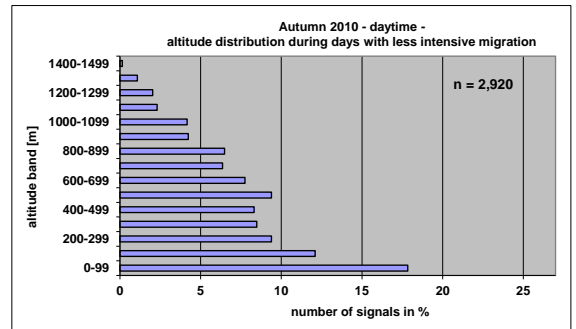
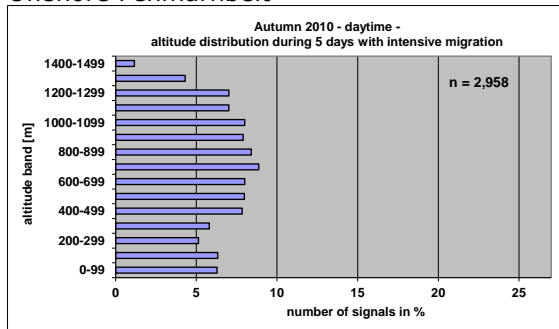

Puttgarden, Fehmarn

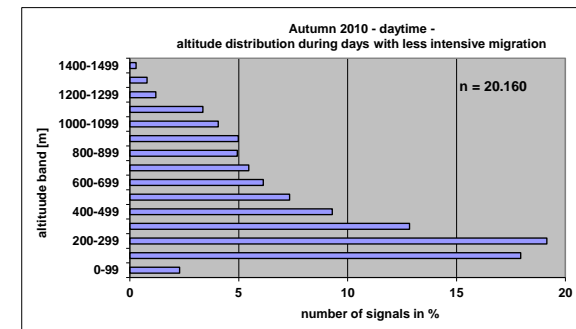
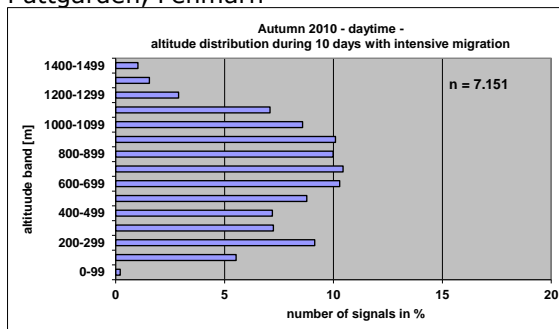

Westermarkelsdorf, Fehmarn

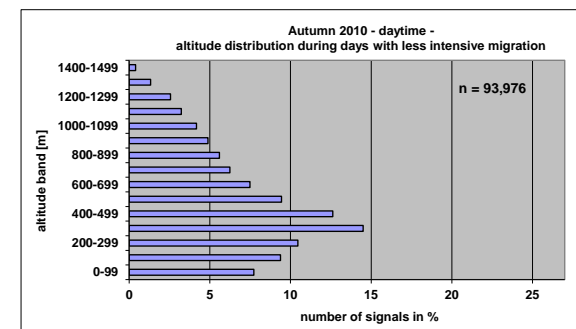
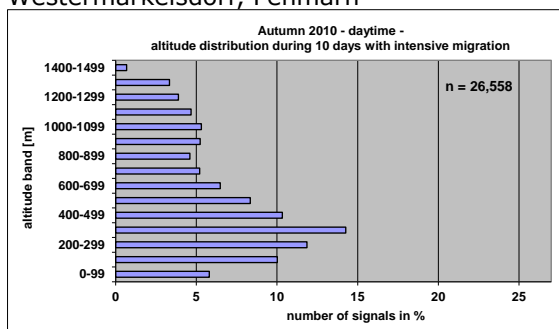
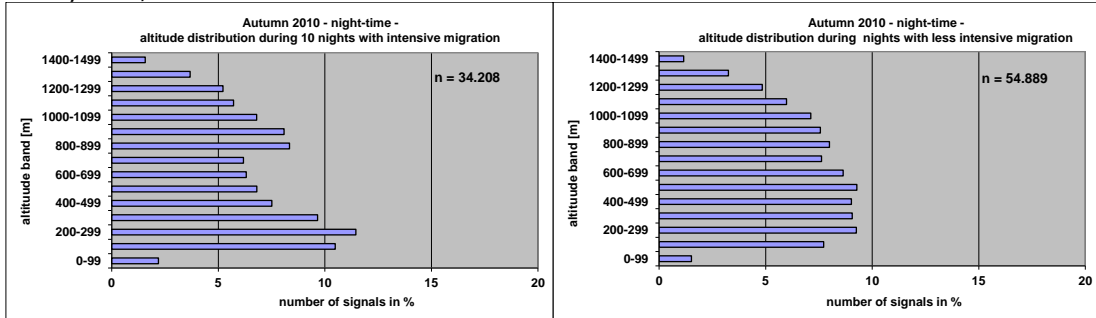

Figure 4.86 Altitude distributions measured by surveillance radar at four radar stations in autumn 2010 – daytime. Days with high migration intensities (left) versus days with low migration intensities (right).

FEHMARNBELT BIRDS

For night-time migration in autumn 2010 differences in flight altitude patterns between stations and between nights with high or low migration intensities were observed to be small (Figure 4.87). This may be due to the overall high migration volumes during autumn nights, masking or overriding single peculiar altitude distributions.

Rødbyhavn, Lolland



Offshore Fehmarnbelt

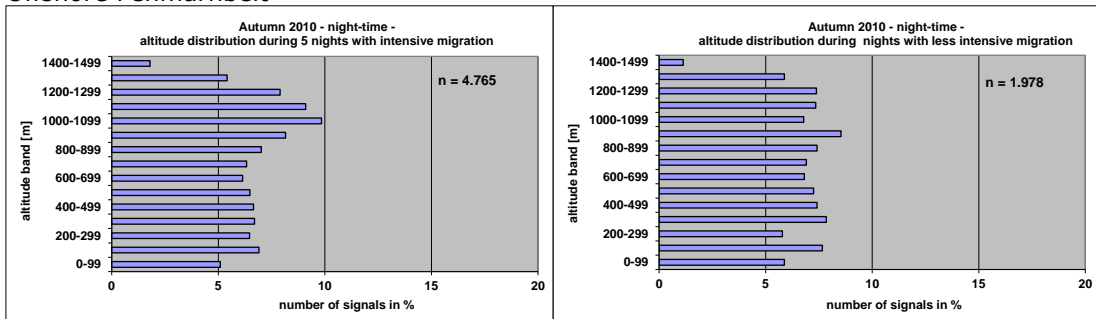

Puttgarden, Fehmarn

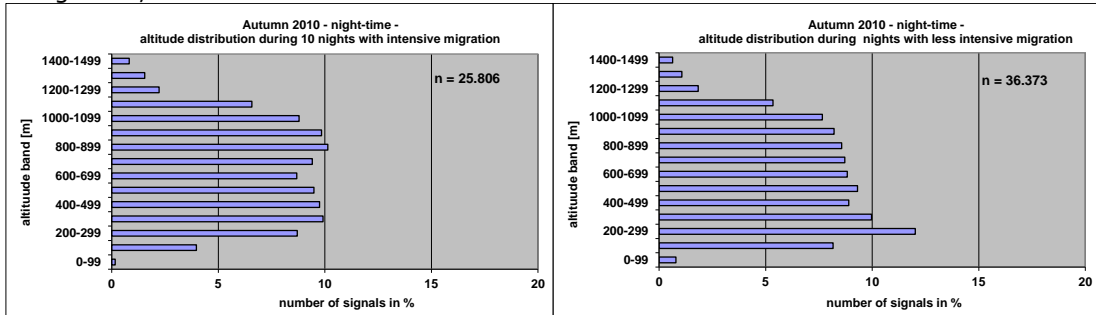

Westermarkelsdorf, Fehmarn

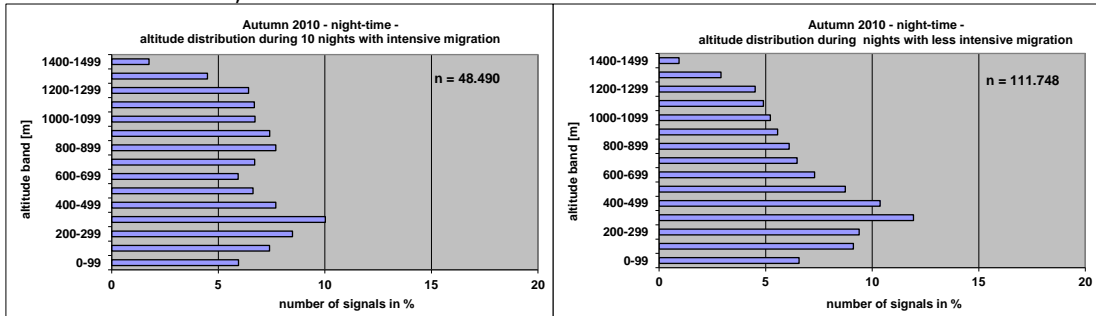

Figure 4.87 Altitude distributions measured by surveillance radar at the four radar stations in autumn 2010 – night-time. Nights with high migration intensities (left) versus days with low migration intensities (right).

FEHMARNBELT BIRDS

However, measurements by the fixed pencil beam along the coast (i.e. birds crossing the Fehmarnbelt) showed that the intensity of nocturnal migration and diurnal migration was highest in the height interval between 1,000 and 1,500 m. For the measurements towards the sea (i.e. recording birds flying parallel to the coastline), the highest migration intensities occurred between 200 and 300 m for nocturnal migrants and below 200 m for diurnal migrants (Figure 4.88). It must be noted, that there is a potential underestimation of low altitudes at Puttgarden, as at this location measurements at low heights were frequently disturbed by clutter.

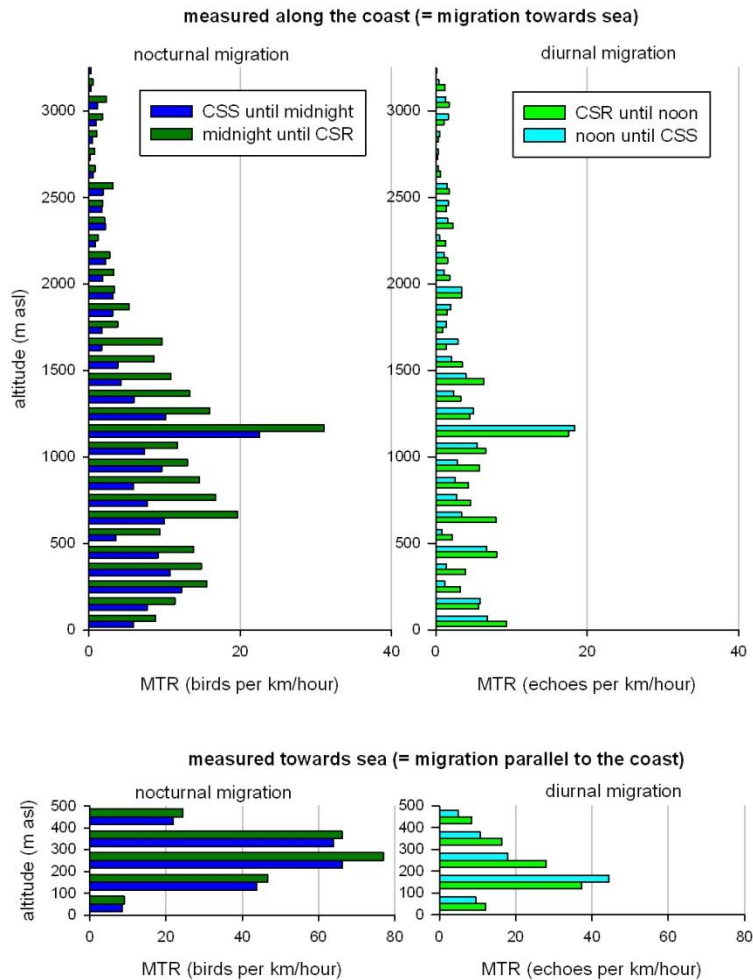

Figure 4.88 Height distribution of mean migration traffic rate (MTR) of birds flying towards sea (above) and parallel to the coast (below). Four time periods are given - civil twilight at sunset (CSS) until midnight - midnight until civil twilight at sunrise (CSR) - CSR until noon - noon until CSS.

FEHMARNBELT BIRDS

Flight altitudes of passerine-type birds were on average lower than those for all signals (Figure 4.89).

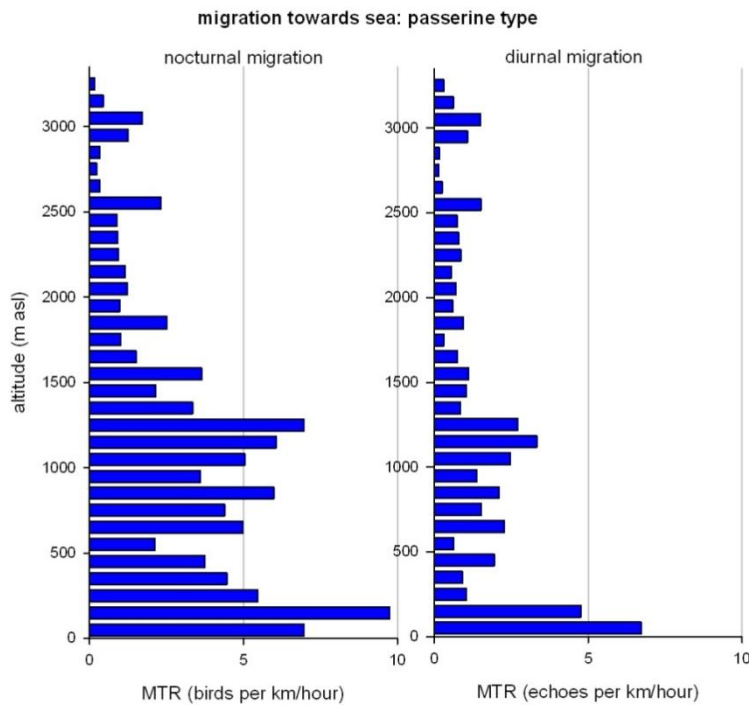
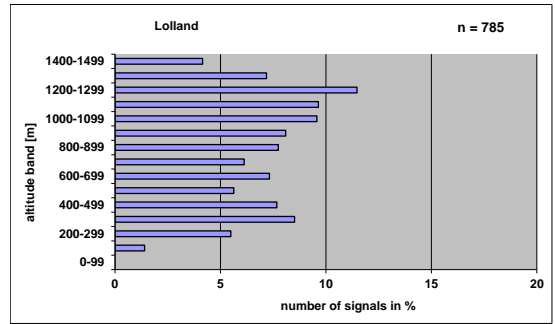
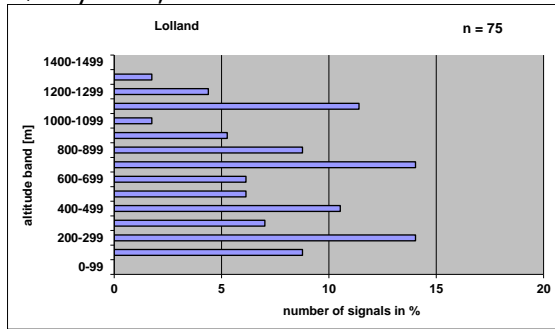

Figure 4.89 Height distribution of mean migration traffic rates (MTR) for the passerine-type of birds (N=61,375) flying towards the sea.

A look at some particular migration events is intended to shed some more light on these issues and potential differences. As mentioned in chapter 4.2.2, on April 5, 2010 high migration intensities were recorded at Fehmarn only, while the day after on April 6 high intensities were observed at all stations. It appears that the migration on April 5 took place predominantly at altitudes < 900 m, recorded at both Fehmarn locations, Puttgarden and Westermarkelsdorf (Figure 4.90). The main migration direction was ESE, which indicates birds flying along the Fehmarnbelt and not passing Lolland. Wind speed was low from westerly directions. For the migration event on April 6, migration intensities and altitude profiles are comparable among all investigated stations (Figure 4.90). The common flight directions towards NE indicate that birds were crossing the Fehmarnbelt and therefore passing both Fehmarn and Lolland during a wind speed of 5 m/sec from ESE.

FEHMARNBELT BIRDS

Rødbyhavn, Lolland



Puttgarden, Fehmarn

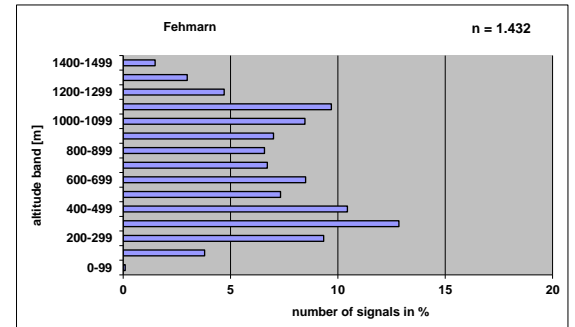
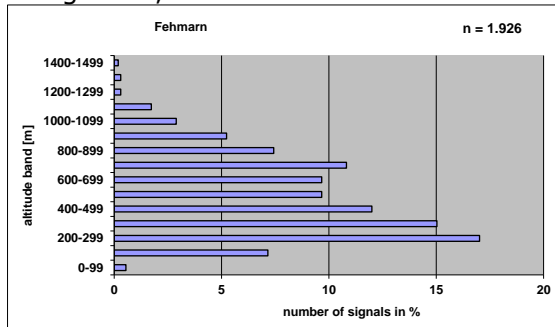

Westermarkelsdorf, Fehmarn

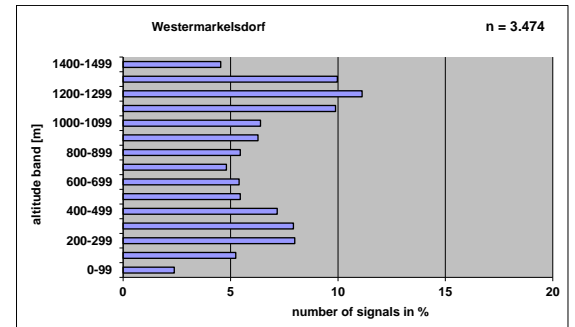
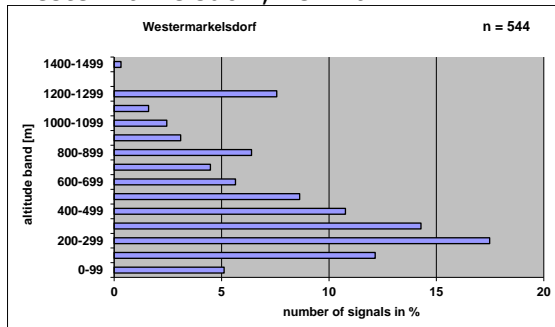
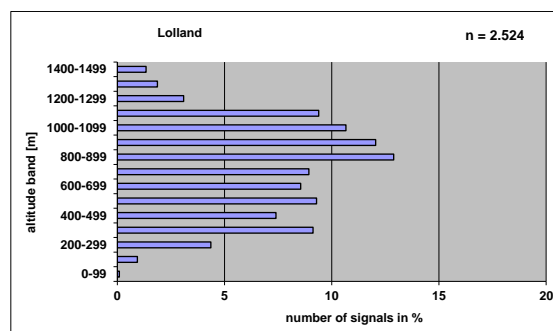
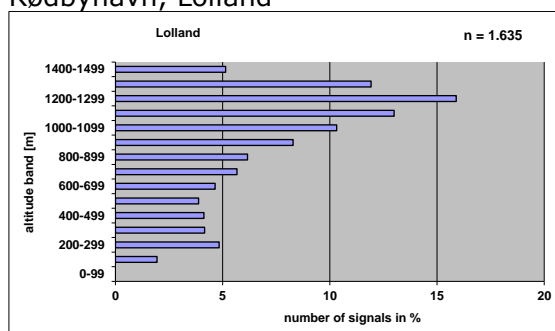

Figure 4.90 Altitude distributions night-time measured by surveillance radar in Rødbyhavn (top), Puttgarden (middle) and Westermarkelsdorf (bottom) on April 5, 2010 (left) and April 6, 2010 (right).

On April 24, 2010, migration at high altitude bands was registered at all stations except Puttgarden (Figure 4.91). At this day wind was ESE with 5 m/sec, thus crosswinds for expected migration directions. During April 25, the peak migration day in spring 2010, altitude distributions cumulated at altitudes around 800 m, also confirmed by data from the fixed pencil beam radar. Wind speed was low from SSE at this day.

FEHMARNBELT BIRDS

Rødbyhavn, Lolland



Offshore Fehmarnbelt

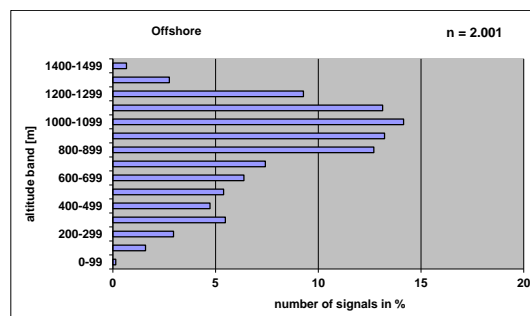
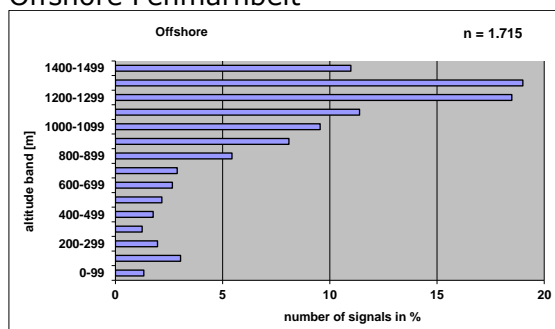

Puttgarden, Fehmarn

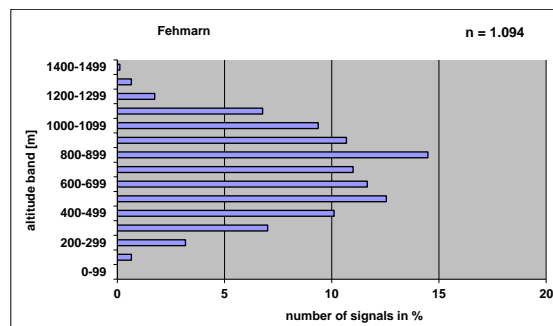
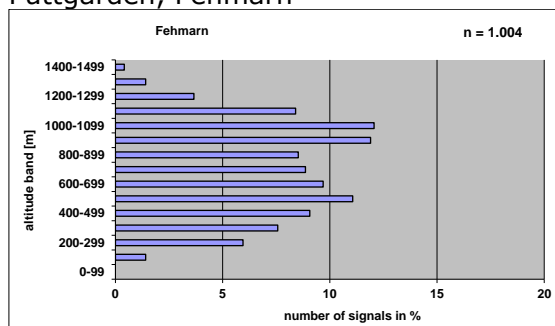

Westermarkelsdorf, Fehmarn

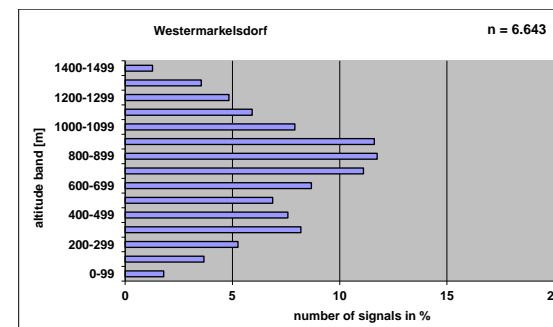
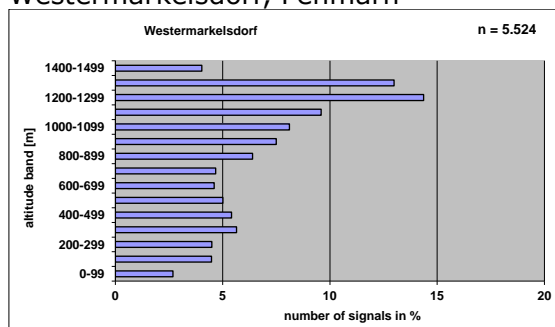

Figure 4.91 Altitude distributions night-time measured by surveillance radar in Rødbyhavn, offshore Fehmarnbelt, Puttgarden and Westermarkelsdorf (from top to bottom) on April 24, 2010 (left) and April 25, 2010 (right).

An autumn migration event was recorded on October 8-10, 2010. On October 8, strong wind blew from W with 13 m/sec, thus head- or crosswind for expected migration directions. Migration intensity was low at Puttgarden, while both at NW

FEHMARN BELT BIRDS

Fehmarn (Westermarkelsdorf) and Lolland medium to high intensity prevailed at low altitudes with main flight direction towards SW (Figure 4.92).

In the night of October 9 the wind had turned towards ESE and slowed down. Migration picked up at all stations, still with lowest intensities at Puttgarden. Migration was still concentrated at lower altitudes, but higher flight altitudes were now also represented, and the fixed pencil beam radar showed even migration occurring above 1,500 m. Migration directions were S at Lolland and SW at Puttgarden and acoustic observations registered thrushes and Robin.

During the following night, October 10, wind turned towards E and increased somewhat. Migration intensities were recorded to be very high at all stations, flying altitudes were regularly distributed and obtained altitude profiles are comparable to fixed pencil beam results. Migration directions were clearly SSW. Acoustic results revealed high intensities of thrushes, Robin and also Barnacle Goose migration.

Rødbyhavn, Lolland

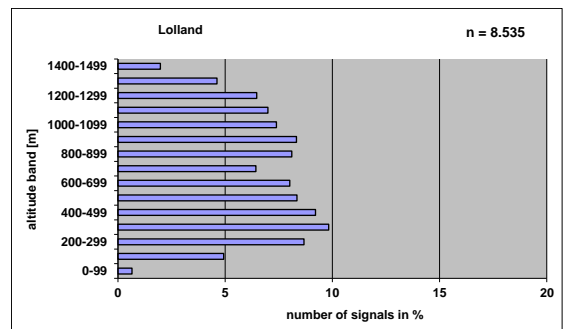
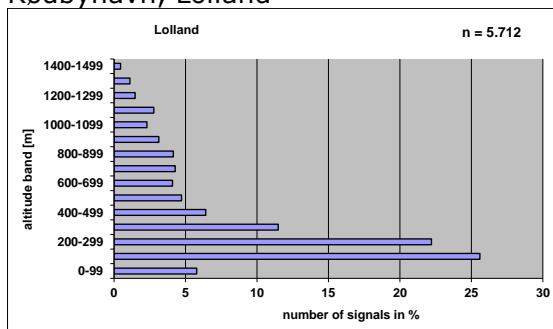

Puttgarden, Fehmarn

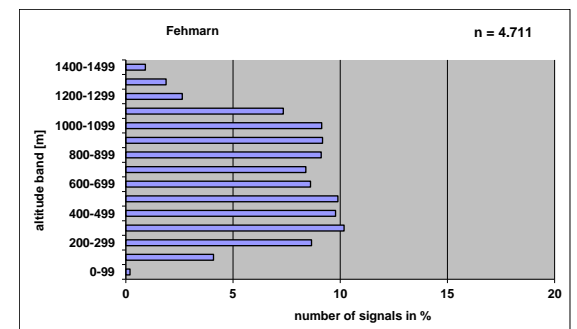
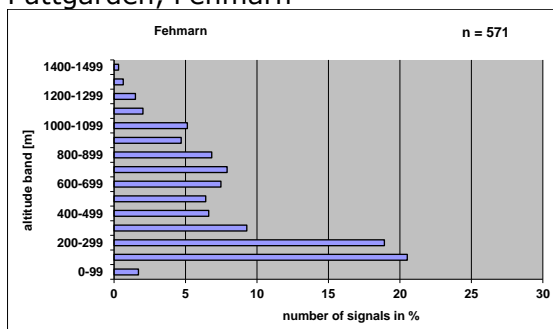

Westermarkelsdorf, Fehmarn

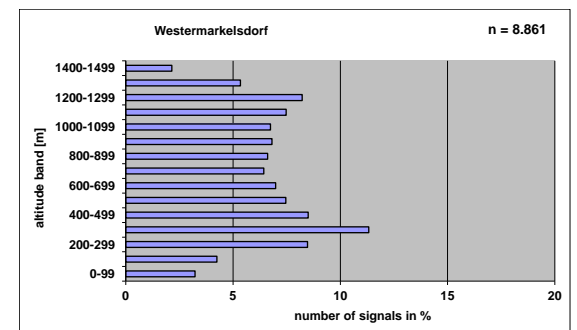
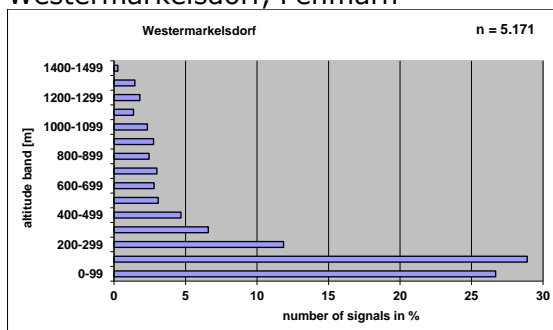

Figure 4.92 Altitude distributions night-time measured by surveillance radar at Rødbyhavn (top), Puttgarden (middle) and Westermarkelsdorf (bottom) on October 8, 2010 (left) and October 10, 2010 (right).

In summary, the general finding is that during intensive migration events, birds fly on average at higher altitudes than during periods of low migration. This applies to daytime but more so to night-time migration. It is assumed that truly migrating birds will choose their flight altitude according to the most favourable wind. The differences of the birds air speed to their ground speed, as investigated by tracking radar results in combination with altitudinal wind profiles, point to this fact. However, migration conditions maybe more favourable during one year, e.g. spring 2010 (Appendix B.4) as compared another, e.g. autumn 2009 (Appendix B.3).

In addition, the description and analyses of altitude profiles at the different stations in combination with the weather parameters further demonstrate the well-known fact that migration altitudes are lower in headwind situations, and that during favourable wind situations birds adapt their flight altitudes. It could also be demonstrated, that wind speed and direction will affect migration directions, with the effect that similar altitude profiles and intensities will only be registered at all stations, when winds blow NNE/SSW along the link, while during winds blowing perpendicular to the link, birds may only appear at one of the stations.

Results of the fixed pencil beam radar also confirm that large proportions of birds do fly at low altitudes, but that migration also occurs at altitudes beyond 1,500 m, which are not covered by the surveillance radars.

4.5 Three-dimensional flight paths as registered by the tracking radar

The Swiss tracking radar was active at Rødbyhavn during 2009 and at Puttgarden during 2010. In tracking mode it provides both mean altitudes and mean flight directions for each track; during daytime these tracks are identified with regard to species and flock size. In the following chapters, results are extracted and summarized from the technical reports of the Swiss Ornithological Institute (Appendix B.1 to B.5). This way, unique results are provided in particular for high flying birds which cannot be identified with any other method and may go unobserved.

4.5.1 Rødbyhavn, Lolland 2009

In spring 2009, 16,408 echoes of single birds or flocks of birds were tracked at Rødbyhavn. During daytime (from civil sunrise to civil sunset), 9,335 tracks were collected, 7,073 during night-time (Appendix B.1).

During night, 6,540 tracks were entered into the analyses, most of them (4,366=67 %) flying at altitudes > 500 m. Flight directions recorded were in general directed towards NE following the expected migration directions (Figure 4.93). Only for tracks at flight altitudes below 200 m (670=10.2 %) an additional direction component towards SE was observed, representing coast-parallel migration, most likely representing waterbirds or local gulls foraging in the area (Figure 4.93a).

FEHMARNBELT BIRDS

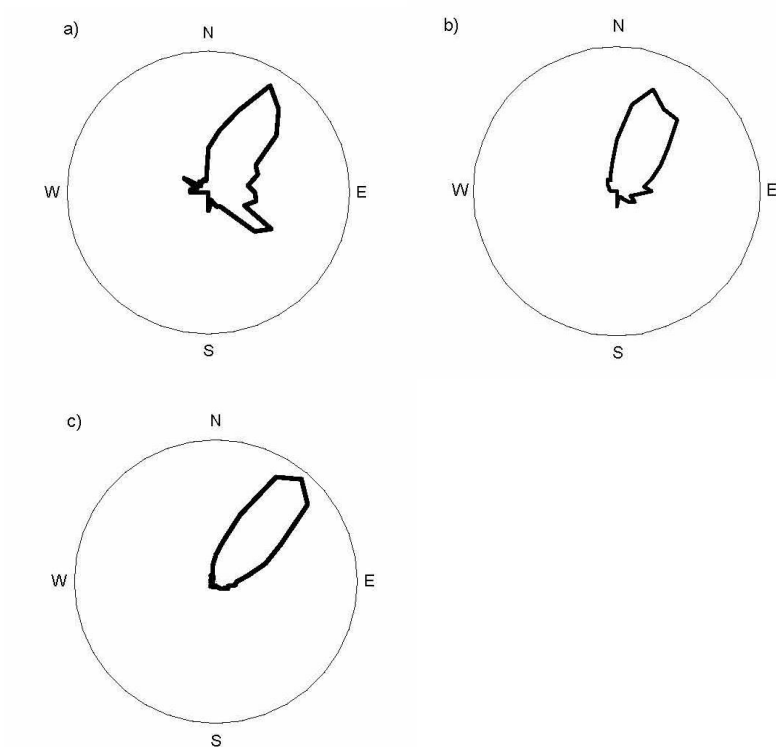

Figure 4.93 Spring 2009: Distribution of flight directions of nocturnal migrants in three height intervals: a) 0 to 200 m ($n = 310$); b) 201 and 500 m ($n = 318$); c) >500 m asl ($n = 4,366$). Data from tracking radar "Superfledermaus" were used.

During daytime, 8,573 tracks were collected, including the number of individuals. Different from the night-time, 42 % (3,572) of these were recorded at flight altitudes < 200 m. A large proportion of the low flying birds showed flight directions towards SE, representing mainly waterbirds in coast-parallel migration (Figure 4.94 a). A smaller proportion was observed flying towards NE, representing mainly landbirds or presumably gulls, cormorants and other local waterbirds. Tracks in the two other altitude categories 200-500 m and > 500 m almost exclusively were recorded flying in NE direction, that is over land (Figure 4.94 b,c).

FEHMARNBELT BIRDS

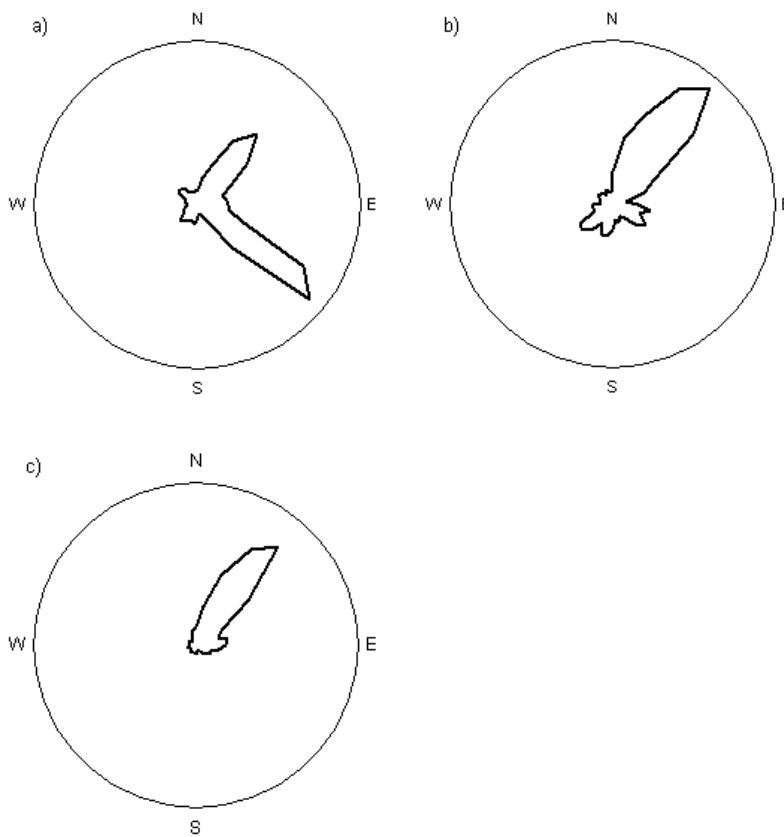

Figure 4.94 Spring 2009: Distribution of flight directions of diurnal migrants in three height intervals: a) 0 to 200 m ($n = 3,572$); b) 201 and 500 m ($n = 1,581$); c) >500 m asl ($n = 3,420$). Data from tracking radar "Superfledermaus" were used.

Flight speeds were generally higher at higher altitudes, due to a more favourable tailwind situation at those altitudes.

Species / species group identification was possible for 1,855 tracks representing 47,217 individuals. Among these, Common Eider and unidentified ducks showed a mean flight altitude < 50 m. A mean flight altitude of > 500 m was exhibited mainly by flocks of Wood Pigeons, Bar-tailed Godwits and Northern Lapwings going over land.

Regarding flight directions, Common Eiders and unidentified ducks were observed flying coast-parallel at low heights. European Sparrowhawks, Common and Honey Buzzards in turn flew towards NE with average heights of 170, 190 and 196 m respectively.

At end of May 2009 the migration event including waders was remarkable. After an unusually long period of easterly winds during mid-May, wind turned west in combination with high wind speed during late May persisting into early June. Waders staging in the Wadden Sea or elsewhere on their flyway made use of this change of weather conditions to take-off and migrate towards their breeding grounds. E.g. 35 flocks of Bar-tailed Godwits (13,415 individuals) were tracked during 27 May. Among these, low flying flocks were oriented coast-parallel, while high flying flocks clearly headed towards E, regardless of the coastline.

FEHMARNBELT BIRDS

In the summer period of 2009 (Appendix B.2), tracking during daytime proved to be unsuccessful at Rødbyhavn as there were no birds in the airspace to be tracked, with the exception of gulls foraging or flying towards or coming from roosting places. It turned out that the expected moult migration of seabirds could not be registered either due to the time period or inability to identify ducks to the species level.

Among the nocturnal tracks identified most belonged to Swifts. During the first half of July Swifts most likely represented resident birds, but during the second half of July migration has started as concluded from the more southerly directed tracks. Tracks were also registered for waders, ducks and gulls, and several flocks of Grey Herons. For most of these species the tracks showed a prevailing SW orientation, suggesting some early migratory movements (Figure 4.95).

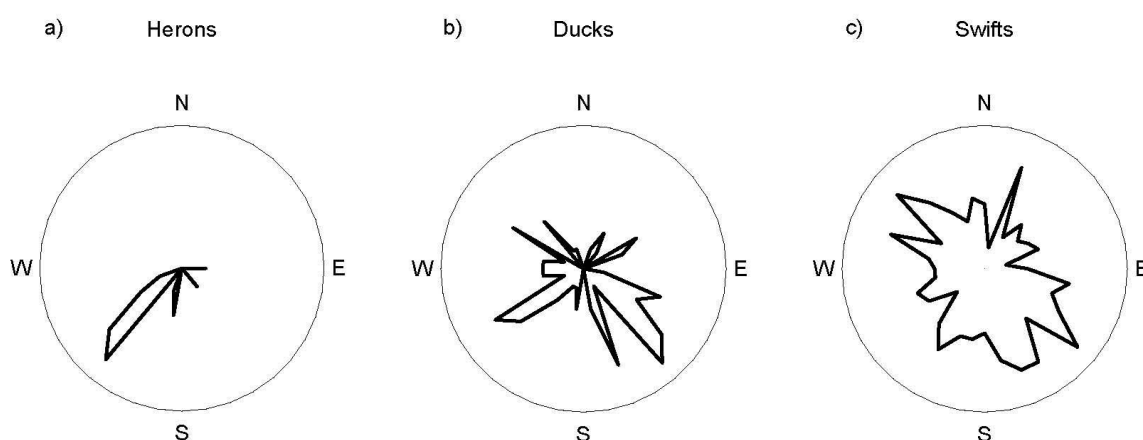

Figure 4.95 Summer 2009: Distribution of flight directions of herons (a), ducks (b) and swifts (c). Species groups were identified based on thermal imaging and wingbeat pattern ($n = 19, 68, 346$). Data from tracking radar "Superfledermaus" were used.

According to night-time tracking, 63 % of the 1,249 tracks were below 500 m altitude, but the overall flight altitudes were somewhat higher - even for ducks - if compared to tracked birds during spring 2009 at the same location.

During autumn 2009, 9,114 tracks sampled at Rødbyhavn, among these 4,981 tracks during daytime and 4,133 during night-time (Appendix B.3).

Overall flight directions were predominantly oriented towards SW, suggesting landbird migration crossing the Fehmarnbelt. Different from the spring 2009 migration season, a SE-NW migration (waterbirds) along the Fehmarnbelt was not obvious. This finding was supported by the visual observations at the Rødbyhavn field station, yielding high numbers of migrating ducks and geese only during spring, but not as many during autumn. Visual observations suggest that autumn waterbird migration occurred closer to the Fehmarn coast.

Results of the tracks with identified species ($n=1,070$) confirmed this assumption, as waterbird and wader migration could hardly be registered, whereas high numbers of birds of prey (e.g. European Sparrowhawk, Honey and Common Buzzard in 265 tracks with 947 individuals) and e.g. pigeons (114 tracks with 18,550 individuals) were regularly observed. Tracking results show that most birds of prey were flying at higher altitudes than during spring (see also chapter 4.6). A large number of non-identified tracks ($n=2,857$),

FEHMARNBELT BIRDS

presumably passerines, showed a broad distribution with mainly SW track directions. For some manually tracked and identified passerines, tracks revealed a pattern of first coast-parallel flight directions (NW-SE), then turning into coast-perpendicular flight directions (SW) plus increasing altitude. These patterns suggest that these birds are being hesitant to cross the Fehmarnbelt and "searching" for a good leaving point. Once they have "decided" to cross they steadily increased their flight altitudes over water (also see chapter 4.6).

During night-time flight altitudes of tracks were mainly recorded above 500 m (51 %) (Figure 4.96 c). During daytime, 25 % of the tracks were below 200 m, which is a smaller proportion than observed e.g. during spring, when large numbers of seaducks contributed to the fraction flying at low altitudes (Figure 4.97).

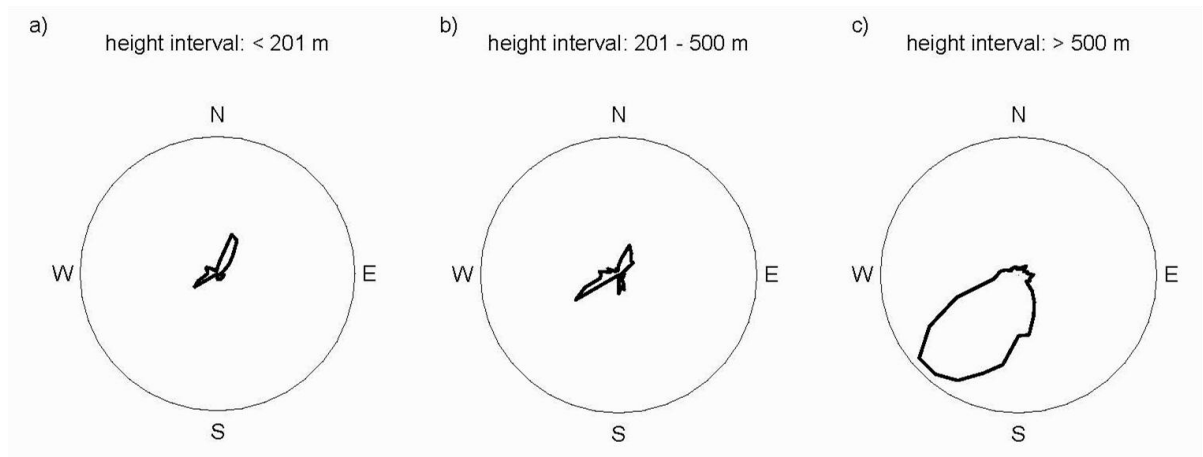

Figure 4.96 Autumn 2009: Distribution of flight directions of nocturnal migrants at three height intervals: a) 0 to 200 m ($n = 257$); b) 201 and 500 m ($n = 277$); c) >500 m asl ($n = 1,956$). Data from tracking radar "Superfledermaus" were used.

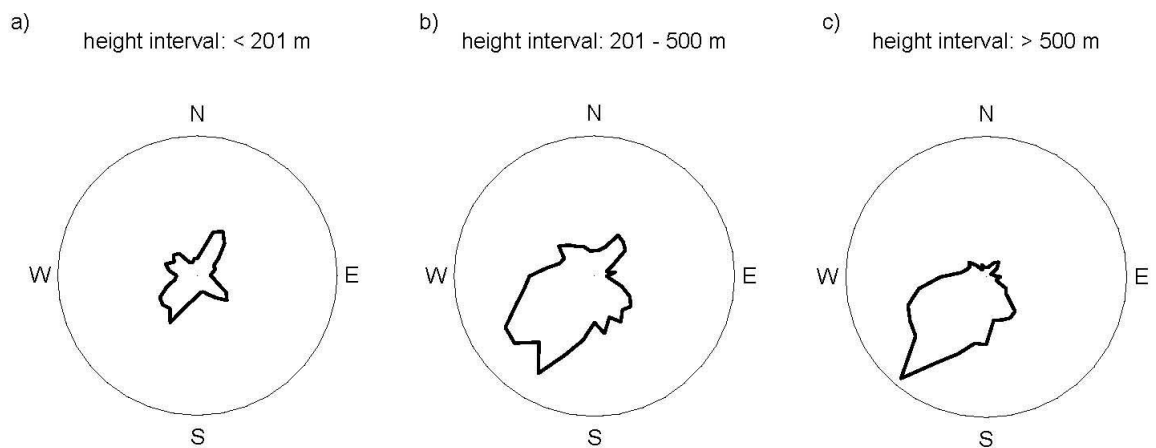

Figure 4.97 Autumn 2009: Distribution of flight directions of diurnal migrants in three height intervals: a) 0 to 200 m ($n = 1,149$); b) 201 to 500 m ($n = 1,975$); c) > 500 m asl ($n = 1,513$). Data from tracking radar "Superfledermaus" were used.

4.5.2 Puttgarden, Fehmarn 2010

During spring 2010, 16,534 echoes of single birds or flocks of birds were tracked at Puttgarden. During daytime, 7,157 tracks were collected, during night-time 9,377 (Appendix B.4).

During night-time, 8,613 tracks were identified as birds, and, corresponding to the findings in spring season 2009. Most of them (5,852=68 %) were observed at altitudes above 500 m (Figure 4.98 c). Also, the general flight direction towards NE was confirmed, and general flight direction patterns did not differ markedly between the two investigated seasons (Figure 4.98).

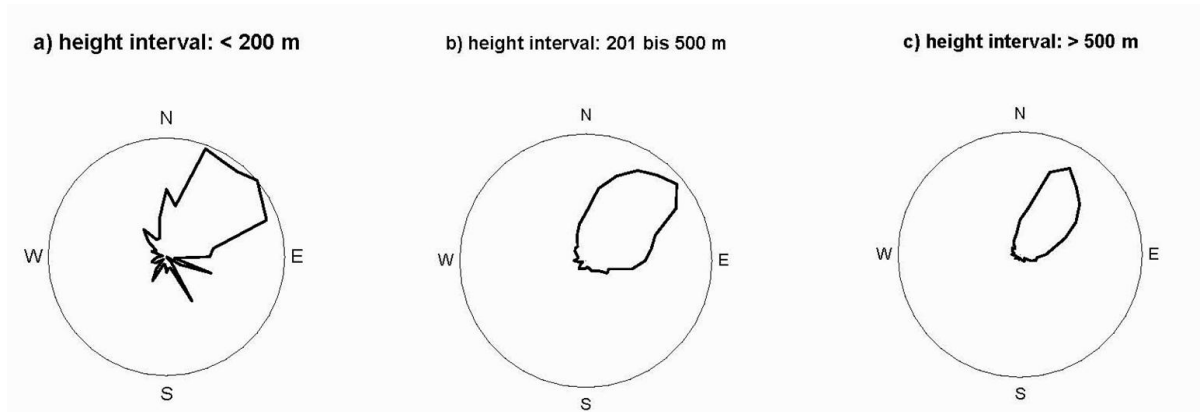

Figure 4.98 Spring 2010: Distribution of flight directions of nocturnal migrants at three height intervals: a) 0 to 200 m (N = 280); b) 201 and 500 m (N = 2481); c) >500 m asl (N = 5852). Data from tracking radar "Superfledermaus" were used.

During daytime, 5,534 tracks could be included into analysis of diurnal tracks with a large proportion of tracks identified at least to species group level. The general flight direction during daytime migration at all measured heights was also towards NE, with a second identified flight direction parallel to the coastline at altitudes below 200 m (Figure 4.99). The proportion of birds observed flying in low altitudes below 200 m was 25 % lower than in the previous year at the field site in Rødbyhavn (42 %), which may be due to technical reasons, as detection of low elevations was more disturbed at the Puttgarden compared to the Rødbyhavn location.

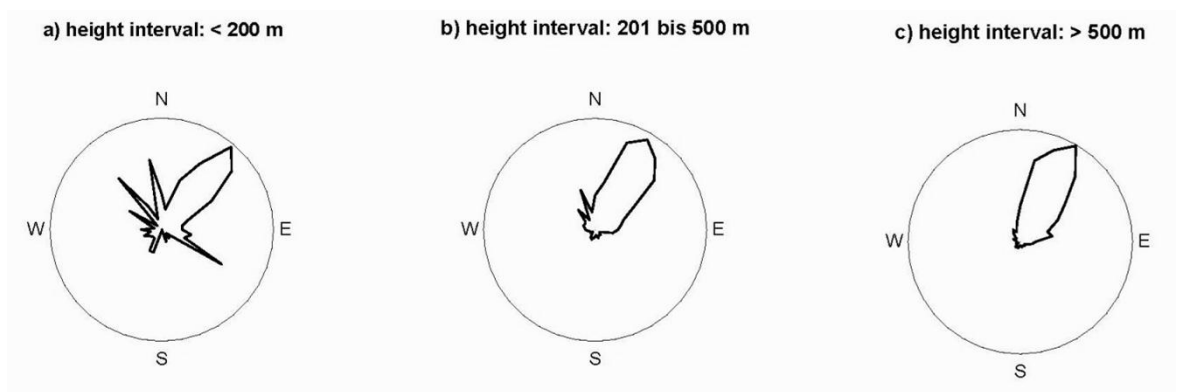

Figure 4.99 Spring 2010: Distribution of flight directions of diurnal migrants in three height intervals: a) 0 to 200 m (N = 183); b) 201 and 500 m (N = 1366); c) > 500 m asl (N = 3985). Data from tracking radar "Superfledermaus" were used.

FEHMARNBELT BIRDS

The flight speed of nocturnal migrants was higher at altitudes above 200 m, indicating a tailwind support during spring 2010 at these higher altitudes. The diurnal mean air speed remained on the same level at all height intervals. Below 500 m the ground speed was slightly lower than above 500 m, indicating a tendency of more headwind conditions at lower altitudes and more tailwind conditions at higher altitudes.

During daytime, a total of 32 species or taxa were identified and tracked, in total 417 tracks representing 5,270 individuals. Compared to observations in 2009 at the Danish coast, the number of tracked and identified birds was lower, and also species composition varied with the study site. In Puttgarden the most prominent tracked species was Honey Buzzard (71 tracks, 117 individuals), followed by unidentified doves (59 tracks, 3,938 individuals), both flying at a mean altitude above 500 m.

Among the tracked species the main flight direction was NE, and only Wood Pigeon was recorded flying towards N/NW (15 tracks, 461 individuals). Also a high proportion of unidentified diurnal migrants (presumably mostly passerines) showed a mean flight direction towards NE.

During autumn 2010 at Puttgarden, 8,644 tracks have been identified as flying birds, among which 3,794 have been sampled during daytime and 4,850 during night-time (Appendix B.5).

The observed night-time distribution of the flight directions reveals that the main flight direction was towards SW, suggesting landbird migration crossing the Fehmarnbelt (Figure 4.100). However, there was also a proportion of birds recorded flying towards NW, most likely representing coast-parallel migrating waterbirds, which was also confirmed by visual observations at Puttgarden field site for autumn migration. The general flight direction pattern of autumn migration 2010 did not differ from the one measured during autumn migration 2009 in Rødbyhavn.

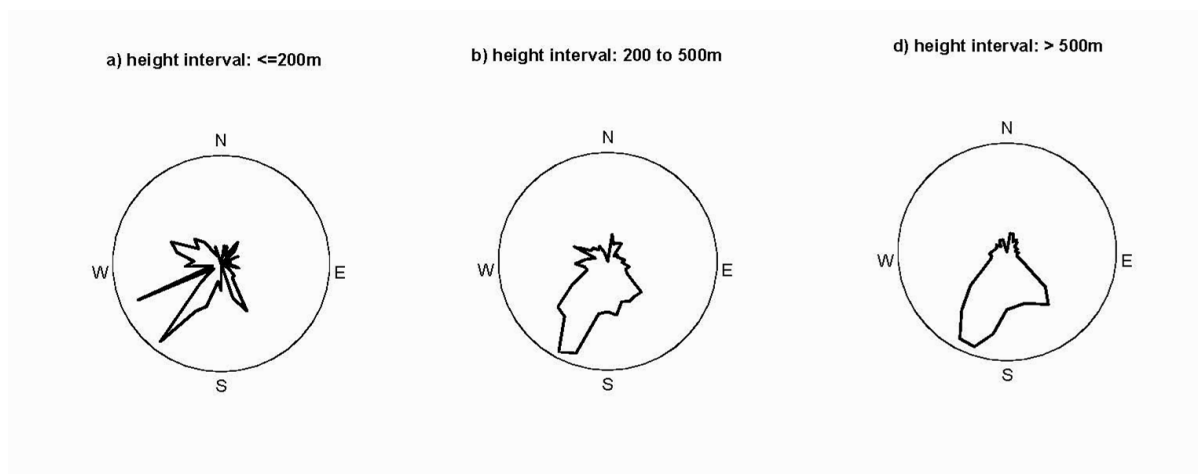

Figure 4.100 Autumn 2010: Distribution of flight directions of nocturnal migrants at three height intervals: a) 0 to 200 m ($N = 104$); b) 201 and 500 m ($N = 900$); c) >500 m asl ($N = 3,354$). Data from tracking radar "Superfledermaus" were used.

FEHMARNBELT BIRDS

In autumn 2010 46 species or taxa were identified and tracked during diurnal migration with a total of 604 tracks representing 26,350 individuals. Among the identified and unidentified bird species a main flight direction towards SW was recorded (Figure 4.101). Only Cormorants were recorded heading towards W/NW.

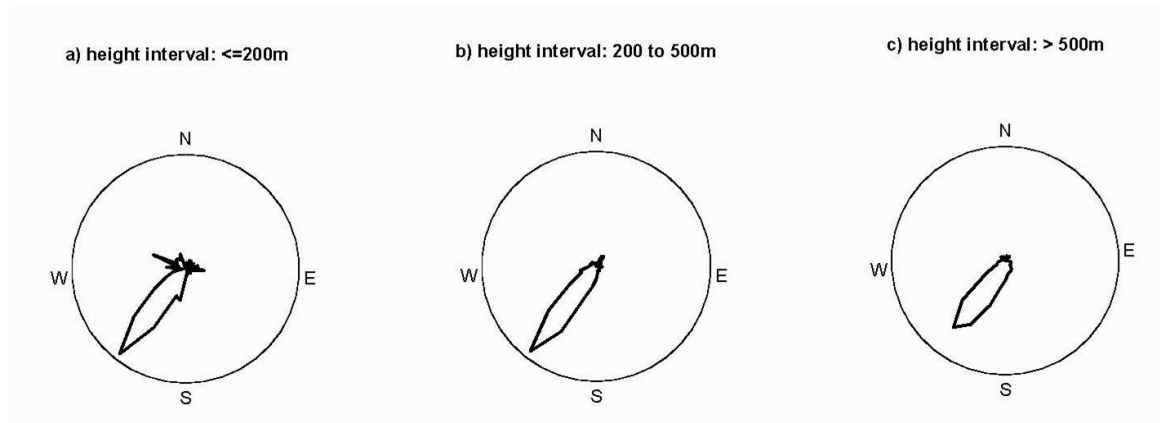

Figure 4.101 Autumn 2010 :Distribution of flight directions of diurnal migrants in three height intervals: a) 0 to 200 m (N =200); b) 201 and 500 m (N = 1,125); c) > 500 m asl (N = 2,193). Data from tracking radar "Superfledermaus" were used.

Compared to observations at the Danish coast in 2009, in general the number of tracked and identified birds was lower, but this was due to a shift in the data collection design. The most prominent species among identified daytime tracked birds were Wood Pigeon (111 tracks, 17,000 ind.), followed by birds of prey (e.g. European Sparrowhawks with 72 tracks/ 79 ind.; buzzards with 128 tracks/307 ind.) and geese (e.g. Greylag Goose 19 tracks/1,050 ind. and Barnacle Goose 16 tracks/1,941 ind.).

In summary, it can be noted that individual tracking largely confirmed expected migration directions. Birds at high altitudes, of which it can be assumed that the majority belongs to songbirds, will cross the Fehmarnbelt towards NE in spring and towards SW in autumn. Tracks at the lower altitudes will stem from waterbirds migrating more or less coast-parallel.

4.6 **Arrival at and departures from the coasts – analysis of bird behaviour and strategies**

Migratory flight consists of three parts – taking off, landing and the cruise plain flight itself including ascending and descending phases. Behaviour of the birds differs between these parts of the flight, and environmental conditions affect these three types of behaviour differently. Using tracking radar provides a unique opportunity to study all parts of migratory flight allowing conclusions about the importance of environmental conditions on each part of the flight separately.

Several methods of radar tracking were used to obtain information about the individual behaviour of birds during migration:

FEHMARNBELT BIRDS

- Daytime tracking – objects were identified visually and followed for longer distances. This method provides the most accurate information about the migratory behaviour of the bird as long as it allows precise visual identification of the object and its position in the three-dimensional space.
- Night-time tracking (long tracks) – same as daytime tracking, but objects are unidentified or at best grouped into a few size classes.
- Night-time tracking (short tracks) – objects are tracked using an automatic mode of the tracking radar and are followed for 20 seconds. This mode allows to collect a flight path for 100 to 300 m (depending on ground speed), which is considered to be adequate for calculating flight direction and speed. Significant changes in direction within this time interval are rare for nocturnal migrants (F. Liechti, pers. comm.).

Analyses in this chapter focussed on long tracks during daytime and night-time, offering the opportunity to describe flight paths and altitudes.

During daytime in spring and autumn 2009, 1,855 and 1,070 tracks were visually identified, respectively. The accuracy of species identification varied from precise species recognition to identifying the size class of the bird, but all these tracks were identified as birds, and thus the parameters of the tracks definitely reflect natural behaviour of the birds, most of these assumed to be migrating.

One interesting parameter to study when analysing the bird's behaviour in the air is its vertical speed (V_z). If $V_z > 0$, the bird is ascending, if $V_z < 0$, the bird is descending. On the basis of these values it is possible to identify the phase of the flight and to assess the strategy a bird uses at that particular stage of migration. During the cruising phases ascending and descending phases occur, leading to a variation of the vertical speed around zero. However, during take-off and landing the vertical speed is markedly different from zero. Although the vertical speed of the tracks has a continuous distribution, for the statistical analysis of taking off and landing behaviour three operational groups of tracks are defined on the basis of the value of vertical speed following Hedenström et al. (2002). The vertical speed is less than minus (-)50 cm/sec for the landing birds, while above plus (+)50 cm/sec for birds taking off. Vertical speeds between -50 and +50 cm/sec characterise plain cruise flight.

4.6.1 Identified tracks at daytime 2009

Every species has its individual strategy of migration between breeding and wintering grounds and of overcoming geographical obstacles on the flyway.

A list of species and their vertical speed (V_z), as observed at Rødbyhavn, is given in Table 4.20 for spring and in Table 4.21 for autumn 2009. The seasonal mean and median vertical speed for all species for both spring and autumn migration was close to 0. In spring most of the birds arriving at the Lolland coast were descending (Table 4.20). However, geese, seaducks and waders, birds which travel long distances to arctic breeding areas, were observed to gain height irrespective of the local terrain. During autumn, some groups of species like waders, some species of small passerines and pigeons effectively gained height before crossing the Fehmarnbelt (Table 4.21).

FEHMARNBELT BIRDS

Table 4.20 Statistics of vertical speed (V_z , cm/sec) for tracks with identified species, Rødbyhavn, spring 2009; only for species with $N \geq 10$. Data from tracking radar "Superfledermaus" were used.

Species	Mean	Median	STD	Minimum	Maximum	N
	[cm/sec]					
<i>Great Cormorant</i>	-2.5	4.0	47.7	-195	109	45
<i>Greylag Goose</i>	2.4	12.0	48.6	-112	88	13
<i>Brent Goose</i>	11.8	11.0	41.8	-80	134	21
<i>Branta geese</i>	18.0	30.0	64.8	-154	86	11
<i>diving ducks</i>	3.5	1.0	34.1	-174	134	113
<i>Common Eider</i>	-0.2	-1.0	26.1	-335	114	406
<i>Honey Buzzard</i>	-37.0	-36.5	48.1	-120	174	40
<i>Sparrowhawk</i>	-25.9	-20.0	34.2	-141	72	73
<i>Common Buzzard</i>	-35.7	-37.0	37.1	-130	69	53
<i>Common Crane</i>	-12.6	-15.0	26.3	-69	31	22
<i>Bar-tailed Godwit</i>	14.2	12.0	22.3	-32	54	35
<i>Common gull</i>	-4.7	-3.0	23.1	-46	28	14
<i>Herring / Lesser black-backed Gull</i>	8.5	3.0	68.9	-90	257	23
<i>Black-headed Gull</i>	-23.0	-7.0	60.2	-243	48	32
<i>gulls</i>	-5.4	2.0	73.6	-799	281	313
<i>terns</i>	16.3	-9.0	60.5	-68	154	15
<i>Wood Pigeon</i>	-39.7	-26.0	43.6	-130	13	13
<i>pigeons</i>	-59.3	-35.0	79.4	-290	66	33
<i>Common Swift</i>	-22.9	-12.5	98.4	-344	136	34
<i>Skylark</i>	-12.8	-3.0	59.2	-93	108	11
<i>Barn Swallow</i>	-21.0	-6.5	71.2	-188	64	10
<i>swallows</i>	-8.5	5.5	56.6	-104	104	26
<i>Chaffinch</i>	-83.3	-76.5	32.4	-164	-42	12
Total – of all species, including those with less than 10 individuals	-9.2	-4.0	53.9	-799	281	1,854

FEHMARNBELT BIRDS

Table 4.21 Statistics of vertical speed (V_z , cm/sec) for tracks with identified species, Rødbyhavn, autumn 2009; only for species with $N \geq 10$. Data from tracking radar "Superfledermaus" were used.

Species	Mean	Median	STD	Minimum	Maximum	N
	[cm/sec]					
Great Cormorant	8.3	-1.0	61.9	-92	164	19
Grey Heron	-2.1	-4.0	21.0	-29	26	10
Greylag Goose	0.4	-3.0	40.7	-123	68	23
Anser geese	-1.1	-2.5	55.7	-181	240	58
Barnacle Goose	-0.5	0.0	19.9	-38	53	24
diving ducks	-12.5	-8.0	53.2	-166	79	25
Honey Buzzard	-12.4	-12.5	39.1	-129	114	90
Sparrowhawk	-6.2	-3.5	74.7	-254	246	118
Common Buzzard	-9.2	-9.0	88.9	-310	176	57
buzzards	-36.8	-48.5	51.9	-106	54	12
Marsh Harrier	14.9	17.0	73.5	-108	150	10
Black-headed Gull	-29.8	-38.0	80.3	-175	118	11
gulls	-21.6	-21.5	97.3	-351	318	116
Sandwich Tern	-3.0	-3.0	.	-3	-3	1
Wood Pigeon	21.4	40.0	113.1	-752	178	84
pigeons	-14.7	4.0	80.9	-195	100	30
Common Swift	-14.2	-14.0	81.5	-246	137	38
swallows	25.8	34.0	82.1	-229	186	71
Rook	-33.9	-18.5	67.4	-194	55	10
Total – of all species, including those with less than 10 individuals	-9.2	-6.0	81.7	-752	318	1,070

The speed of ascending birds of several species as measured by radar (Hedenstroem and Alerstam 1992) ranges from 36 cm/sec for swans to maximum 214 cm/sec for Dunlins (see Table 4.22 after Hedenström and Alerstam 1992). During spring and autumn 2009, ascending tracks had vertical speeds comparable to those reported by Hedenström and Alerstam (1992).

Table 4.22 Ascending speed for several bird species (modified from Hedenström and Alerstam 1992). Data from tracking radar "Superfledermaus" were used.

Species	$V_z \pm S.D.$ [cm/sec]	Mean altitude [m]	Number of tracks	Months
Mute Swan	32 ± 15	259	4	Oct
Greylag Goose	46 ± 11	351	6	Sep-Oct
Common Eider	41 ± 10	276	35	Jul, Sep-Oct
Red-throated Diver	49 ± 17	592	37	Sep-Oct
Brent Goose	53 ± 18	312	20	Sep-Oct
Curlew	107 ± 26	770	5	Jul
Eurasian Wigeon	90 ± 32	451	12	Sep

FEHMARNBELT BIRDS

Species	Vz ±S.D. [cm/sec]	Mean altitude [m]	Number of tracks	Months
Wood Pigeon	68 ± 18	322	46	Mar-Apr
Oystercatcher	86 ± 20	704	4	Jul, Sep
Arctic Tern	124 ± 22	1074	15	Jul-Sep
Song Thrush	100 ± 21	733	10	Mar-Apr
Dunlin	163 ± 41	717	10	Jul
Swift	134 ± 30	783	7	Jul-Aug
Chaffinch	102 ± 33	387	24	Apr
Siskin	84 ± 23	529	7	Sep-Oct

The measurements of vertical speed of the identified tracks from the present study and published results from other studies provide the range of natural variation of these parameters for the analysis of unidentified tracks at night.

In the following examples of species are further analysed and described. Species were selected basically due to the availability of sufficient data with regard to tracks and track lengths.

Barnacle Goose

In spring 2009 all but one (n=9) of the recorded flocks of Barnacle Goose were flying along the coastline at low altitudes (Figure 4.102, Figure 4.103). This is one possibility, as many flocks of Barnacle Goose also arrive from over sea at higher altitudes and migrate towards E crossing over the coastline to continue over land (chapter 4.3.2).

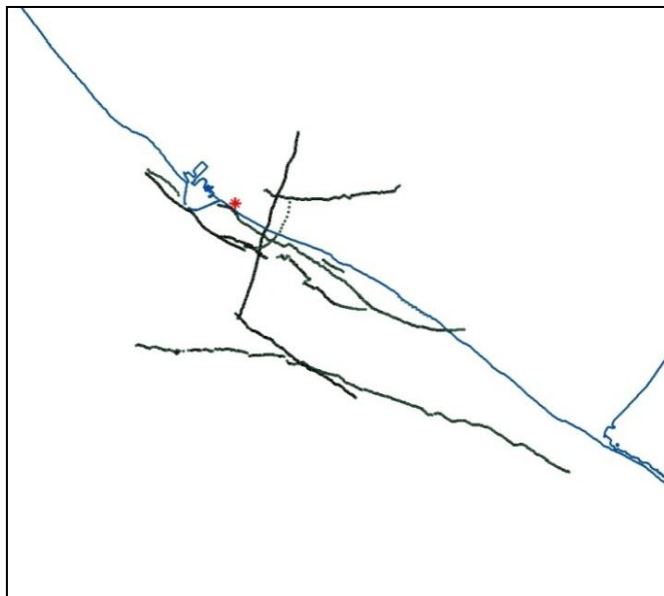

Figure 4.102 Tracks of Barnacle Goose, Rødbyhavn spring 2009, n=9. Data from tracking radar "Superfledermaus" were used.

FEHMARNBELT BIRDS

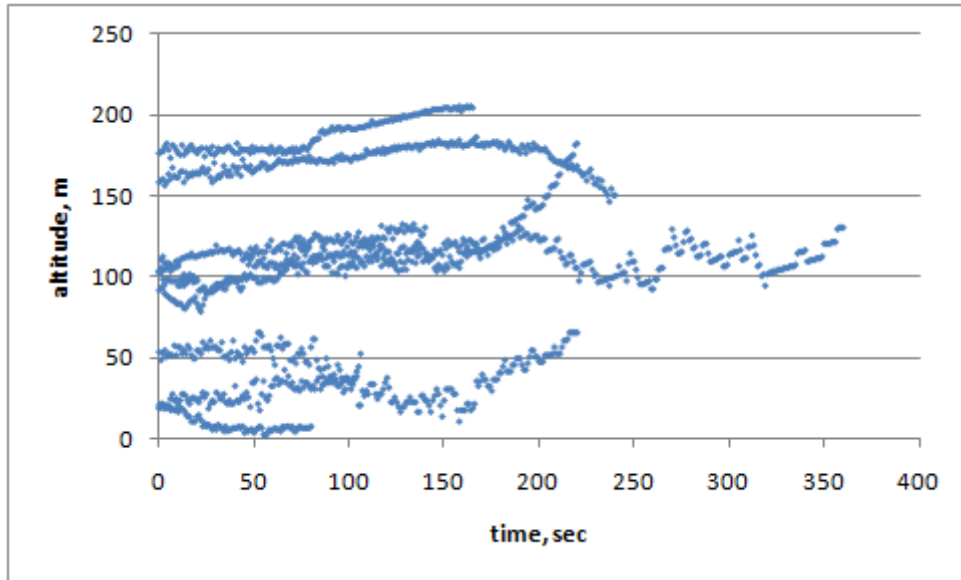

Figure 4.103 Dynamics of altitude change during the migratory flight in Barnacle Goose as recorded at Rødbyhavn during spring 2009 (n=9). The frequent small amplitudes of the track heights may be due to the 'Superfledermaus' switching targets within large flocks. Data from tracking radar "Superfledermaus" were used.

During autumn 2009, 24 flocks of Barnacle Goose were identified and tracked. They did not change flight direction or altitude when crossing the coastline. All tracks indicated the birds crossed more or less perpendicular to the coastline (Figure 4.104, Figure 4.105), comparing well to results from real-time tracking in 2010 (see chapter 4.3.2). Flight altitudes were variable, with most below 1,000 m, but two tracks beyond.



Figure 4.104 Tracks of Barnacle Goose, Rødbyhavn autumn 2009 (n=24). Data from tracking radar "Superfledermaus" were used.

FEHMARNBELT BIRDS

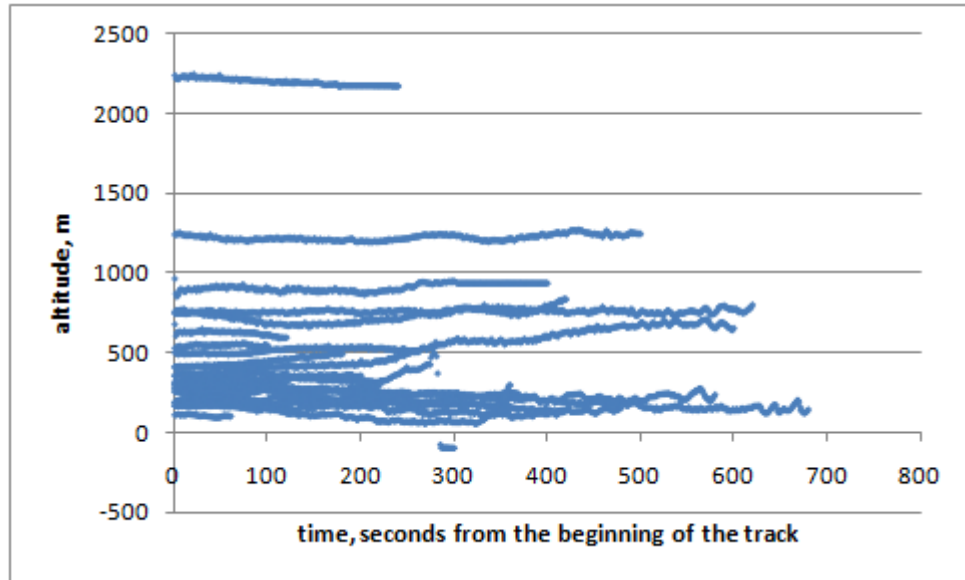

Figure 4.105 Dynamics of altitude change during the migratory flight in Barnacle Goose as recorded in Rødbyhavn in autumn 2009 ($n=24$). Data from tracking radar "Superfledermaus" were used.

Honey Buzzard

In spring 2009 Honey Buzzards approached the coastline quickly descending while gliding down towards the land (Figure 4.108 and Figure 4.109).

In autumn 2009 migration of Honey Buzzards took place between end of August and beginning of September (see chapter 0). In comparison to Sparrowhawks, Honey Buzzards were less often observed zigzagging in relation to the wind direction (Figure 4.106, Figure 4.108), but used a sinusoidal flight to gain height (Figure 4.107, Figure 4.109). This difference may be due to a species specific flight pattern or due to e.g. temperature and atmospheric circulation in these periods of the season, as Honey Buzzards normally migrate earlier than Sparrowhawks.

FEHMARNBELT BIRDS

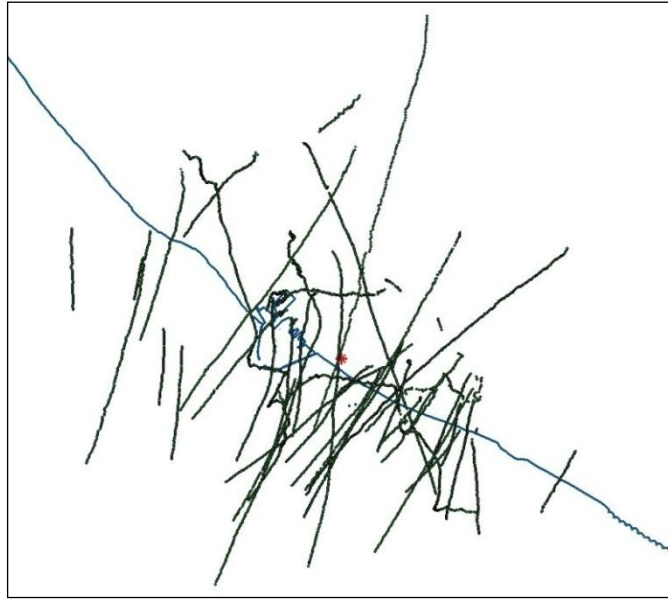

Figure 4.106 Tracks of Honey Buzzard, Rødbyhavn spring 2009, n=40. Data from tracking radar "Superfledermaus" were used.

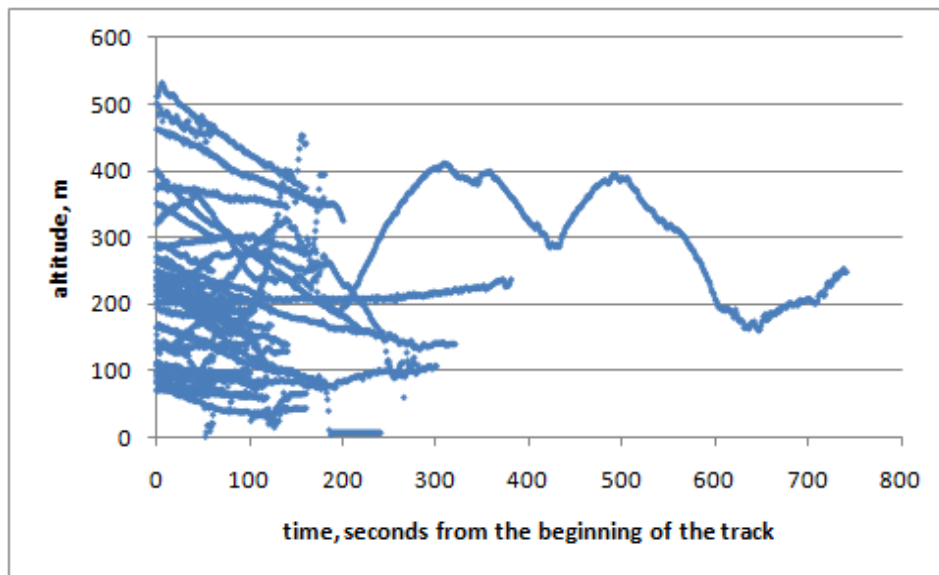

Figure 4.107 Dynamics of altitude change during the migratory flight in Honey Buzzards as recorded at Rødbyhavn in spring 2009, n=40. Data from tracking radar "Superfledermaus" were used.

FEHMARNBELT BIRDS

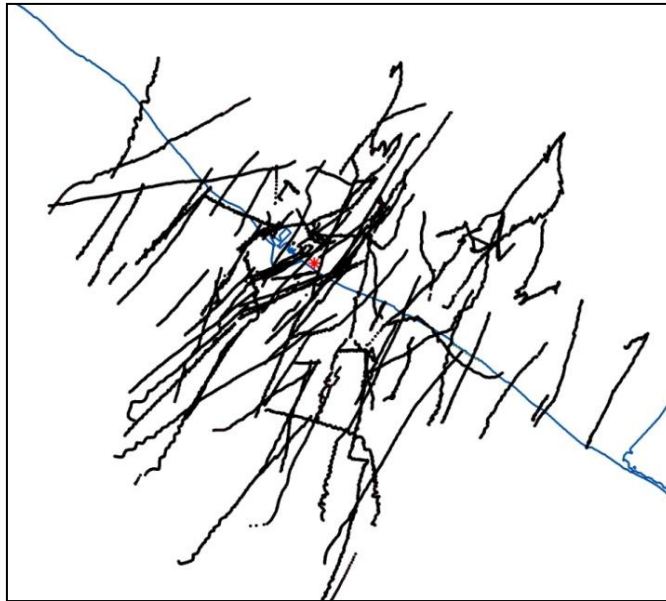

Figure 4.108 Tracks of Honey Buzzards, Rødbyhavn autumn 2009, n=90. Data from tracking radar "Superfledermaus" were used.

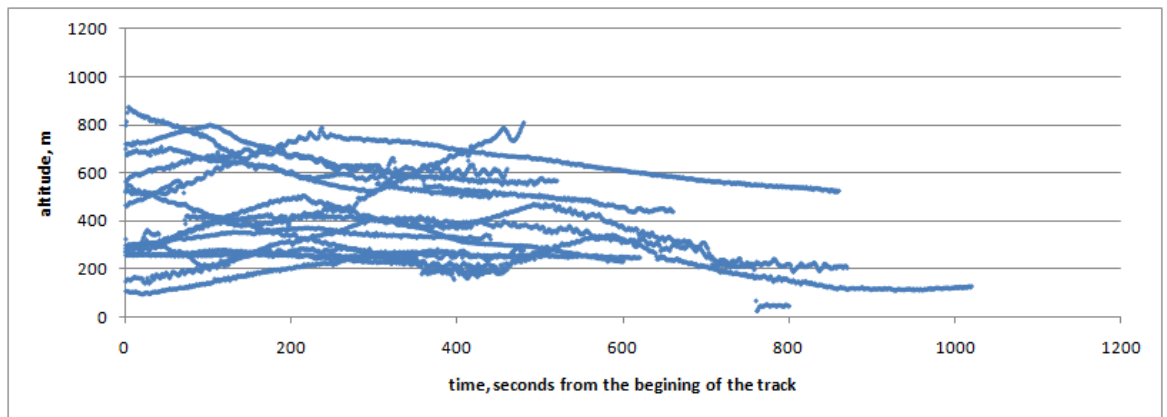

Figure 4.109 Dynamics of altitude change during the migratory flight in Honey Buzzards as recorded at Rødbyhavn in autumn 2009 (example of 13 longest tracks). Data from tracking radar "Superfledermaus" were used.

Marsh Harrier

In spring 2009, Marsh Harriers were observed gliding down towards Lolland coast reducing altitude (Figure 4.110, Figure 4.111). During autumn 2009, similarly to Sparrowhawk and Honey Buzzard, the Marsh Harriers also used wind to gain height, but the sequence of the circling and gliding phases of the Marsh Harrier were less regular, and the pattern of altitude change appeared to be more variable (Figure 4.112, Figure 4.113).

FEHMARNBELT BIRDS

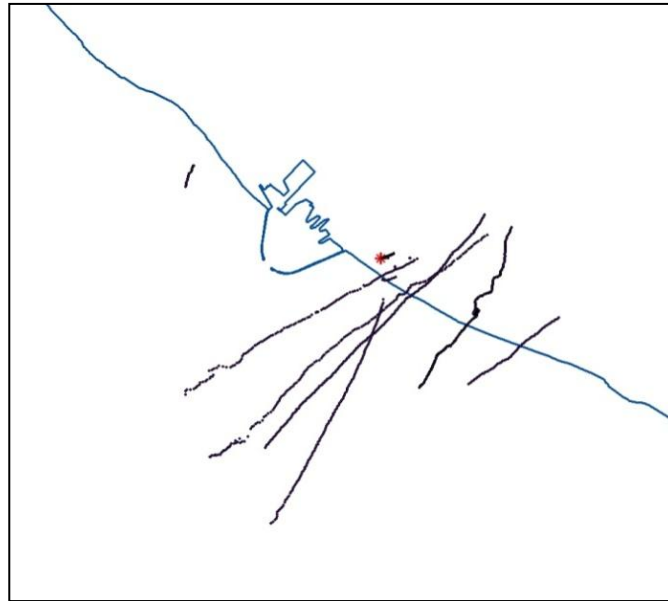

Figure 4.110 Tracks of Marsh Harrier, Rødbyhavn spring 2009 (n=7). Data from tracking radar "Superfledermaus" were used.

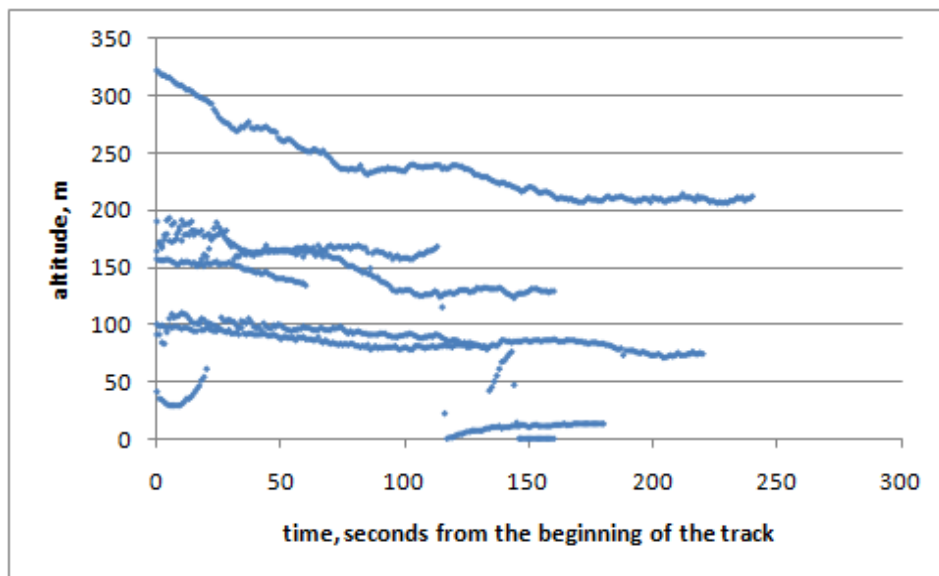

Figure 4.111 Dynamics of altitude change during the migratory flight in Marsh Harrier as observed at Rødbyhavn in spring 2009, n=7. Data from tracking radar "Superfledermaus" were used.

FEHMARNBELT BIRDS

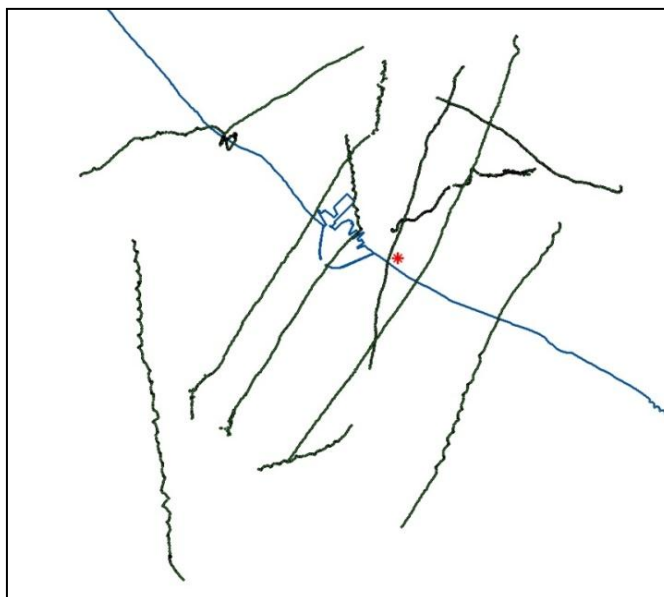

Figure 4.112 Tracks of Marsh Harriers, Rødbyhavn autumn 2009 (n=10). Data from tracking radar "Superfledermaus" were used.

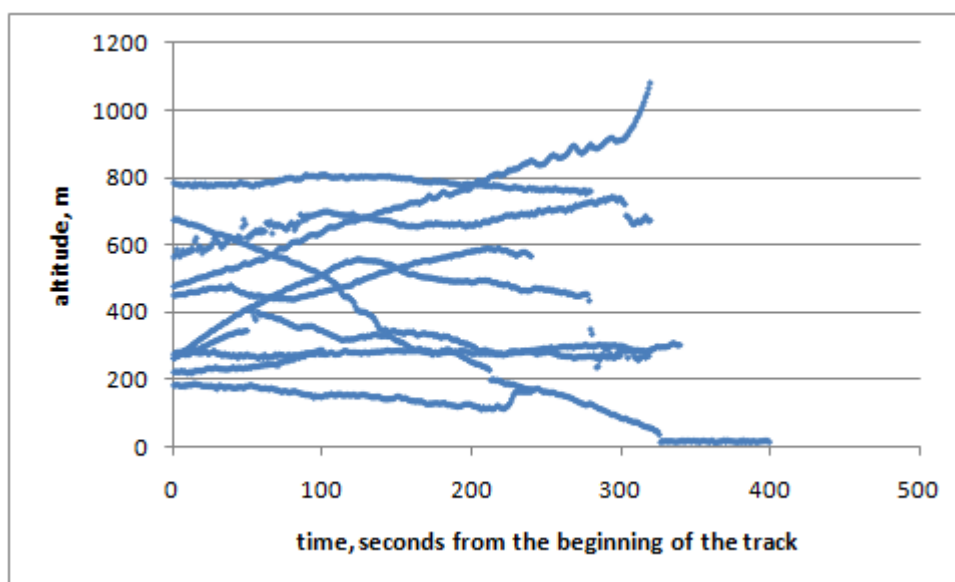

Figure 4.113 Dynamics of altitude change during the migratory flight in Marsh Harrier as observed at Rødbyhavn during autumn 2009 (n=10). Data from tracking radar "Superfledermaus" were used.

European Sparrowhawk

In 2009 the number of visually identified tracks of Sparrowhawk was 73 for spring (mean track altitude = 170 m) and 118 for autumn (mean track altitude = 409 m).

During spring Sparrowhawk tracks were more or less linear lines, and they crossed the coastline at a lower altitude than in autumn. It can be assumed that they had gained height over Fehmarn using thermals, and were gliding towards the Lolland coast, reaching sea level somewhere mid-way of the Fehmarnbelt and performed active flight until they reached land (Baisner et al., 2010). Single

FEHMARNBELT BIRDS

tracks indicate that birds ascend when reaching land (Figure 4.114 and Figure 4.115).



Figure 4.114 Tracks of Sparrowhawks, Rødbyhavn spring 2009 (n=73). Data from tracking radar "Superfledermaus" were used.

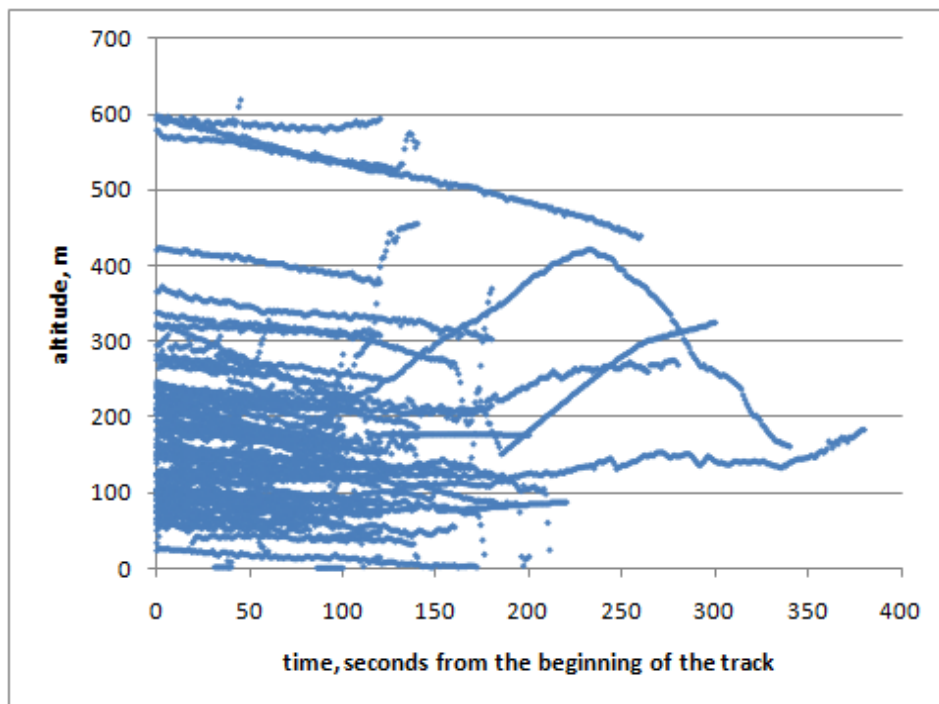

Figure 4.115 Dynamics of altitude change during the migratory flight in Sparrowhawk, arriving at Rødbyhavn in spring 2009 (n=73). Data from tracking radar "Superfledermaus" were used.

FEHMARNBELT BIRDS

In autumn 2009 the majority of the Sparrowhawk tracks were recorded during mid-September and some tracks in October (see Appendix B.3).

Observations during autumn 2009, when Lolland represented the departure coast, showed that migratory flights of Sparrowhawks often consists of two parts – gaining height flying with the wind and gliding down from achieved height towards the migratory direction (Figure 4.116). When gaining height, birds were drifting with the wind producing a circling or irregular track, while the gliding flight produced rather linear tracks. The overall direction of the track when birds were gaining height and circling was almost always along the wind direction. The gliding part appears to be less affected by the wind, but birds still may drift. Among the observations the longest ascending part of the track was 1,470 m, while the longest gliding distance and descending part of the track registered was 3,400 m. Probably the elevation of the highest part of the track depends on the actual weather conditions (Figure 4.117). Birds were observed zigzagging and gaining height also above water at a distance of several kilometres from the coastline, probably using updrafts and bubbles of warm air generated onshore but also extending to offshore.



Figure 4.116 Example of longest tracks of Sparrowhawks recorded at Rødbyhavn in autumn 2009 (n=24). Data from tracking radar "Superfledermaus" were used.

FEHMARNBELT BIRDS

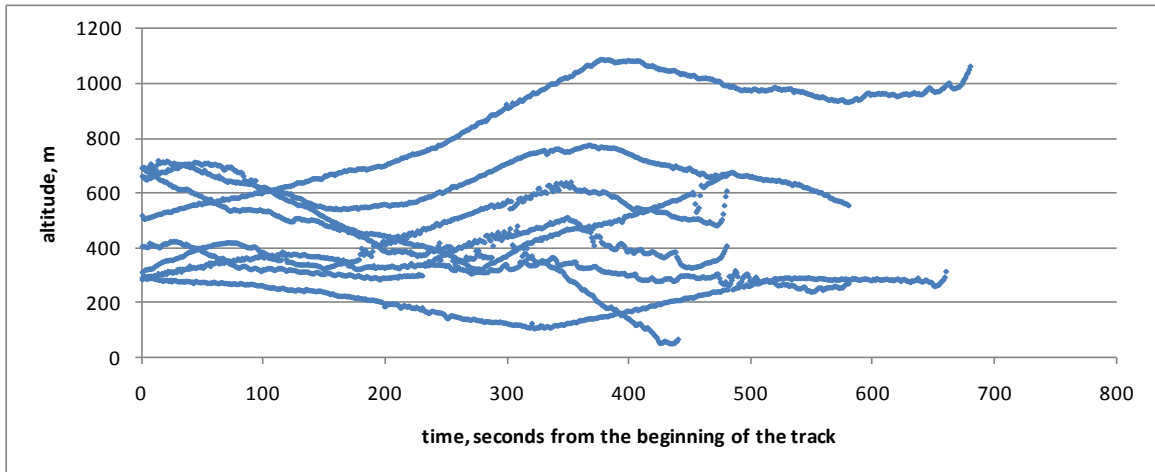

Figure 4.117 Dynamics of altitude change during the migratory flight of Sparrowhawks (example of 8 longest tracks), autumn 2009. Data from tracking radar "Superfledermaus" were used.

Wood Pigeon

In spring 2009 Wood Pigeon flocks (n = 13) were observed approaching the coastline of Lolland without changing altitude or sometimes slowly descending (Figure 4.118, Figure 4.119).

During autumn 2009, tracks (n=84) of Wood Pigeons often indicated birds zigzagging before crossing the Fehmarnbelt in order to gain height, and then flocks continued to gain height almost all the way until reaching the opposite coast at Puttgarden. These were the longest tracks registered by the tracking radar, since those large flocks of Wood pigeons produced a strong signal that could be followed up to 16 km. An apparent change of direction occurred during these crossing flights, as birds start heading towards SW, apparently adjusting towards Puttgarden at some point over the Fehmarnbelt (Figure 4.120, Figure 4.121).

FEHMARNBELT BIRDS

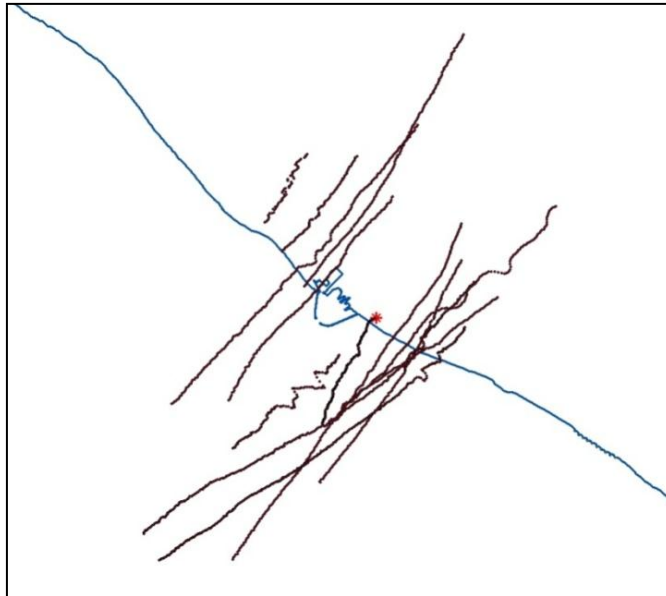

Figure 4.118 Tracks of Wood Pigeon, Rødbyhavn spring 2009, n=13. Data from tracking radar "Superfledermaus" were used.

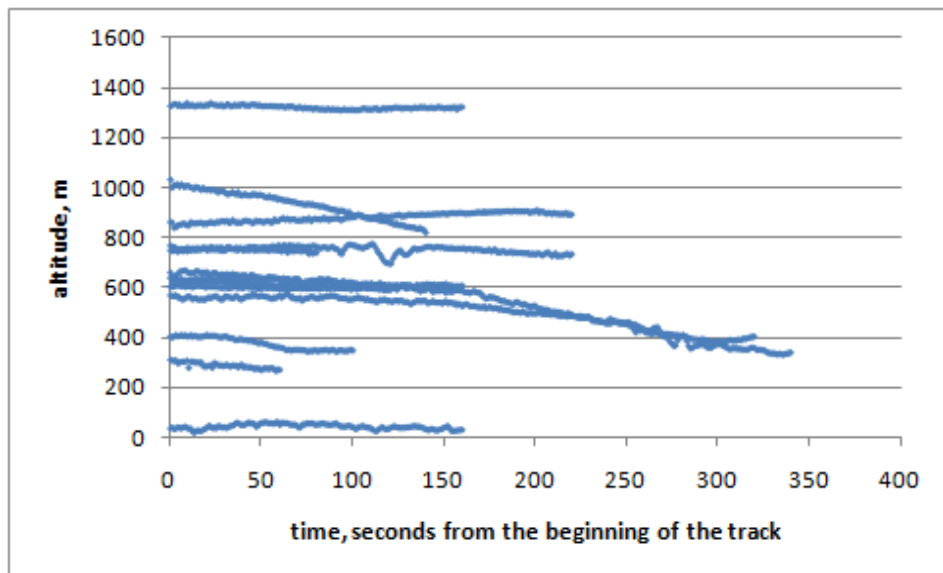

Figure 4.119 Dynamics of altitude change during the migratory flight in Wood Pigeons as recorded at Rødbyhavn in spring 2009, n=13. Data from tracking radar "Superfledermaus" were used.

FEHMARNBELT BIRDS

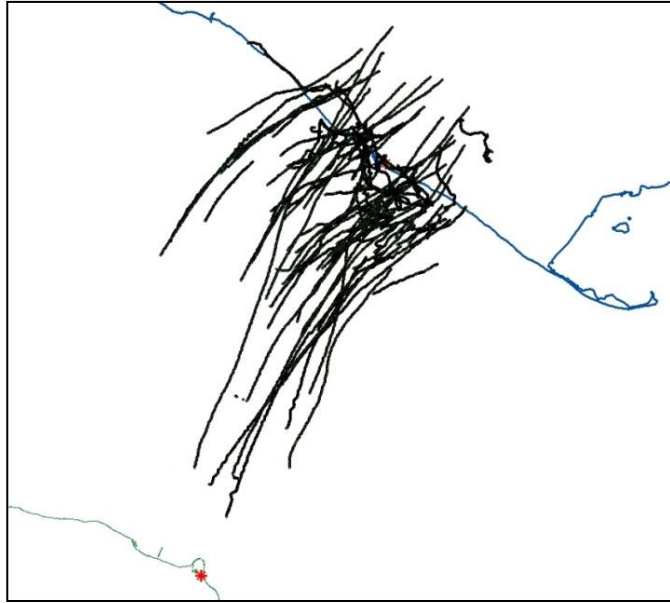

Figure 4.120 Tracks of Wood Pigeons, Rødbyhavn autumn 2009 (n=84). Data from tracking radar "Superfledermaus" were used.

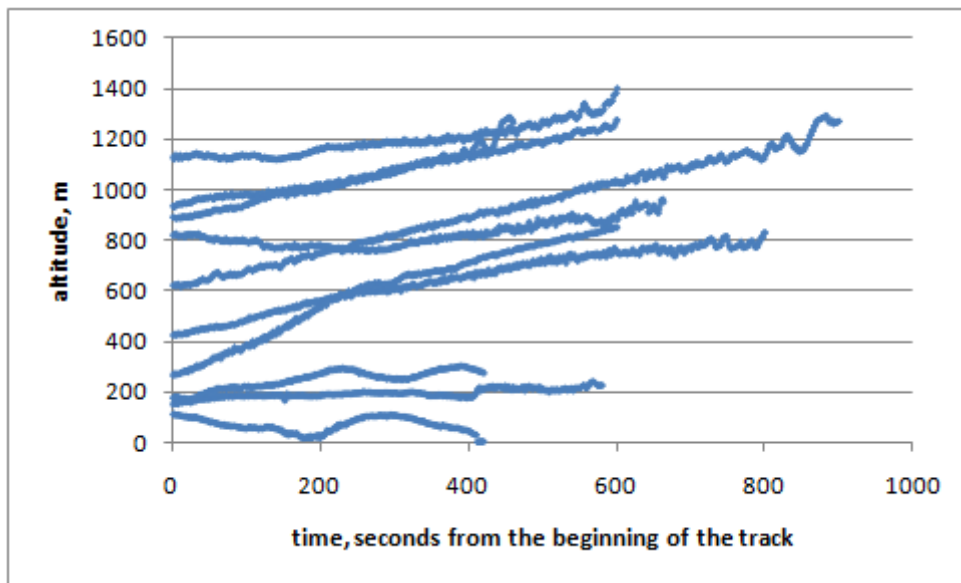

Figure 4.121 Dynamics of altitude change during the migratory flight of Wood Pigeons as recorded at Rødbyhavn during autumn 2009 (example of 10 longest tracks). Data from tracking radar "Superfledermaus" were used.

FEHMARNBELT BIRDS

Yellow Wagtail

While no tracks exist for spring, during autumn 2009 all tracked Yellow Wagtails were recorded flying singly or in small flocks along the coastline and at some point turning south to cross the Fehmarnbelt (Figure 4.122). All but one were tracked flying low over water (Figure 4.123), a typical behaviour for this species during autumn migration.

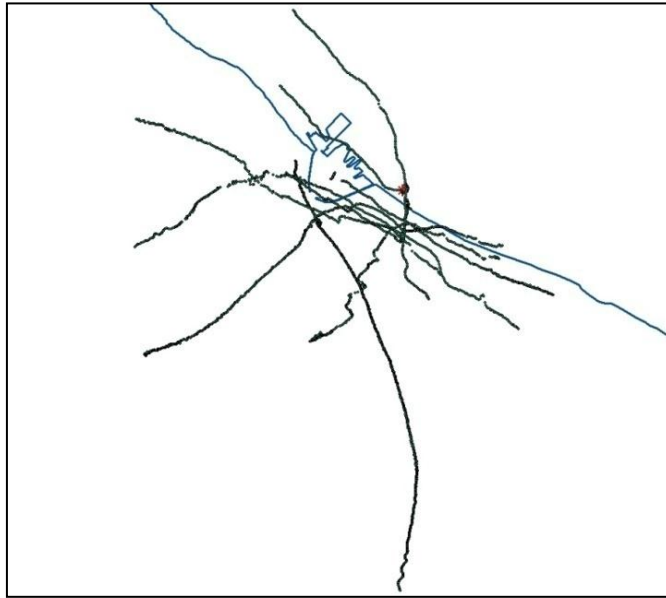

Figure 4.122 Tracks of Yellow Wagtails, Rødbyhavn autumn 2009 (n=9). Data from tracking radar "Superfledermaus" were used.

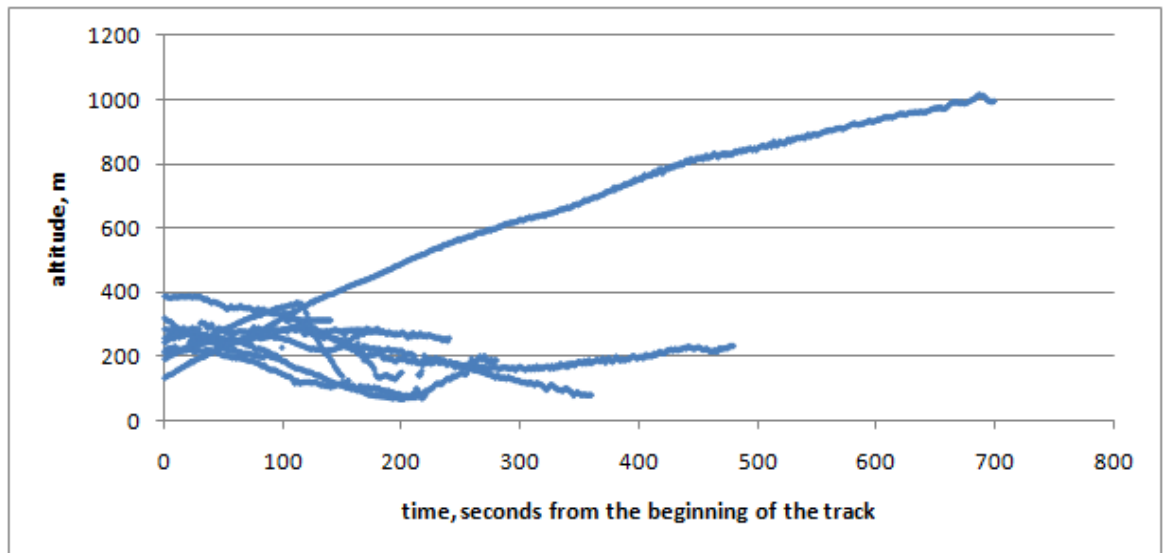

Figure 4.123 Dynamics of altitude change during the migratory flight in Yellow Wagtail, Rødbyhavn autumn 2009 (n=9). Data from tracking radar "Superfledermaus" were used.

FEHMARNBELT BIRDS

Chaffinch

In spring 2009 Chaffinches were observed gliding down towards Lolland while quickly descending (Figure 4.124, Figure 4.125), with tracks rather straight heading towards the coast in comparison to autumn.

Only three flocks of Chaffinches were identified and tracked during autumn migration 2009, but each of them gained height when crossing the Fehmarnbelt. Two out of three tracks indicated that birds were zigzagging close to the coastline when they started to gain height (Figure 4.126, Figure 4.127).

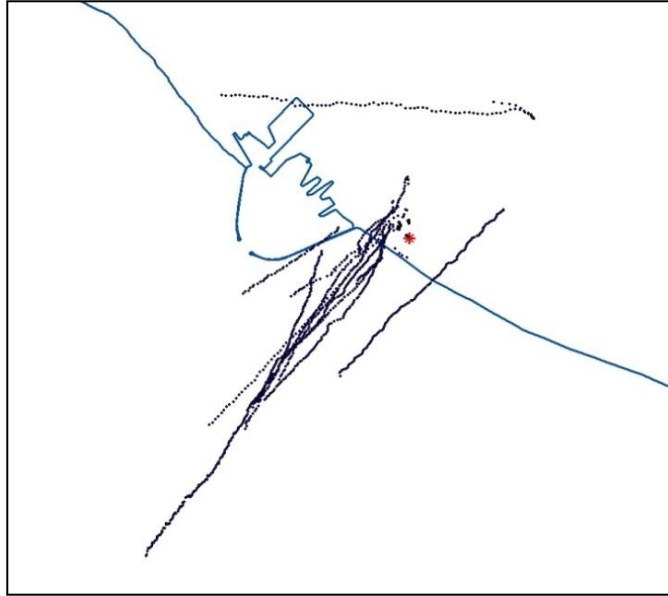

Figure 4.124 Tracks of Chaffinches, Rødbyhavn spring 2009 (n=12). Data from tracking radar "Superfledermaus" were used.

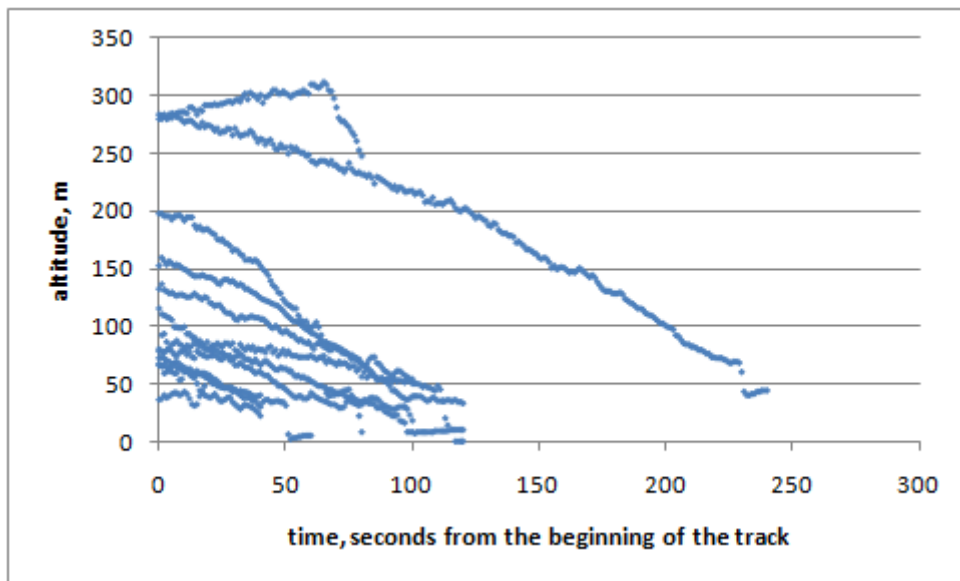

Figure 4.125 Dynamics of altitude change during the migratory flight of Chaffinches (n=12) as recorded in Rødbyhavn in spring 2009 (n=12). Data from tracking radar "Superfledermaus" were used.

FEHMARNBELT BIRDS

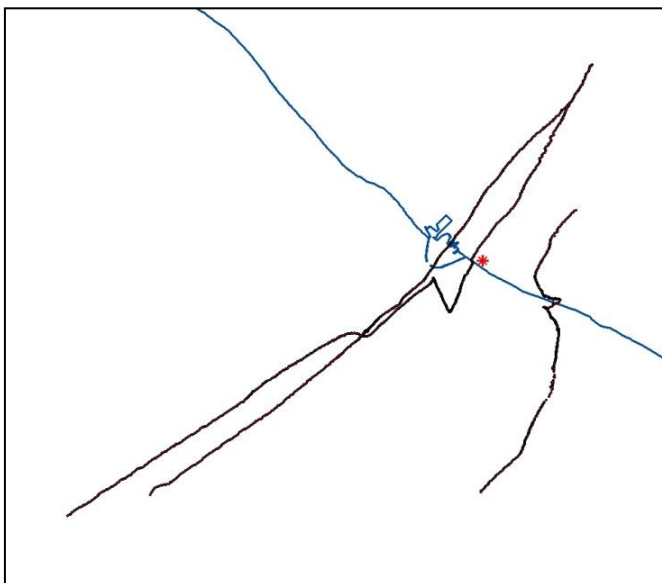

Figure 4.126 Tracks of flocks of Chaffinches, Rødbyhavn autumn 2009 ($n=3$). Data from tracking radar "Superfledermaus" were used.

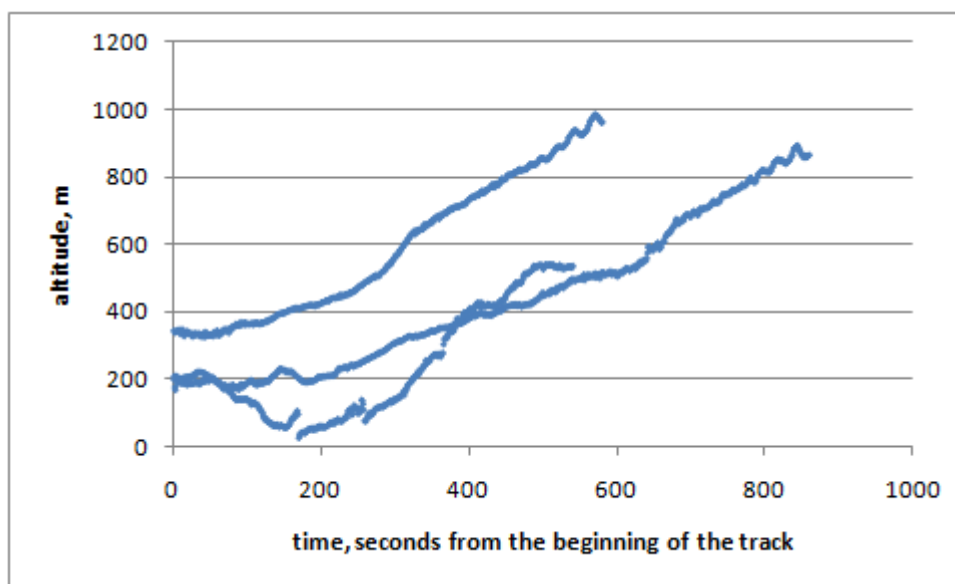

Figure 4.127 Dynamics of altitude change during the migratory flight in Chaffinch flocks as recorded at Rødbyhavn during autumn 2009 (example of 3 tracks). Data from tracking radar "Superfledermaus" were used.

Summary of long track description

Track geometry for spring and autumn was assessed to be dependent on the local weather situation, in particular wind direction and speed. However, it also seems to be specific for individual species, or for groups of species reflecting differences in migration strategy, e.g. for crossing large water bodies.

FEHMARNBELT BIRDS

Some species like Barnacle Goose do not show a behavioural reaction when crossing the coastline both ways, their tracks remain constant with respect to direction and altitude.

This is different for birds of prey. When they arrive at the north coast of the Fehmarnbelt during spring from across the Fehmarnbelt, they glide down towards land and sometimes they arrive in active flight close to ground level. In autumn, when coming from over land and facing the open water on their SW migration, tracks apparently consist of two different phases – gaining height when drifting with the wind and gliding towards the migratory direction. Often this leads to zigzagging tracks, in particular over land.

Wood Pigeons apparently arrive from across the Fehmarnbelt at the coast and continue without a distinct reaction. During autumn they often gain height during their entire flight across the Fehmarnbelt. Some of the flocks were observed to leave Lolland in W/SW direction and then change the flight direction towards Puttgarden.

Different species of small passerines appear to have different strategies for crossing larger water bodies such as the Fehmarnbelt. Yellow Wagtails were often observed following the coastline of Lolland already over water, but most likely within sight of the shoreline and at some point turn south and start crossing the Fehmarnbelt keeping the same altitude. Chaffinches in autumn were recorded to approach the coastline from the north, and once reaching the shoreline to start gaining height and continue over water; they probably descend towards the opposite coast as can be concluded from observations on arriving birds during spring.

Thus, after having described those findings for the different species, it has to be noted, that those flight strategies do also depend on the weather conditions, as e.g. thermals only occur during days with sunshine and low wind speeds. If birds face unfavourable weather situations, they may still migrate but show a different flight pattern, as for example Honey Buzzards and Red Kites in autumn 2009 have been registered to actively fly low over the water during days with strong south-westerly headwinds.

4.6.2 Unidentified tracks – night-time 2009 and 2010

The knowledge about the behaviour of migrating birds during night flights is very limited. Visual observations are not possible, and other devices have to be used to obtain data on migration behaviour, flight paths and altitudes. But even then, species identification is almost impossible even with advanced radar or night-vision technology. There are options to apply additional observation methods including e.g. telemetry, data loggers and other more invasive methods (e.g. Bowlin et al., 2010). In the present study, tracking, pencil beam radar and acoustical observations were used to yield data on night-time migration.

Clearly, at the observation site at Rødbyhavn a substantial variety of water- and landbird species with different migratory habits occur, leading to a large variation of e.g. track directions, altitudes and vertical speeds.

Two types of tracks were available for the study of nocturnal migration. The first type of the night tracks were recorded using an automatic tracking procedure. The unmanned tracking radar searches automatically for objects; once found, objects were followed for 20 seconds. After 20 seconds the target is dropped and another target is automatically searched for. The second type of tracks was

FEHMARNBELT BIRDS

recorded manually. A target was searched, and once found it was followed for an extended time period to obtain long tracks and also wing beat frequencies of the birds. The operator manually tracked echoes during the first 4 hours of the night. During spring, only a few tracks were observed.

Long tracks provide unique information about the geometry of nocturnal tracks for birds which remain invisible for any other observation method. Statistics of vertical speed calculated on the basis of long tracks yielded a reasonable distribution and variation, whereas statistics calculated on the basis of short tracks are more vulnerable for any kind of noise. Therefore, analysis of long tracks was performed. Since initial calculations on the basis of short tracks showed large variabilities, potentially due to the fact that during automatic tracking mode a lot of tracks came from "non-bird" sources such as clutter, ferry exhaust, windmills, and other moving objects. Results were inconclusive and any further analyses stopped.

At Rødbyhavn 2009 only 66 of some 7,000 night-time tracks had longer tracking times during spring, then constituting a dataset too small for a proper analysis. During autumn 2009, some 4,000 night-time tracks were recorded at Rødbyhavn, with 235 of those with longer tracking time, obtained during a period between early of September and mid October (Figure 4.128). The highest vertical speed values, both positive and negative, were obtained for tracks at low altitudes (Figure 4.129). There was no correlation between vertical speed and flight direction detectable (Figure 4.130). Also, vertical speed yielded no clear relationship to wind direction (Figure 4.131).

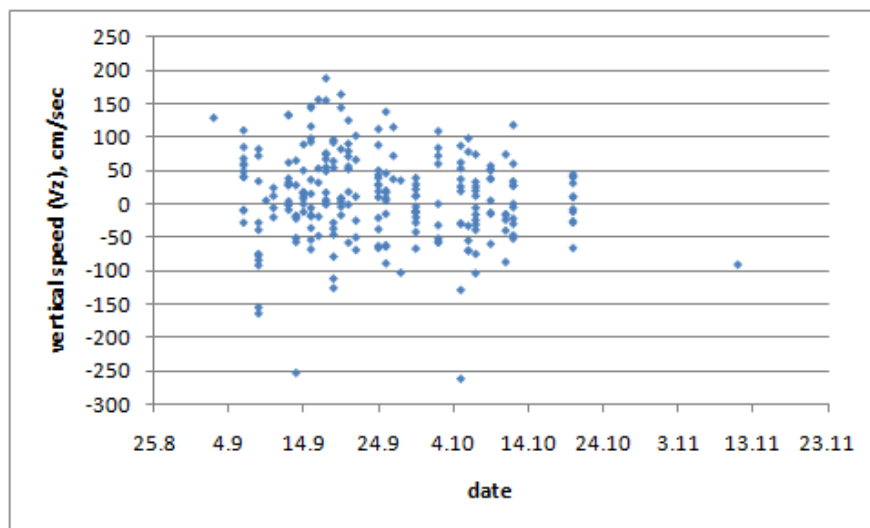

Figure 4.128 Distribution of vertical speed during the autumn migration in Rødbyhavn in 2009 (n=235). Data from tracking radar "Superfledermaus" were used.

FEHMARNBELT BIRDS

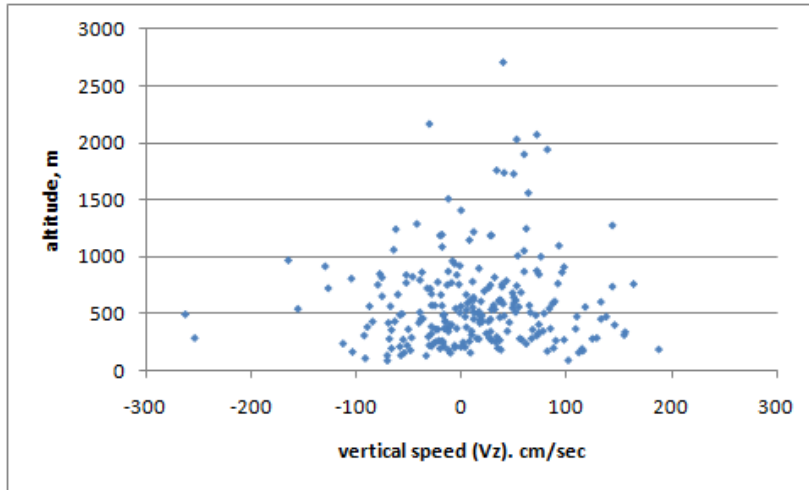

Figure 4.129 Flight altitude distribution in relation to the vertical speed of long tracks during autumn 2009 (n=235). Data from tracking radar "Superfledermaus" were used.

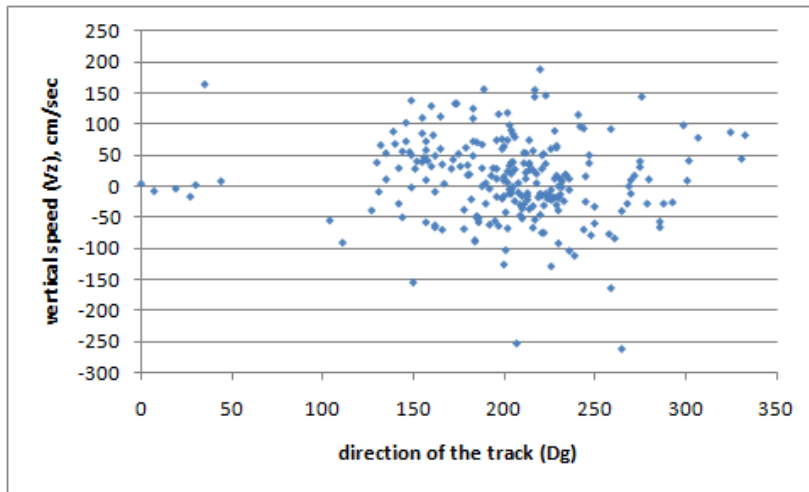

Figure 4.130 Distribution of vertical speed in relation to the directions of the tracks during autumn 2009 (n=235). Data from tracking radar "Superfledermaus" were used.

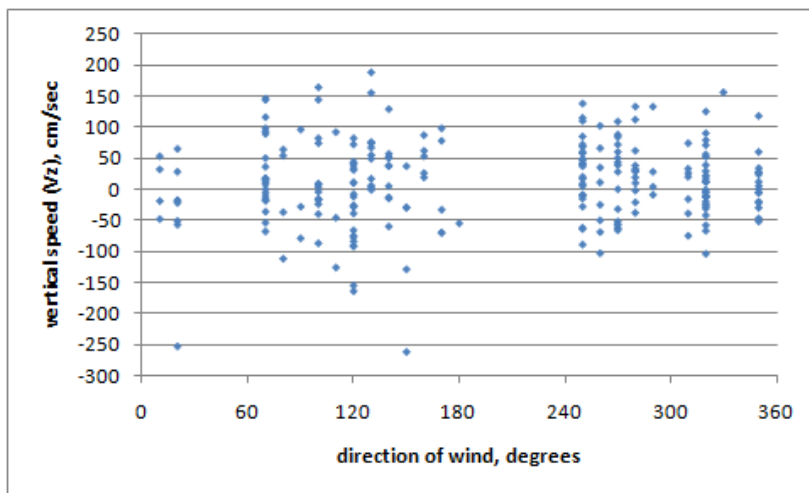

Figure 4.131 Distribution of vertical speed in relation to ground wind direction during autumn 2009 (n=235). Data from tracking radar "Superfledermaus" were used.

FEHMARNBELT BIRDS

During autumn 2010 a total of 2,426 tracks was produced during the first 4 hours after sunset at the Puttgarden location. These tracks were distributed more evenly during the season (Figure 4.132). Also here, highest vertical speeds occurred at low altitudes (Figure 4.133) and track direction seems not to have an influence on vertical speed (Figure 4.134).

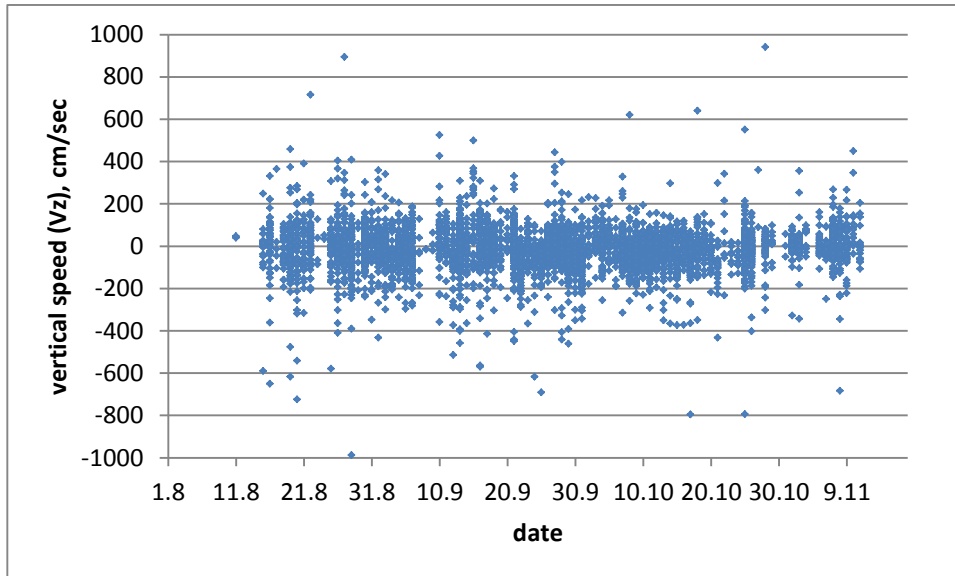

Figure 4.132 Distribution of vertical speed during the autumn migration in Puttgarden in 2010 ($n=2426$). Data from tracking radar "Superfledermaus" were used.

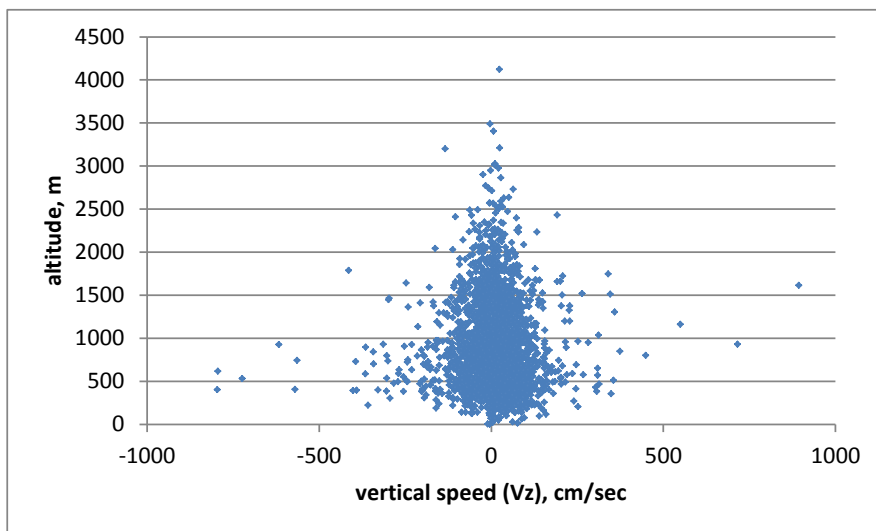

Figure 4.133 Flight altitude distribution in relation to the vertical speed at Puttgarden in autumn 2010. Data from tracking radar "Superfledermaus" were used.

FEHMARNBELT BIRDS

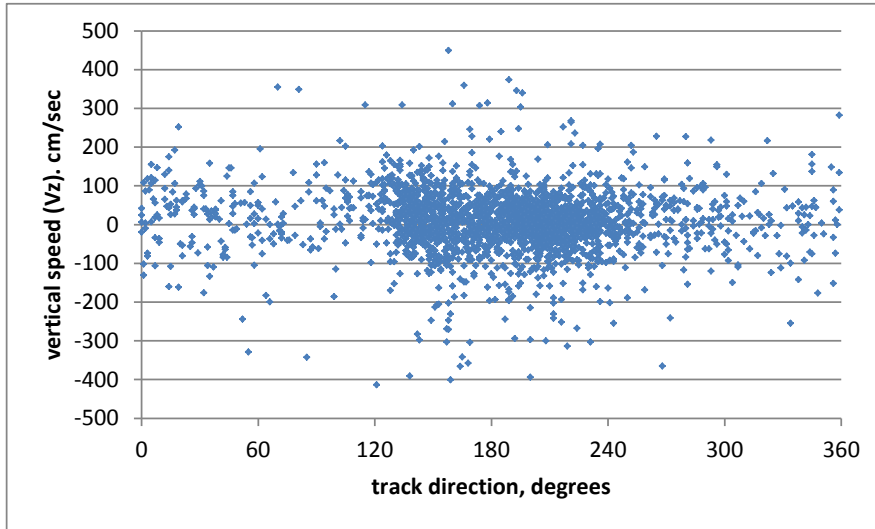

Figure 4.134 Distribution of vertical speed in relation to the directions of the tracks at Puttgarden during autumn 2010. Data from tracking radar "Superfledermaus" were used.

With regard to wind direction, no apparent dependency can be seen (Figure 4.135). However, statistic results suggest that tracks tend to ascend under the wind blowing from W-NNE directions between 250 and 20 degrees, but no clear pattern could be seen for the rest of wind directions (Figure 4.136). This tendency may reflect a migratory strategy where birds try to avoid wind drift towards the Atlantic Ocean crossing Western Europe (see Thorup et al., 2003 for the region specific wind drift).

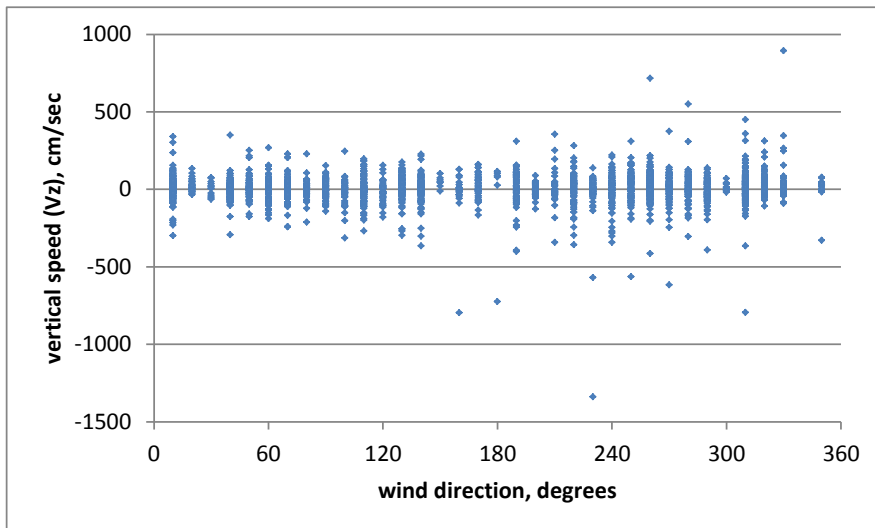

Figure 4.135 Distribution of vertical speed in relation to ground wind direction at Puttgarden in autumn 2010. Data from tracking radar "Superfledermaus" were used.

FEHMARNBELT BIRDS

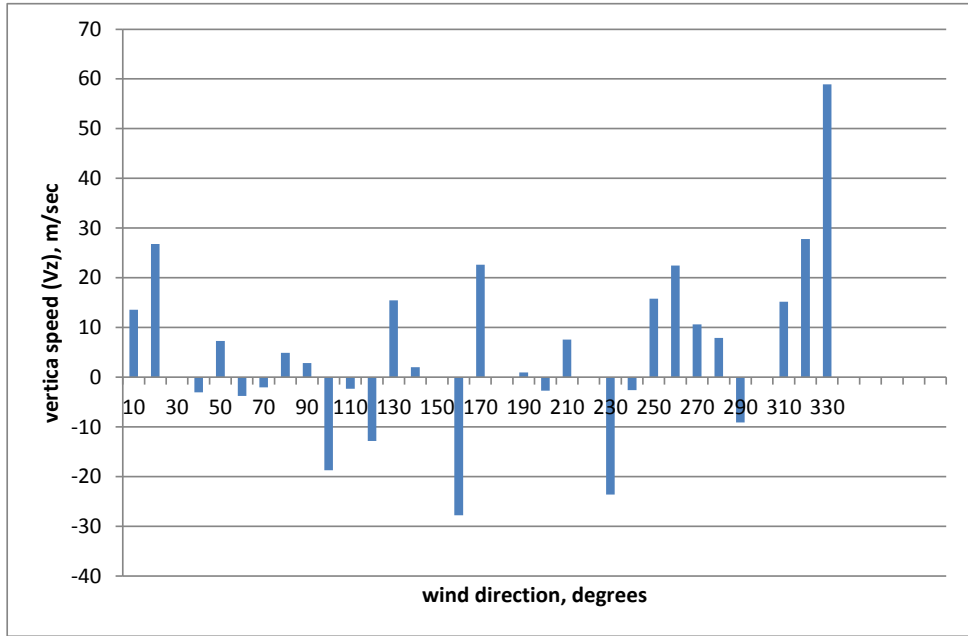

Figure 4.136 Mean vertical speed of the tracks in relation to ground wind direction, nocturnal manual tracks, autumn 2010 (data points with n less 20 tracks in a group were erased). Data from tracking radar "Superfledermaus" were used.

Table 4.23 shows the mean vertical speed of tracks in relation to time during the beginning of the night and cloud cover score. Tracks tend to ascend during the first hours of the night, especially when the cloud cover is low. Nocturnal migrants begin their migratory flights at the beginning of the night, but a proportion of birds also descends which indicates the complexity of the system and a mixture of species and individuals with different migratory state.

Table 4.23 Mean vertical speed (V_z) in relation to time of the observation (UTC) and cloud cover, autumn 2010, manual nocturnal tracks. Values calculated with less than 20 tracks were erased.

Hours (UTC)	Cloud cover score								
	0	1	2	3	4	5	6	7	8
19	14.546	26.078	9.2105	-26.05	10	4.8478	46.522	4.4085	-2.184
20	-0.639	2.1818	3.7869	-4.213	-7.472			16.847	14.397
21	11.161	-1.937	27.435	11.529	1.1176			8.392	-0.283
22	-3.05								-1.304

The cloud cover is known to have an effect on the take off behaviour of nocturnal migrants. Interesting to note that quite developed clouds seem to be stimulating more steep ascending (Figure 4.137).

FEHMARNBELT BIRDS

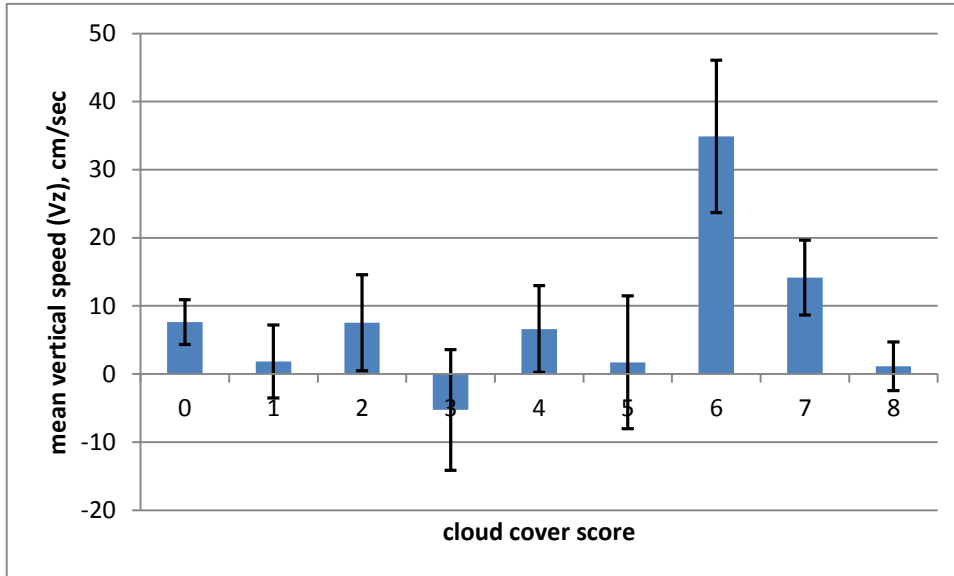

Figure 4.137 Mean vertical speed (V_z) in relation to the cloud cover, nocturnal tracks, autumn 2010, bars indicate SE. Data from tracking radar "Superfledermaus" were used.

Another factor affecting the normal migratory flight is visibility (Table 4.24). During very good visibility conditions birds ascend, when the conditions are getting worse birds tend to land. The lowest visibility in 2010 ranged between 2,100 and 4,000 m, there were no tracks measured when visibility was below 2,100 m due to too few birds aloft. However, with the lowest visibility birds tended to ascend. This result might be explained by the bias of a too small sample size, or by speculation that very low visibility potentially stimulates birds to ascend probably to avoid the collision with ground objects or landing in unacceptable biotopes (or on water for land birds). This avoidance behaviour could be seriously disrupted by illuminated objects. It is a well known phenomenon that light attracts masses of nocturnal migrants during foggy nights with limited visibility, under these conditions light acts as the only source of the visual orientational information and thus disrupts normal migratory behaviour.

Table 4.24 Relation of mean vertical speed (V_z) and visibility conditions.

Visibility	V_z , m/sec	n
<4,000 m	6.5	74
4,000 -11,000 m	-10.1	359
>11,000 m	17.3	1935

Ascending tracks

In 2009 61 out of 235 long nocturnal departure tracks at Rødbyhavn were identified as ascending with a vertical speed of more than 50 cm/sec. Tracks marked by red arrows in Figure 4.138 were tracked at the altitudes 184, 229 and 274 m which are close to lowest possible altitude of track detection range by the tracking radar. All three tracks were heading towards S and displayed ascending vertical speeds of 62, 115 and 56 cm/sec, respectively (Figure 4.138, Figure 4.139). Tracks were often observed not to be linear, but zigzagging when gaining height. Most likely this reflects the take-off behaviour of the birds. Highest values of ascending speed were recorded for the low altitudes (Figure 4.129). Consequently, the vertical speed V_z within the range 50–280 cm/sec was

FEHMARNBELT BIRDS

significantly and negatively correlated with the altitude of the beginning of the track (Spearman $r = -0.311$, $p=0.015$) (Figure 4.141).



Figure 4.138 Map of the nocturnal long tracks ascending with the vertical speed > 50 cm/sec as recorded at Rødbyhavn during autumn 2009 ($n=61$). Three red arrows indicate the three lowest tracks (altitude < 275 m), which are non-linear as compared to most other tracks at higher altitudes; red asterisk marks the position of the tracking radar in Rødbyhavn. Data from tracking radar "Superfledermaus" were used.

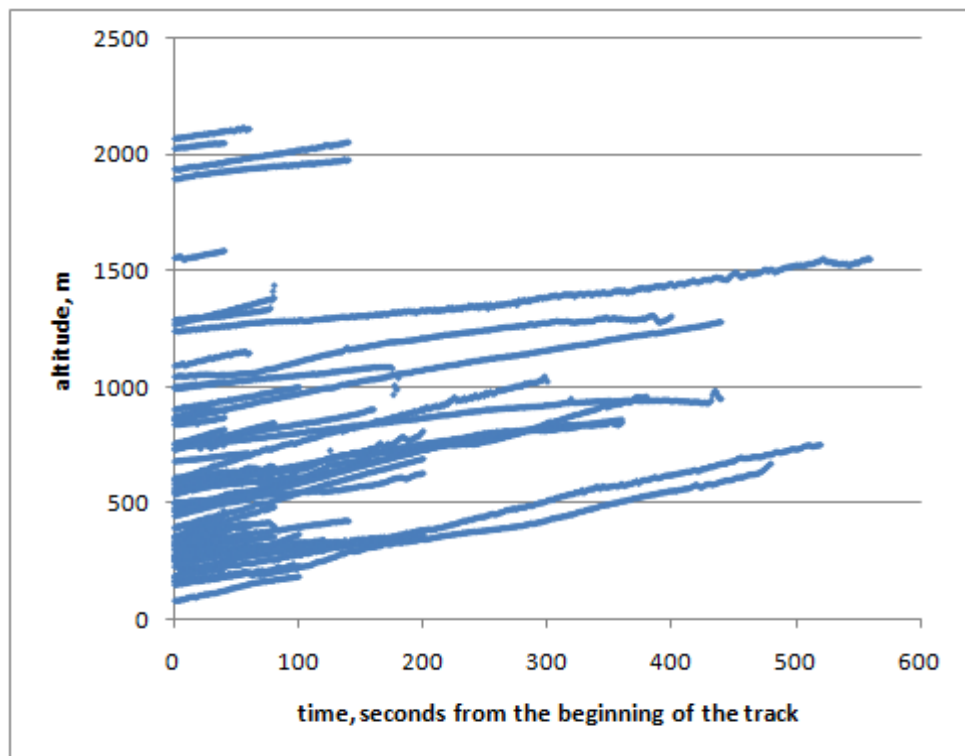

Figure 4.139 Dynamics of altitude change for tracks from Figure 4.138. Data from tracking radar "Superfledermaus" were used.

FEHMARNBELT BIRDS

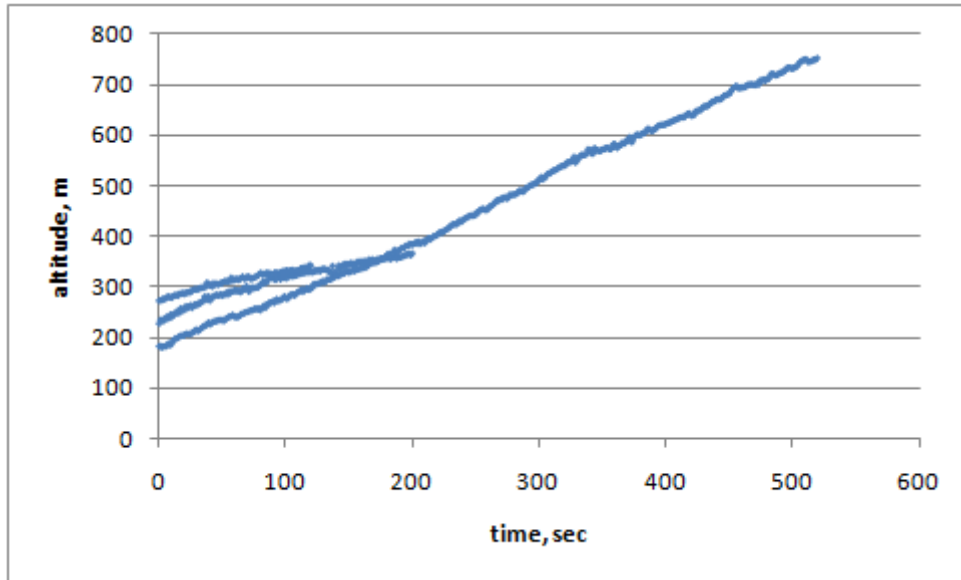

Figure 4.140 Dynamics of altitude change for the 3 tracks marked by red arrows in Figure 4.138 ascending and zigzagging at low elevations. Data from tracking radar "Superfledermaus" were used.

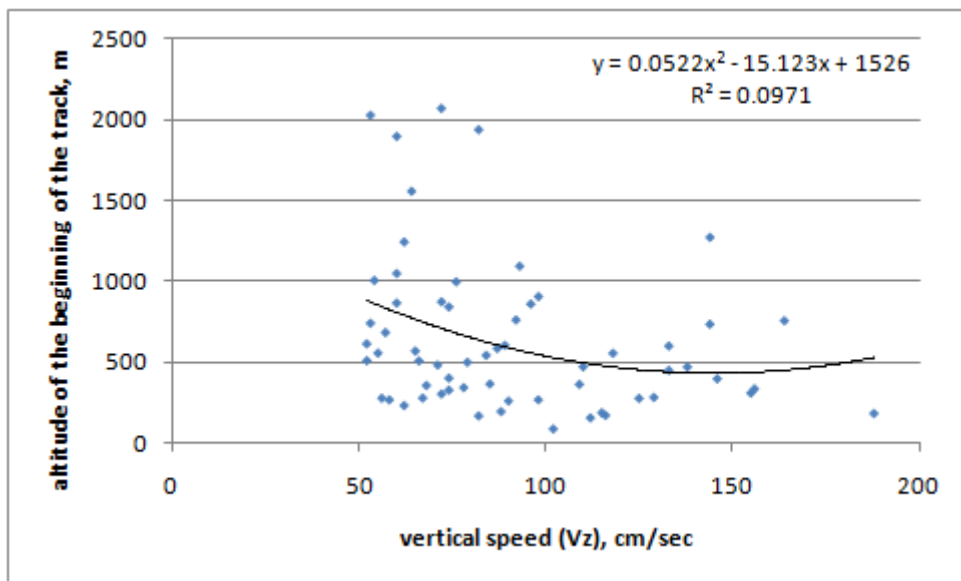

Figure 4.141 Relation between vertical speed and the altitude of the same tracks as shown in Figure 4.138. Data from tracking radar "Superfledermaus" were used.

In autumn 2010 (arrival coast), 599 tracks were identified as ascending at Puttgarden. The spatial distribution of these tracks does not show a clear pattern, both ascending and descending tracks show a circular distribution around the location of the radar (Figure 4.142). Unlike in 2009, the values of vertical speed also do not depend on the altitude of the beginning of the track (Figure 4.143).

FEHMARNBELT BIRDS

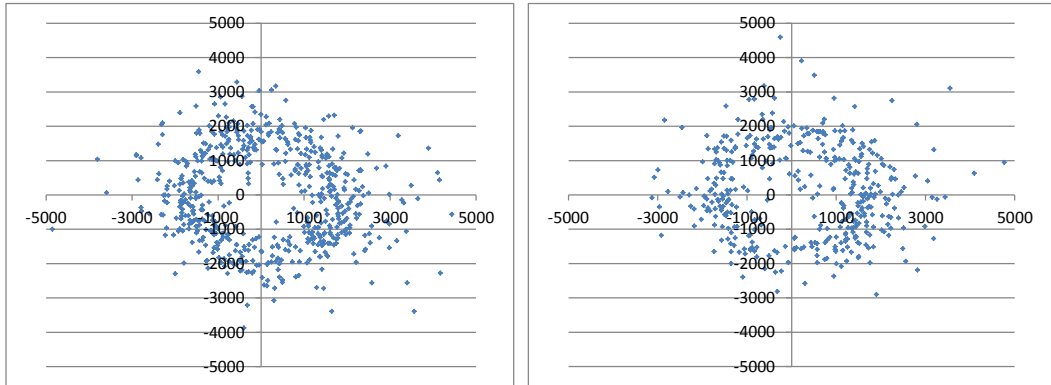

Figure 4.142 Distribution of descending ($<-50\text{ cm/sec}$, left) and ascending ($>50\text{ cm/sec}$, right) tracks around the radar at Puttgarden in autumn 2010. Axes are in meters. Axes are in [m], coordinate system is oriented N. Data from tracking radar "Superfledermaus" were used.

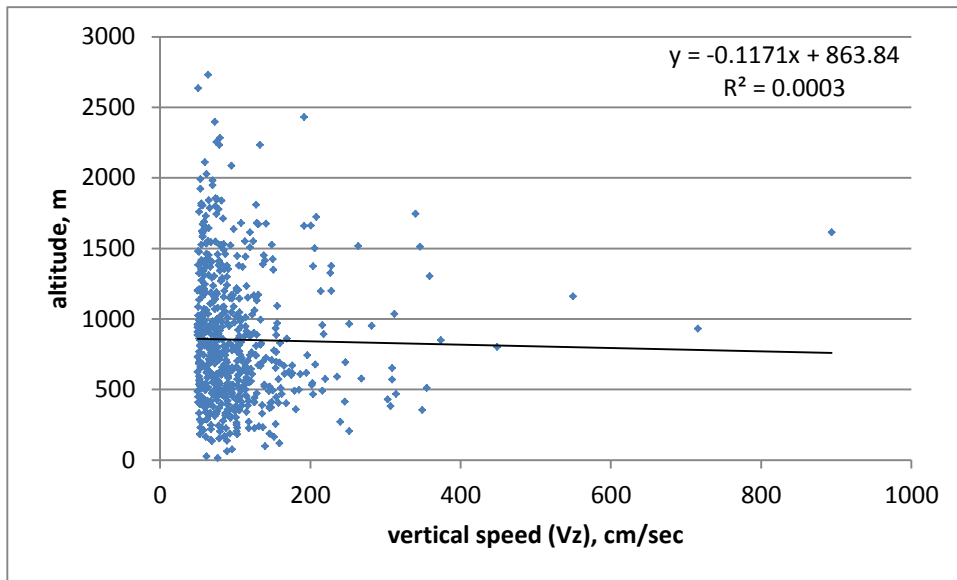

Figure 4.143 Relation between vertical speed and the altitude, night ascending tracks autumn 2010 ($n= 599$). Data from tracking radar "Superfledermaus" were used.

When taking off birds do not necessarily have to ascend quickly. For example, the GPS/satellite telemetry of Bar-headed Geese crossing the Himalaya shows that the vertical ascending speed of this species is $0.8 - 2.2\text{ km/hour}$ ($22 - 61\text{ cm/second}$) (Hawkes et al., 2011). Even more, it was shown, that when climbing these geese do not use the favourable weather conditions such as updrafts, and prefer to maximize the control over the flight rather than to wait for help from wind direction. In the present study birds were categorized as ascending only when positive $V_z > 50\text{ cm/s}$, and as descending when negative $V_z < 50\text{ cm/s}$, in order to clearly separate those different flight phases. However, the exclusion of all low vertical speeds may weaken statistical power. Furthermore, since Puttgarden during autumn represents an arrival coast, a mixture of vertical speeds was assumed from birds arriving from across the sea,

FEHMARNBELT BIRDS

birds continuing flight with no altitude change and birds ascending when reaching the coast or when starting their flight.

Descending tracks

Out of 235 long nocturnal tracks recorded at Rødbyhavn in autumn 2009 (departure coast), 38 were classified as descending with a negative speed faster than -50 cm/sec (Figure 4.144, Figure 4.145). Sometimes tracks descended quickly, both above water and above ground, sometimes tracks showed a zigzag pattern (Figure 4.144).

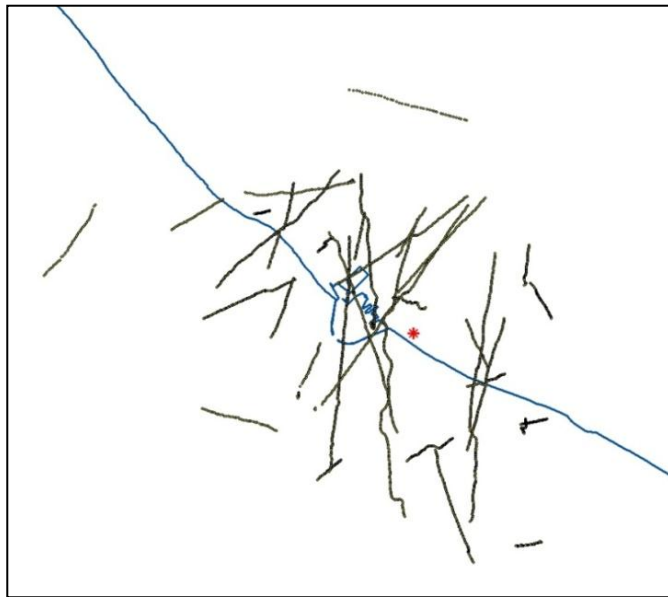

Figure 4.144 Map of descending night-time tracks with the vertical speed < -50 cm/sec as recorded at Rødbyhavn in autumn 2009 ($n=38$).

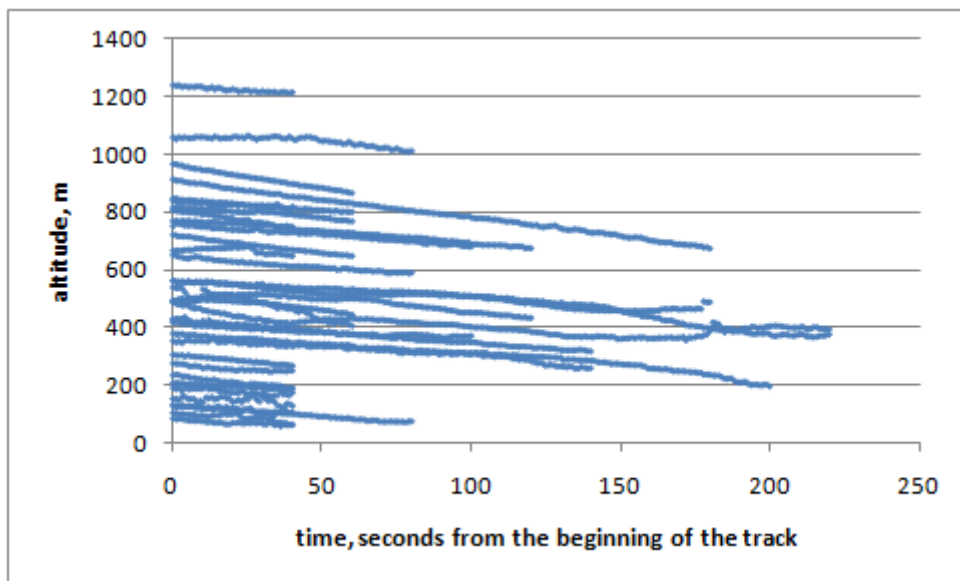

Figure 4.145 Dynamics of altitude change for descending tracks from Figure 4.144.

FEHMARNBELT BIRDS

There are various natural reasons for migratory birds to descend, even at the departure coast before crossing large water bodies e.g. due to depletion of energy resources at the temporal end of a migratory flight, reaching of coastline, time of day (sunrise or sunset depending on migration strategy) etc. or due to adverse weather conditions.

Figure 4.146 shows the relation between descending speed and cloud cover. There is a tendency for the birds to descend faster when the sky is covered by clouds. However, this relation is not statistically significant.

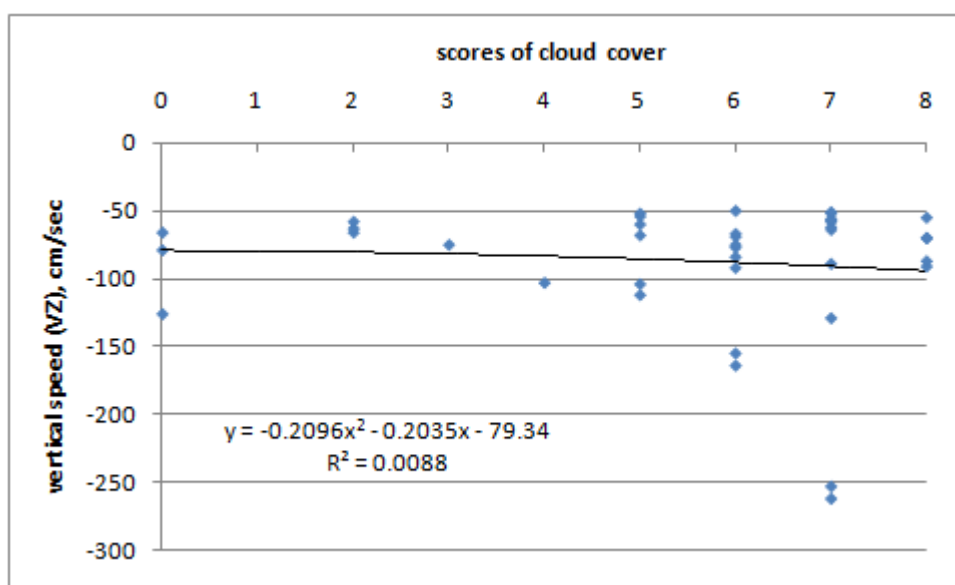

Figure 4.146 Relation between descending vertical speed and cloud cover as observed for long night-time tracks recorded at Rødbyhavn in autumn 2009 (n=38).

In autumn 2010 (arrival coast), 414 tracks were identified as descending at Puttgarden. The spatial distribution of these tracks around the radar does not seem to have a clear pattern (Figure 4.142). There was a tendency to have a higher descending speed at the lower altitudes (Figure 4.147). As birds arrive from across the sea, they may approach the coast as well as topographic features on the coasted descending from a certain altitude, or they may continue without changing altitude; the latter may occur at higher altitudes at which birds migrate in a broad-front and disregarding topographical features beneath.

After all, it proved to be very difficult to come out with clear conclusions from these night-time tracks. This may be due to the fact, that without species identification, these samples of tracks can contain different species with different migration strategies and behaviour, and may also depend on different weather conditions. In addition, no tracking is possible in inclement weather, e.g. rain, thus those conditions could not be tested.

FEHMARNBELT BIRDS

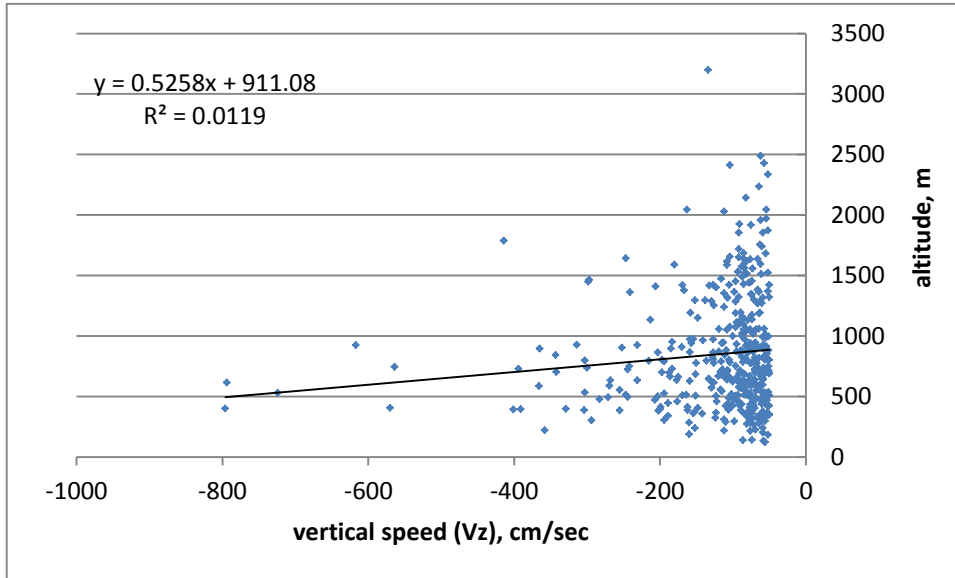

Figure 4.147 Relation between vertical speed and the altitude, night descending tracks, autumn 2010.

5 BIRD MIGRATION AND WEATHER

Every bird species has its own individual strategy of migration. This strategy is based on physiological and ecological adaptations of this species which define the specific timing of migration and selection of favourable environmental parameters such as weather conditions and stop-over locations. Migration is under strong control from endogenous programmes which dictate the time frame for the migration (Gwinner 1986, Berthold 1996, Ramenofsky and Wingfield 2007). However, this time frame will also be influenced by actual migration conditions, which are dependent on weather conditions. Long distance migrants naturally spend more time on migration, and therefore arrive later in spring and begin autumn migration earlier as compared to short distance migrants (Berthold 1996, 2001). Consequently, long distance migrants have very detailed programmes controlling the start, the course and the end of migration (Berthold et al., 2003). Short distance migrants have more flexible programmes in general, migrate later in the seasons and tolerate more variable weather conditions. During favourable conditions populations may be partially migratory, or may even become sedentary (Lundberg 1988, Berthold 1996, 2001).

These complex systems of bird migration are far from being completely understood. However, it is possible to identify separate ecological groups (see chapter 1). Among these species registered with high numbers during our investigations are selected, representing a generalised strategy and behaviour. The groups are:

1. Waterbirds preferentially migrating over water - seaducks, pelagic species etc.-
– here Common Eider
2. Waterbirds less reliant migrating over water – geese, waders – with migration preferences steered by destination and stop-over sites
– here Barnacle Goose
3. Landbirds migrating during daytime - depending on updrafts / thermals
– here Common Buzzard; passerines – here Tree Pipit and Greenfinch
4. Landbirds migrating over a broad-front during night-time
– no species selected, as no visual observations exist.

In the following chapters the relationship between weather and bird migration will be further explored using baseline data from the Fehmarnbelt region; this shall help to understand a) the variation in bird migration at the Fehmarnbelt caused by medium and short-term weather conditions, b) the conditions, which may influence the temporal and spatial distribution of local bird migration at the link. These are important issues to be considered when assessing potential risks, as for example collision risk will strongly vary with weather conditions.

5.1 Bird migration behaviour and wind – visual observations

5.1.1 Introduction

Landbirds arriving at the Fehmarn coast in spring and at the Lolland coast in autumn will have to choose between departing the land mass and crossing the Fehmarnbelt or following the coastline. The results of the visual observations, real-time tracks and screenshot data clearly document that large numbers of landbirds depart land from Puttgarden and Rødbyhavn during spring and autumn, respectively. However, the tendency to either depart at these two locations or to follow the coast and depart beyond the range of own investigations during the two baseline years likely depends on the wind conditions.

The hypothesis is that birds follow the coast as long as crossing depending on the wind conditions will not be economic. The lack of ability in migrating landbirds to compensate for wind drift in particular over the sea has been suggested as a major determinant for the birds' choice of departing or coasting (Alerstam & Petterson (1977)). While landbirds can compensate efficiently for wind drift over land they have a tendency to get wind drifted over the sea. Thus, they will tend to follow the coast during unfavourable winds like head winds and strong cross winds, whereas they would choose to leave the coast and cross during tail winds and weak cross winds. Coastal migration would be expected if drift towards the shore exceeds the angle between the birds' preferred track direction and the coastline (Alerstam and Petterson 1977).

An analysis of the coasting/crossing (departing) behaviour of migrating landbirds in Puttgarden during spring and in Rødbyhavn during autumn was carried out. The objective of this analysis was to investigate the effect of wind conditions on both the migration intensity and behaviour (coasting/departing) of migrating landbirds during 2009 and 2010, using results from the visual observations.

Unlike Rødbyhavn and Puttgarden, locations on headlands may represent points where the birds will eventually have no choices left, and will cross in large numbers even during unfavourable winds. Famous points like this are e.g. Falsterbo, Sweden. Those points serve as culmination points.

Waterbirds, on the other hand, due to their preference for flying over water will be funnelled through the Fehmarnbelt, and may get drifted towards the coastal areas due to the wind-related displacement by onshore winds (Meltøfte and Rabøl 1977, Krüger and Garthe 2002). The tendency to fly closer to the coastline under strong onshore winds may be augmented by the lower wind speeds close to the coast in comparison with that over the open sea (Alerstam and Petterson 1977). This so-called leading line effect may be strongest for species of waterbirds which migrate at low altitude (Meltøfte 2008). The hypothesis, that the distance of migrating waterbirds to the coasts of the Fehmarnbelt decreases during onshore wind conditions, was tested. The objective was to investigate the effect of wind conditions on the average distance of migrating waterbirds to the coast during 2009 and 2010 using counts and distance measurements from the visual observations.

5.1.2 Migration intensity and directions in dependence of wind

For the analyses of bird migration intensities in dependence of wind, the 20 most abundant species of land birds were selected for analyses. For Puttgarden this species list contains 3 birds of prey species, Common Swift, Wood Pigeon and Stock Dove plus 14 species of day migrating songbirds, among them Jackdaw as a larger species. For Rødbyhavn this species list contains 4 birds of prey species, Common Swift and 15 species of day migrating songbirds, among them again Jackdaw.

For the analyses of the distance to the coast with regard to waterbird migration distance under different wind conditions, only events including more than 10 individuals of a species have been used, and only for those species, for which 10 days of data are available. This reduced sample size to 2, including only Common Eider and Common Scoter.

The results of the Kruskal-Wallis tests for the visual observations in Puttgarden in spring are shown in Table 5.1 to Table 5.3 and in boxplots in Appendix A.8, figures A.21 to A.23, and for Rødbyhavn in autumn in Table 5.4 to Table 5.6 and Appendix A.8, figures A.24 to A.26. Boxplots are shown only for those species for which the test was statistically significant ($p < 0.05$).

FEHMARNBELT BIRDS

The Kruskal-Wallis test indicates overall, whether the responses (migration intensity, coasting/departing) between the wind categories were significantly different from each other. Mean ranks of wind components are shown as the sums of ratings of all combinations of day-wind component divided by the sample size. P values for significant results of multiple pairwise comparisons between wind components are given to provide information on significant differences between pairs of wind components. These are shown for the component with the higher rank by the p values and the name of the compared component.

Migration intensities during spring at Puttgarden (Table 5.1, Appendix A.8, figures A.21):

17 species had sufficient sample sizes for the Kruskal-Wallis test. Only 5 of 17 species were tested significant: Linnet, Wood Pigeon, Chaffinch, White Wagtail and European Starling. This means that for these species migration intensities as recorded by visual daytime observations are different during different wind situations. This also means that for 15 species wind seems not to influence migration intensity, significantly.

In detail, Linnet, Chaffinch and European Starling had the highest migration intensities during easterly cross winds, and for Linnet and Chaffinch this is significant in comparison to migration intensities during head wind. Wood Pigeon had highest migration intensities during tail wind, followed by easterly cross winds, both significantly different from head wind situations.

Table 5.1 Summary of Kruskal-Wallis ANOVA by ranks – migration intensity at Puttgarden during spring 2010 for different wind components. Valid sample size (Valid N), p value of test (K-W test). Mean ranks of wind components and p values for significant results of multiple comparisons between wind components are given. For exact definitions of wind components see text.

Migration Intensity for Spring Season						
Species	Valid N	K-W test	Side E	Tail	Side W	Head
European Sparrowhawk	76	0.20	38.75	47.72	33.74	35.94
Skylark	54	0.09	23.00	33.47	29.78	15.80
Meadow Pipit	82	0.61	43.58	46.35	37.78	39.41
Tree Pipit	38	0.43	14.33	24.43	19.72	18.42
Common Swift	49	0.68	25.10	20.00	27.10	23.5
Linnet	69	0.02	42.35 (p 0.015-Head)	38.56 (p 0.08-Head)	32.61	18.06
European Goldfinch	45	0.25	24.26	20.95	27.13	14.58
Eurasian Siskin	57	0.53	28.28	32.29	30.43	21.75
Marsh Harrier	52	0.25	32.23	30.90	22.74	23.94
Wood Pigeon	78	0.02	44.14 (p 0.06-Head)	47.63 (p 0.02-Head)	36.21	21.22
Jackdaw	55	0.41	26.76	33.31	28.08	20.93
House Martin	41	0.08	11.16	21.42	24.31	22.89
Chaffinch	82	0.04	48.59 (p 0.06-Head)	47.71	38.45	25.82
Barn Swallow	59	0.32	23.36	30.70	34.31	27.32
White Wagtail	65	0.02	38.79	41.13 (p 0.06-Side W)	24.68	27.56
Yellow Wagtail	8	0.26	18.78	21.39	28.77	21.90
European Starling	76	0.06	47.66 (p 0.04-Head, p 0.1-Side W)	47.62	32.10	24.80

FEHMARNBELT BIRDS

At Puttgarden, birds may follow the coast. Based on the visual observations this is most likely to happen from the SE to NW. They can follow this coasting approach either until they reach the end of the N-coast at Westermarkelsdorf (NW) or Staberhuk (SE) or they culminate at Puttgarden and “decide” to cross from here.

Coasting vs. crossing in spring at Puttgarden (Table 5.2, Appendix A.8, figures A.22):

Six species had sufficient sample sizes for the Kruskal-Wallis test. Regarding coasting, 6 out of 6 species were tested significant. The percentage coasting is different for different wind situations. For all 6 species, the highest coasting proportions occurred during westerly cross winds, whereas the proportions coasting are lowest during easterly cross winds. These species are European Sparrowhawk, Meadow Pipit, Linnet, Chaffinch, Barn Swallow, White Wagtail.

The results for Puttgarden in spring indicated higher migration intensities for a few species during tail wind and easterly cross winds. Most species with sufficient sample sizes displayed significant differences with respect to the proportion of birds coasting, with pair-wise comparisons showing that the tendency for coastal movements were clearly higher during westerly cross winds.

With regard to departing, ten species had sufficient sample sizes for the Kruskal-Wallis test; significant results from Puttgarden were few, and contrary to expectation most birds seem to depart during head winds (Table 5.3, Appendix A.8, figures A.23).

Table 5.2 Summary of Kruskal-Wallis ANOVA by ranks – proportion coasting migrants at Puttgarden during spring 2010 for different wind components. Valid sample size (Valid N), p value of test (K-W test), Mean ranks of wind components and p values for significant results of multiple comparisons between wind components are given. For exact definitions of wind components see text.

Coasting in Spring Season						
Species	Valid N	K-W test	Tail	Side E	Head	Side W
European Sparrowhawk	29	0.04	16.94	8.06	13.67	19.67 (p 0.03 Side E)
Meadow Pipit	53	<0.01	30.07 (p 0.02 Side E)	13.07	18.50	37.8 (p 0.03-Head, p 0.000007-Side E)
Linnet	57	<0.01	29.92	17.97	30.35	40.0 (p 0.0004-Side E)
Chaffinch	63	0.0001	32.88	18.63	28.00	44.76 (p 0.00004-Side E)
Barn Swallow	45	0.003	20.69	13.50	15.85	30.83 (p 0.02-Head, p 0.02-Side E)
White Wagtail	40	0.01	22.00	13.82	17.60	29.65 (p 0.006-Side E)

FEHMARNBELT BIRDS

Table 5.3 Summary of Kruskal-Wallis ANOVA by ranks – proportion departing migrants at Puttgarden during spring 2010 for different wind components. Valid sample size (Valid N), p value of test (K-W test), Mean ranks of wind components and p values for significant results of multiple comparisons between wind components are given. For exact definitions of wind components see text.

Departing in Spring Season						
Species	Valid N	K-W test	Side W	Head	Side E	Tail
Meadow Pipit	56	0.09	29.76	42.86 (p 0.008-Tail)	30.18	19.25
Common Swift	36	0.01	14.06	26.94 (p 0.016-Side W)	23.38	15.4
Linnet	58	0.21	34.88	23.43	31.00	24.33
Wood Pigeon	61	0.06	26.32	22.80	38.95	30.53
Jackdaw	47	0.69	24.43	26.30	25.83	20.21
Chaffinch	65	0.56	30.59	40.50	34.63	31.21
Barn Swallow	45	0.76	21.95	24.65	26.71	20.31
White Wagtail	44	0.19	23.46	21.20	26.66	16.27
Yellow Wagtail	32	0.14	14.55	23.60	20.88	12.90
European Starling	55	0.01	21.48	43.10 (p 0.04-Side W)	33.77	26.21

Migration intensities in autumn at Rødbyhavn (Table 5.4, Appendix A.8, figures A.24):

20 species had sufficient sample sizes for the Kruskal-Wallis test. Only 2 out of 20 species (Sparrowhawk and Siskin) were tested significant; this means, that wind direction seems to have limited influence on the number of birds recorded at Rødbyhavn. Again, Common Buzzard is almost significant.

Table 5.4 Summary of Kruskal-Wallis ANOVA by ranks – migration intensity at Rødbyhavn during autumn 2010 for different wind components. Valid sample size (Valid N), p value of test (K-W test), Mean ranks of wind components and p values for significant results of multiple comparisons between wind components are given. For exact definitions of wind components see text.

Migration Intensity for Autumn Season						
Species	Valid N	K-W test	Side E	Head	Side W	Tail
European Sparrowhawk	93	<0.01	39.45 (p 0.039-Tail, p 0.006-Tail)	38.09	52.94	62.43
Skylark	46	0.10	21.73	18.00	21.19	31.12
Meadow Pipit	71	0.13	33.85	29.63	46.27	36.18
Tree Pipit	50	0.69	29.77	25.05	25.50	22.75
Common Buzzard	63	0.06	31.36	21.96	30.00	39.43 (p 0.047-Head)
Linnet	65	0.07	43.00	24.58	33.38	34.34
European Goldfinch	51	0.79	29.15	27.13	24.92	23.94
European Greenfinch	62	0.23	33.00	34.11	36.31	24.55
Eurasian Siskin	74	0.07	48.031 (p 0.046-Head)	28.05	36.83	37.67
Marsh Harrier	46	0.49	19.28	22.55	29.29	25.15
Jackdaw	55	0.12	27.00	23.07	36.67	25.46
Reed Bunting	56	0.22	31.03	18.61	27.96	31.75
Common Kestrel	51	0.17	20.96	23.17	27.13	32.96

FEHMARNBELT BIRDS

Migration Intensity for Autumn Season						
Species	Valid N	K-W test	Side E	Head	Side W	Tail
Chaffinch	52	0.90	24.30	28.59	26.31	25.58
Barn Swallow	72	0.04	35.79	28.56	39.58	47.18 (p 0.026-Head)
Common Crossbill	42	0.14	26.00	22.72	24.67	15.46
White Wagtail	67	0.34	34.96	28.86	33.36	40.08
Grey Wagtail	47	0.40	23.64	18.70	29.00	24.13
Yellow Wagtail	60	0.10	28.96	35.54	32.75	21.767
European Starling	70	0.20	41.21	26.78	34.12	38.02

Coasting vs. crossing in autumn at Rødbyhavn (Table 5.5, Appendix A.8, figures A.25):

12 out of 20 species display coasting behaviour in dependence of the wind. Of these 4 species are coasting mainly during head wind, but 6 during westerly cross winds. 9 out of 20 species are dependent on the wind situation when departing (Table 5.5, Appendix A.8, figures A.26). While 5 of these depart during easterly cross winds, 4 of them depart with tail winds.

Table 5.5 Summary of Kruskal-Wallis ANOVA by ranks – proportion coasting at Rødbyhavn during autumn 2010 for different wind components. Valid sample size (Valid N), p value of test (K-W test), Mean ranks of wind components and p values for significant results of multiple comparisons between wind components are given. For exact definitions of wind components see text.

Proportion Coasting for Autumn Season						
Species	Valid N	K-W test	Side E	Head	Side W	Tail
European Sparrowhawk	73	<0.01	25.31	50.90 (p 0.003-Side E, p 0.00002-Tail)	44.34 (p 0.006-Head)	20.53
Skylark	38	0.04	15.71	14.33	26.69	15.71
Meadow Pipit	54	0.01	20.96	25.59	34.86	20.83
Tree Pipit	36	0.01	10.75	21.11	29.10 (p 0.014-Side E)	15.44
Common Buzzard	35	0.02	13.10	27.17 (p 0.036-Tail)	21.35	13.43
Linnet	52	<0.01	19.80	33.19	33.71 (p 0.04-Head)	18.43
European Goldfinch	35	0.10	13.73	20.10	24.81	16.36
European Greenfinch	53	<0.01	16.83	34.92 (p 0.007-Side E)	36.30 (p 0.015-Head)	18.96
Eurasian Siskin	72	0.05	29.16	34.47	47.09	31.72
Jackdaw	47	0.15	19.56	25.75	28.93	19.83
Chaffinch	37	0.42	16.00	20.67	23.00	15.89
Common Crossbill	33	0.01	10.88	19.05	24.50 (p 0.029-Side E)	13.56
White Wagtail	47	<0.01	19.56	29.21 (p 0.047-Tail)	36.13 (p 0.004-Head)	15.88
European Starling	67	0.46	33.00	30.07	40.46	33.64

FEHMARNBELT BIRDS

Table 5.6 Summary of Kruskal-Wallis ANOVA by ranks – proportion departing at Rødbyhavn during autumn 2010 for different wind components. Valid sample size (Valid N), p value of test (K-W test), Mean ranks of wind components and p values for significant results of multiple comparisons between wind components are given. For exact definitions of wind components see text.

Proportion Departing for Autumn Season						
Species	Valid N	K-W test	Side E	Head	Side W	Tail
European Sparrowhawk	73	<0.01	48.31 (p 0.007-Head)	49.5 (p 0.0007-Head, p 0.09-Side W)	32.10	24.76
Skylark	38	0.2116	21.63	21.25	14.42	24.50
Meadow Pipit	54	0.0357	34.59	32.44	20.68	21.00
Tree Pipit	36	0.0131	25.75 (p 0.02-SideW)	22 (p 0.09-Side W)	7.90	15.89
Common Buzzard	35	0.0281	25.5 (p 0.06-Side W)	21.18	14.90	9.5
Linnet	52.00	0.0179	30.05	34.86 (p 0.06-Side W)	20.43	20.66
European Goldfinch	35	0.1040	21.64	20.23	11.0	16.3
European Greenfinch	53.00	<0.01	37.21 (p 0.007-Side W, p 0.02-Head)	35 (p 0.015-Side W, p 0.05-Head)	17.70	19.08
Eurasian Siskin	72.00	0.0724	44.34	40.41	27.15	32.97
Jackdaw	47.00	0.1438	33.00	23.17	20.07	22.67
Chaffinch	37	0.6500	22.63	19.78	16.19	17.88
Red Crossbill	33.00	0.0185	23.69 (p 0.03-Side W)	19.06	10.00	15.00
White Wagtail	47.00	0.0012	29.50 (p 0.004-Side W, p 0.04-Head)	31.91 (p 0.004-SideW, p 0.04-Head)	11.88	18.36
European Starling	67.00	0.2437	35.41	34.68		

As far as migration behaviour is concerned, in comparison with Puttgarden the results of the tests from Rødbyhavn were unambiguous, and followed the trends expected from the hypothesis. That is, a wide range of landbird species with large sample sizes tended to follow the coast of Lolland and avoided departing at Rødbyhavn during head winds and westerly cross winds, whereas they tended to depart at Rødbyhavn during tail winds and easterly cross winds.

As far as migration intensity is concerned very few landbird species showed a dependence on the wind situation at either land stations (5 out of 17 in spring at Puttgarden, and 2 out of 20 in autumn at Rødbyhavn).

These results suggest that both locations function as exit points for migrating landbirds in the region of the Fehmarnbelt. Yet the crossing behaviour of landbirds in relation to wind conditions only followed the expected favourable wind conditions at Rødbyhavn, whereas at Puttgarden most birds seemed to cross during unfavourable wind conditions (head winds). It is not known whether the tendency for migrating landbirds to cross at Puttgarden during head winds is mainly related to reverse low-altitude migration, while the major part of diurnal landbird migration pass at altitudes out of reach of the visual observations (Richardson 1978). This would be in line with most other results as well as general results from external data, which postulate that the crossing from Puttgarden to Rødbyhavn and back presents a main migration route in particular for daytime migrating species.

FEHMARNBELT BIRDS

With regard to coasting, the theory of Alerstam and Petterson (1977) suggests, that birds do coast as long as winds are unfavourable for crossing. This means, it is better / more economic for the birds to keep coasting, until either the crossing difference is smallest or the combination of wind drift, migrating speed and overall flight-time is most economic. Therefore, coasting birds would be expected under head-winds or onshore drift, which basically would mean winds between head-winds and both cross winds.

Generally speaking, for the coast of Fehmarn, facing NE, and the birds' main migration direction in spring is expected to be NE, easterly cross winds and head winds represent onshore drift, while westerly cross winds and tail-winds do not. The results support this only for westerly cross winds. In turn, at the coast of Lolland, facing SWS, with birds main migration direction in autumn being SW, those species coasting during head winds or westerly cross winds fully support the theory as formulated by Alerstam and Petterson (1977). Also, the 9 species departing during easterly cross winds or tail winds follow the expectation.

5.1.3 Distance to the coast in dependence of wind

Regarding the tests for wind-induced displacement of waterbirds towards the coast both the migration distance of the Common Eider and Common Scoter showed dependence of onshore wind conditions at Rødbyhavn and Puttgarden during spring and autumn migration. The shortest distances at the two coasts were recorded during S-cross and N-cross winds, respectively (Appendix A.8, Figures A.27, A.28, Table 5.7 – Table 5.8). However, only the tendency for shorter distances to the coast for Common Eider during spring was significant (Table 5.7).

Table 5.7 Summary of Kruskal-Wallis ANOVA by ranks – migration flight distance to Rødby during spring 2010 for different wind components. Valid sample size (Valid N), p value of test (K-W test), Mean ranks of wind components and p values for significant results of multiple comparisons between wind components are given. For exact definitions of wind components see text.

Migration flight distance for Spring Season at Rødby						
Species	Valid N	K-W test	N Cross	Head	S Cross	Tail
Melanitta nigra	85	0.047	59.00	34.56	35.50	48.12
Somateria mollissima	131	0.003	110.00 (p 0.001-S Cross)	73.95 (p 0.006-S Cross)	41.30 (p 0.03 S Cross)	67.2

Table 5.8 Summary of Kruskal-Wallis ANOVA by ranks – migration flight distance at Puttgarden during autumn 2010 for different wind components. Valid sample size (Valid N), p value of test (K-W test), Mean ranks of wind components and p values for significant results of multiple comparisons between wind components are given. For exact definitions of wind components see text.

Migration flight distance for Autumn Season						
Species	Valid N	K-W test	N Cross	S Cross	Tail	Head
Melanitta nigra	113	0.033	33.4	70.06	54.75	51.30
Somateria mollissima	119	0.037	29.8	72.67	58.31	56.08

5.2 *Bird migration and weather parameters - night-time acoustic observations*

One of the very few methods to identify bird species migrating at night is to listen to their calls. Catching birds at night (tape-luring, light traps) or analysing the victims of nocturnal collisions with ground objects also provide information on the species-specific level, but these methods are difficult to apply systematically, and they interfere with the natural process of migration (Mukhin et al 2008, Drewitt & Langston 2008). The other methods such as radars, infrared camera, moon-watching are able to classify objects into few size categories or ecological groups (waders, ducks, passerines, sometimes swifts), but most of the objects remain unidentified. In this situation only systematic long-term acoustic projects recording night calls can provide the information about seasonal dynamics of nocturnal migration of individual species and influence of different factors on it.

Night calls do not only reflect the number of birds passing an area. The number of calls recorded will depend on the number of birds on passage, their flight altitude but also their vocalisation activity. As in visual surveys, the number of recorded birds likely depends on their flight height as birds may not be heard in the same proportion if flight height increases. This might be the case in response to weather conditions. Relating the intensity of night calls to weather conditions may thus provide some insight under which weather conditions nocturnal migrants occur and which species might fly at low altitudes in response to adverse weather conditions. This is of special interest for the EIA of a fixed link. Five acoustic recording stations were in operation in the area of Fehmarnbelt with one onshore and one inland station at both Lolland and Fehmarn, and one offshore station based on a ship anchored in the middle of Fehmarnbelt (Figure 3.1). Obviously, data from the offshore ship were only available whenever it was on effort.

The basic parameter obtained during from acoustic observations was the number of calls per hour emitted by several nocturnally migrating species. The influence of different factors on number of recorded calls is reviewed by Farnsworth (2005). Primarily, this parameter depends on the distance between the calling bird and the microphone (which is the mixture of flight altitude and horizontal distance to the microphone). The further away a bird is from the microphone – the less is the probability it will be recorded. Also the biological factors are important – species-specific intensity of nocturnal signalisation and structure of the calls, the presence of birds in the air, the seasonal difference of intensity of calling.

Here the relationships between the intensity of calling and the geographic location in the Fehmarnbelt area (at the coast, over water, or inland) and weather conditions (cloud altitude, cloud cover, visibility, wind speed) are presented.

Five acoustic recording stations were in operation in the area of Fehmarnbelt with one onshore and one inland station at both Lolland and Fehmarn, and one offshore station based on a ship anchored in the middle of Fehmarnbelt (Figure 3.1). During most nights the acoustic recordings at these stations were undertaken synchronously. Obviously, data from the offshore ship were only available whenever it was on effort.

The comparison of dynamics of nocturnal calling reveals different strategies of usage of nocturnal calls by different species. The intensity of calling depends on the geographic location in the Fehmarnbelt area (at the coast, over water, or inland) and weather conditions (cloud altitude, cloud cover, visibility, wind speed).

For ease of presentation, in the following figures the negative scale has also been used to view call intensity of onshore and inland locations at the same figure.

FEHMARNBELT BIRDS

5.2.1 Barnacle Goose

Comparable intensities of night calling at inland and onshore stations were recorded for Barnacle Geese with the exception of Fehmarn inland station where the number of nocturnal calls was much higher than onshore and at Lolland (Figure 5.1). Very few calls were detected offshore. It must be noted, that large migrating Barnacle Geese flocks are also observed during daytime, however mainly only at the Lolland coast. The highest numbers of calls were recorded during nights with high cloud cover and migration also occurred at nights with low visibility, the only parameters affecting calling intensities (Figure 5.2). It can be concluded that during overcast nights Barnacle Geese fly at lower altitudes and may thus be exposed to the risk of collision with the ground structures.

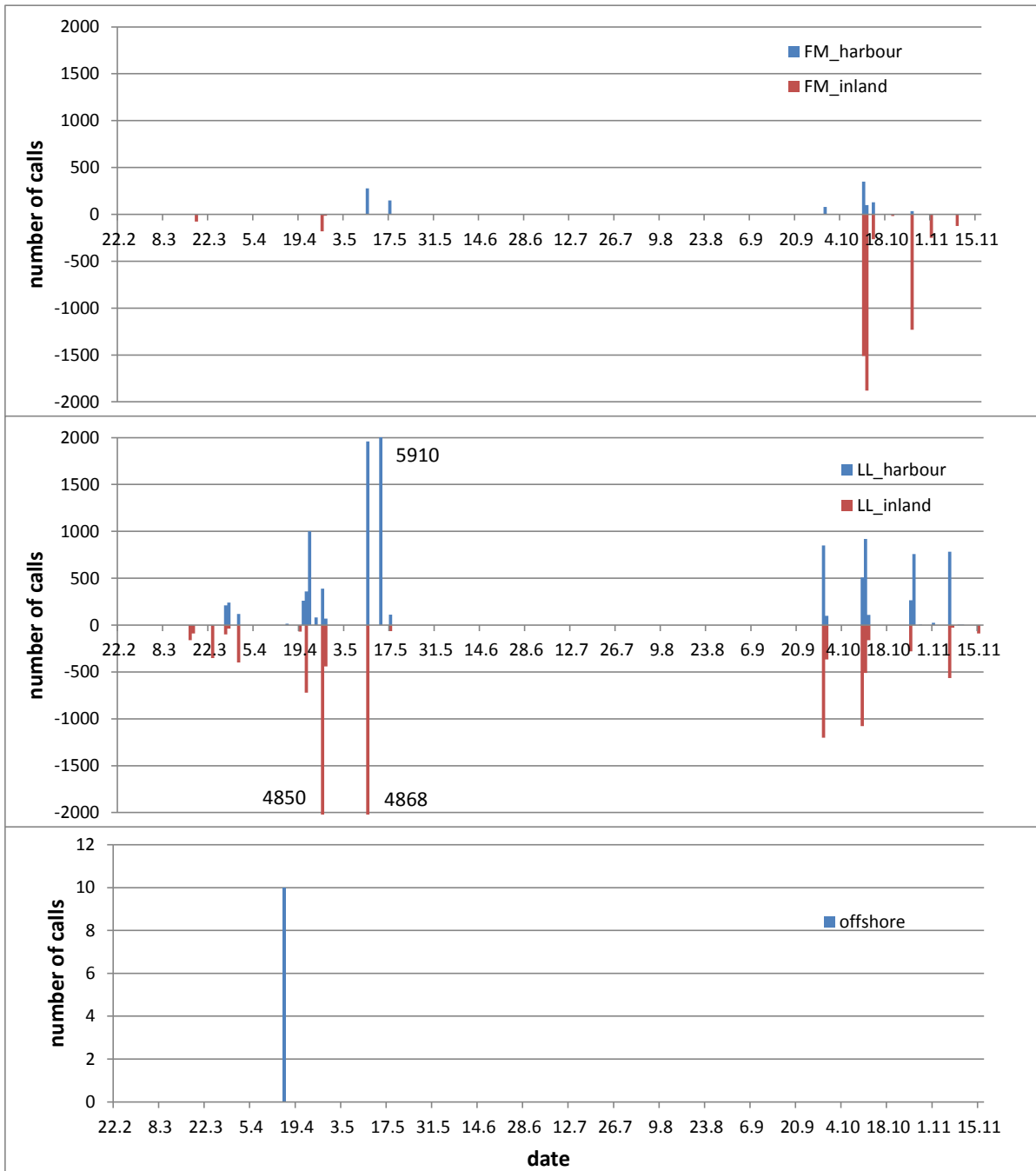

Figure 5.1 Number of nocturnal calls of Barnacle Goose at Lolland onshore (LL_harbour), Lolland inland (LL_inland), Fehmarn onshore (FM_harbour), Fehmarn inland (FM_inland) and on the ship (offshore) in 2010.

FEHMARNBELT BIRDS

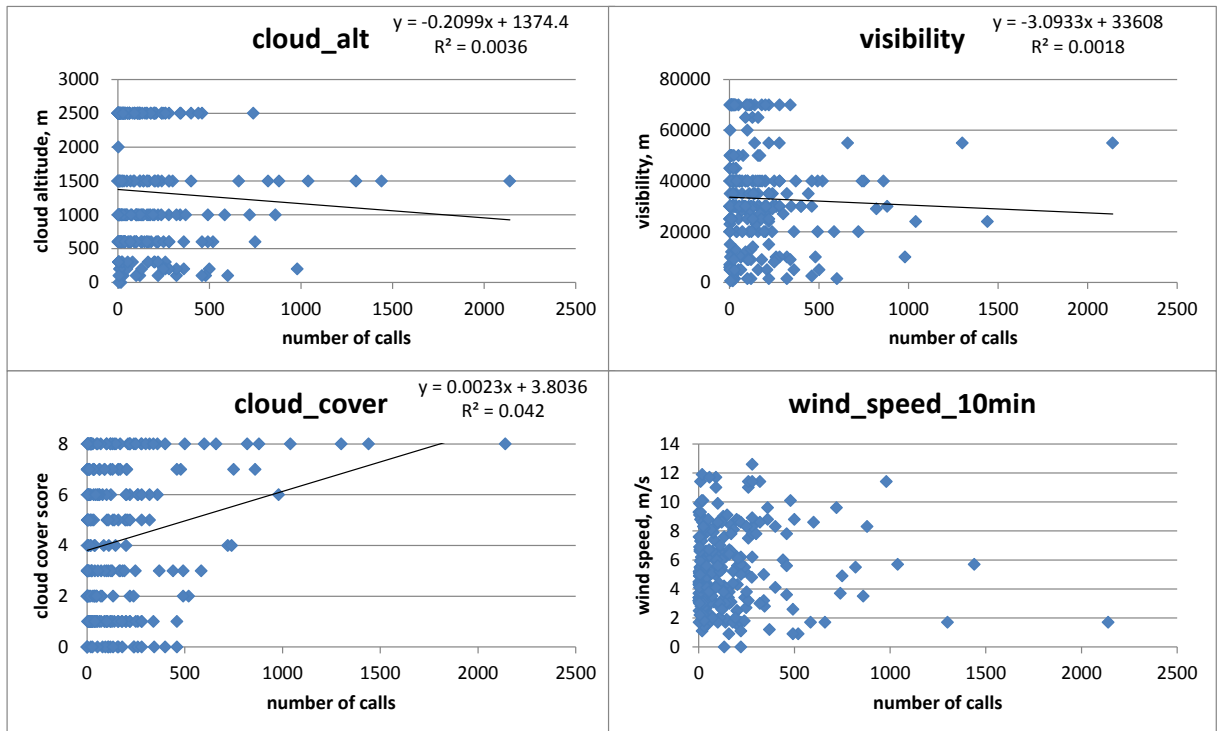

Figure 5.2 Weather conditions and the number of nocturnal calls per hour in 2009 and 2010 at all stations for Barnacle Goose.

5.2.2 Wigeon

For Wigeons no spatial pattern of calling intensity was detected. More calls were recorded in spring as compared to autumn (Figure 5.3). Almost no Wigeons were recorded on the offshore station. No clear increase of calling intensity under specific weather conditions was observed (Figure 5.4). As in Barnacle Geese, Wigeon migration was recorded under low visibility and high cloud cover.

FEHMARNBELT BIRDS

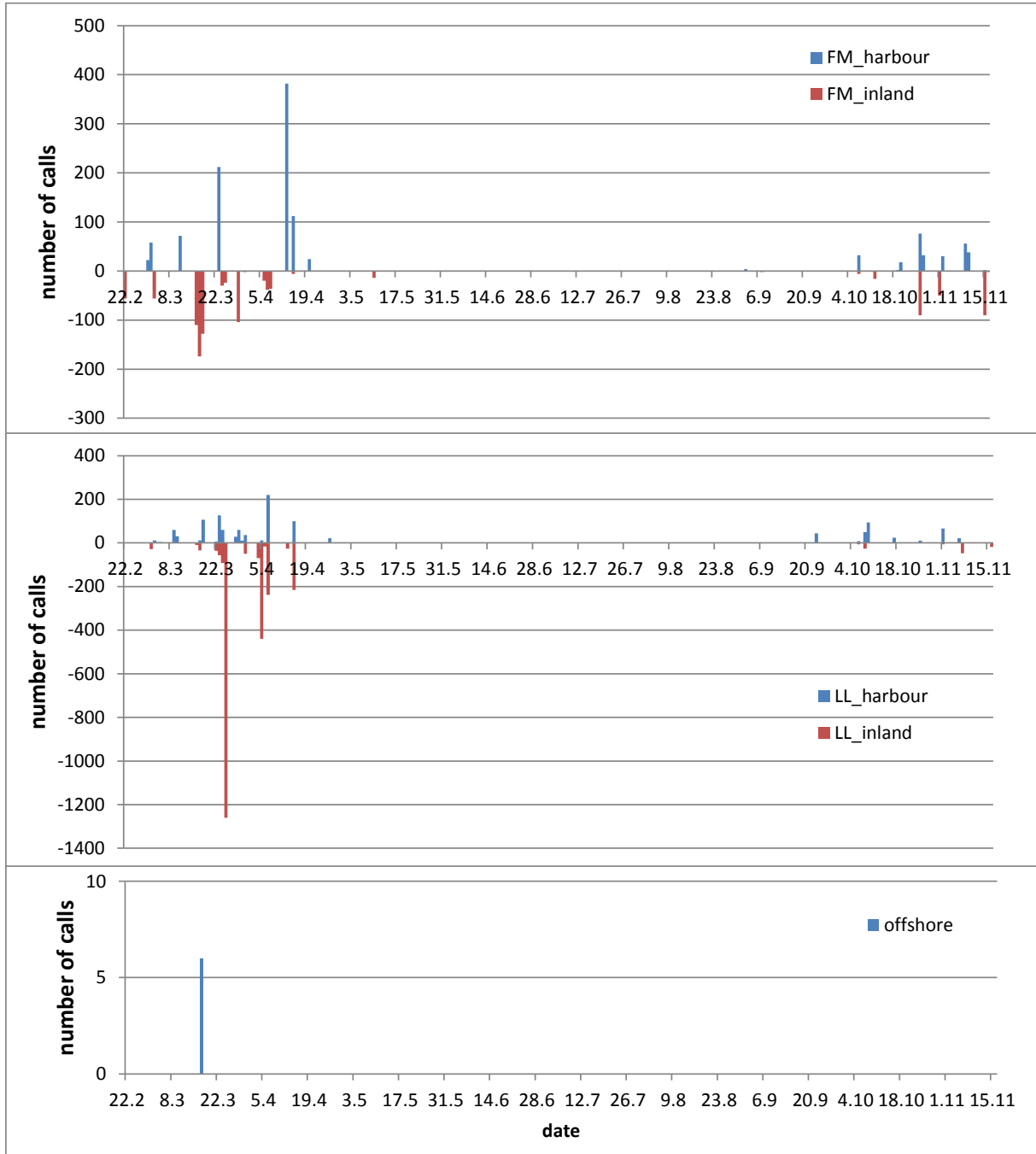

Figure 5.3 Number of nocturnal calls of Wigeon at Lolland onshore (LL_harbour), Lolland inland (LL_inland), Fehmarn onshore (FM_harbour), Fehmarn inland (FM_inland) and on the ship (offshore) in 2010.

FEHMARNBELT BIRDS

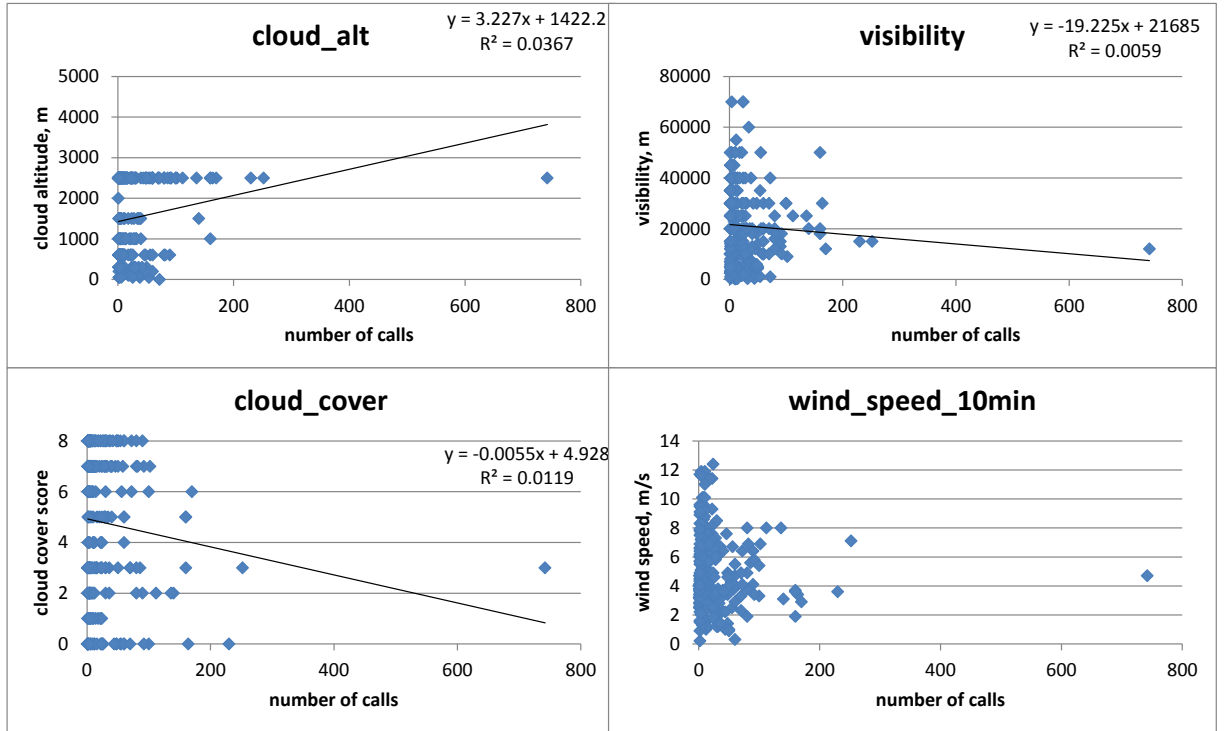

Figure 5.4 Weather conditions and the number of nocturnal calls per hour in 2009 and 2010 at all stations for Wigeon.

5.2.3 Eurasian Curlew

As for Wigeon, the number of night calls of Curlews did not reveal a spatial pattern, but was higher during the short spring migration in comparison to the other part of the year (Figure 5.5). Adverse weather conditions were not found to result in more calls of Curlews, nor did low visibility. In contrast, maximal numbers of calls were recorded with high cloud altitude and low cloud cover score and the data indicate a clear preference for good weather conditions (Figure 5.6). Therefore, the number of calls may correctly reflect migration intensity.

FEHMARNBELT BIRDS

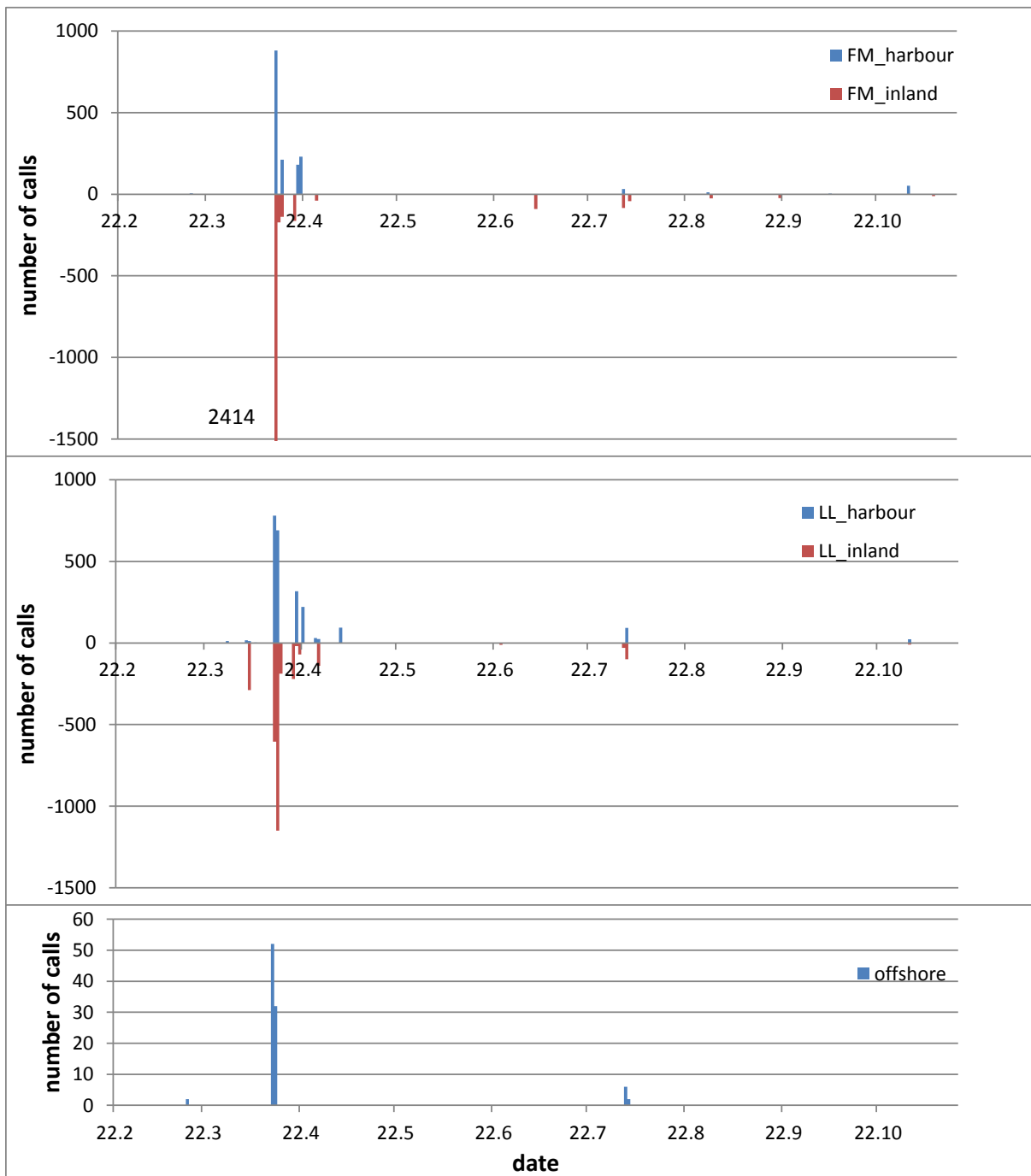

Figure 5.5 Number of nocturnal calls of Eurasian Curlews at Lolland onshore (LL_harbour), Lolland inland (LL_inland), Fehmarn onshore (FM_harbour), Fehmarn inland (FM_inland) and on the ship (offshore) in 2010.

FEHMARNBELT BIRDS

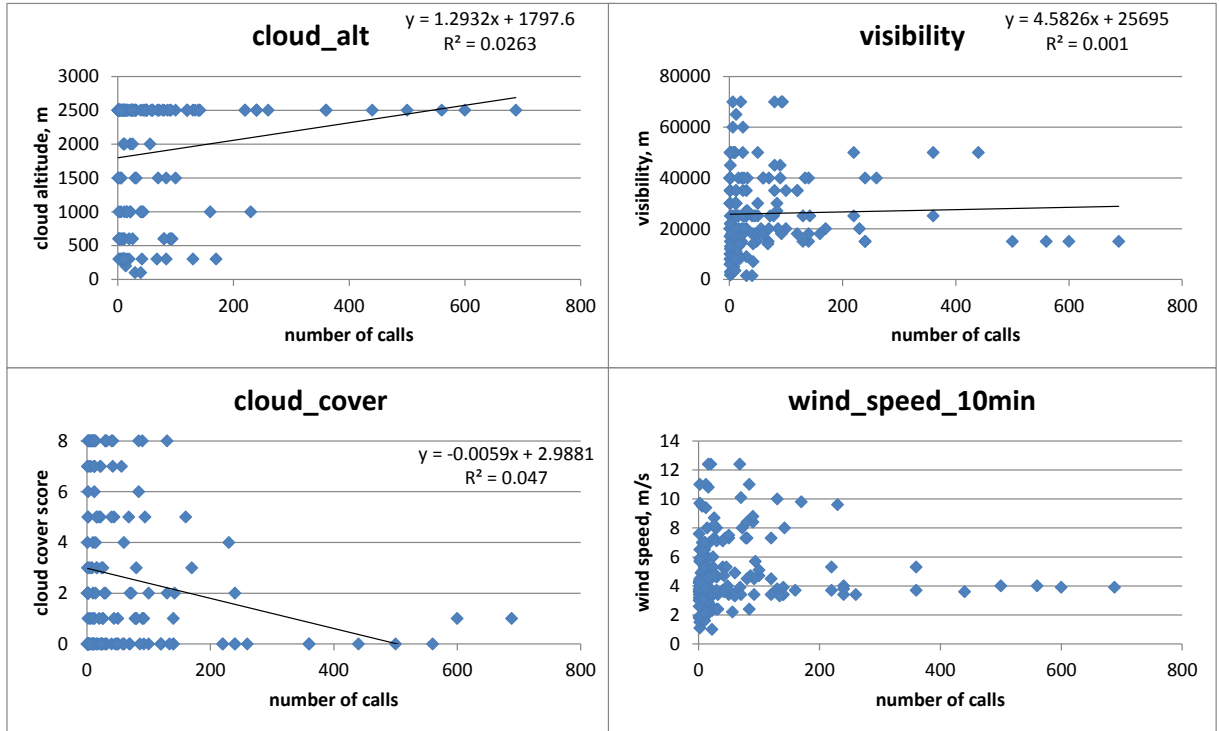

Figure 5.6 Weather conditions and the number of nocturnal calls per hour in 2009 and 2010 at all stations for Eurasian Curlew.

5.2.4 Skylark

The number of nocturnal calls of Skylarks did not depend on the geographic features of Fehmarnbelt area (Figure 5.7). The maximal number of calls of this species was recorded in a situation of low visibility and low cloud altitude (Figure 5.8). These weather conditions may stimulate Skylarks to fly lower, possibly reaching the height of the ground structures.

FEHMARNBELT BIRDS

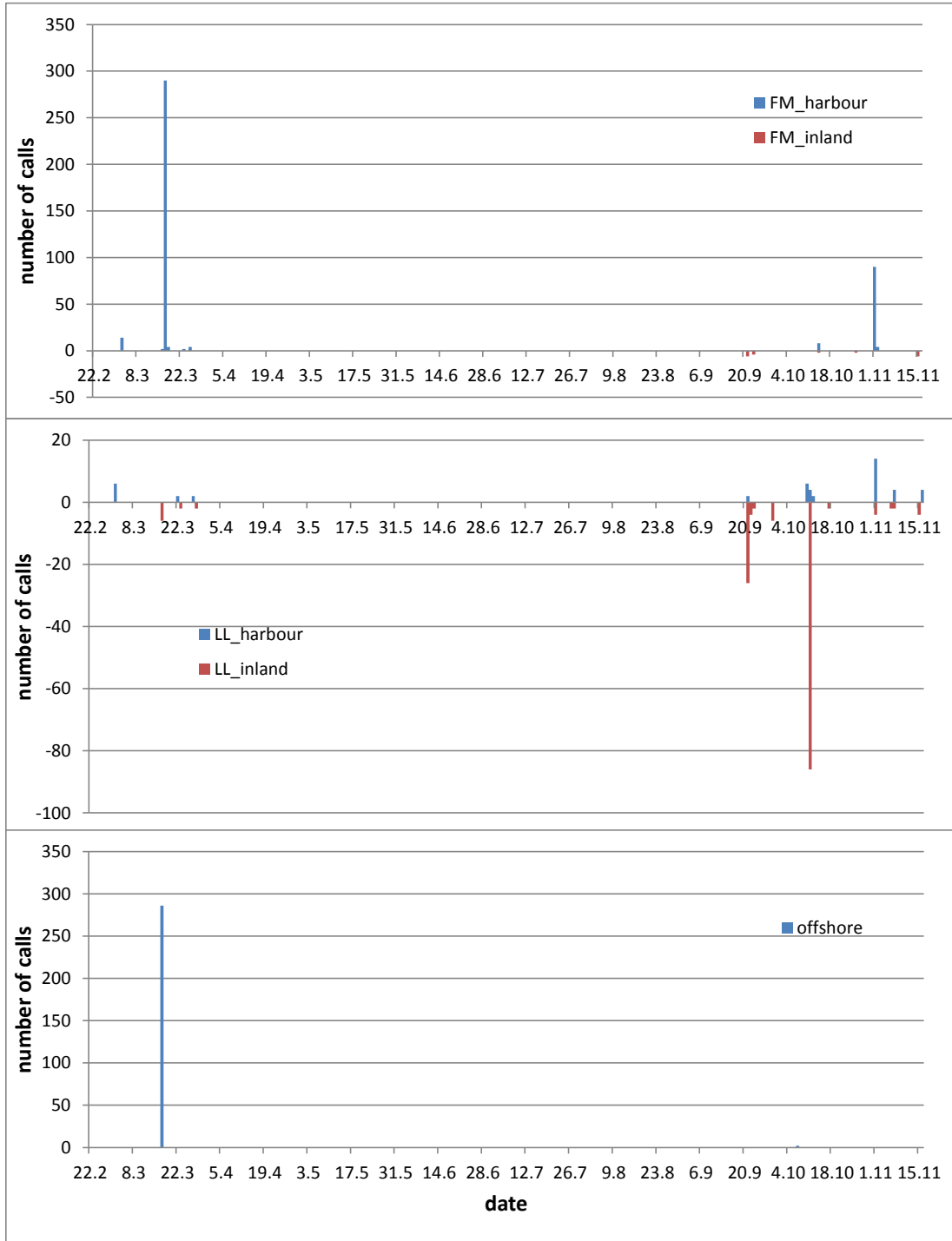

Figure 5.7 Number of nocturnal calls of Skylark at Lolland onshore (LL_harbour), Lolland inland (LL_inland), Fehmarn onshore (FM_harbour), Fehmarn inland (FM_inland) and on the ship (offshore) in 2010.

FEHMARNBELT BIRDS

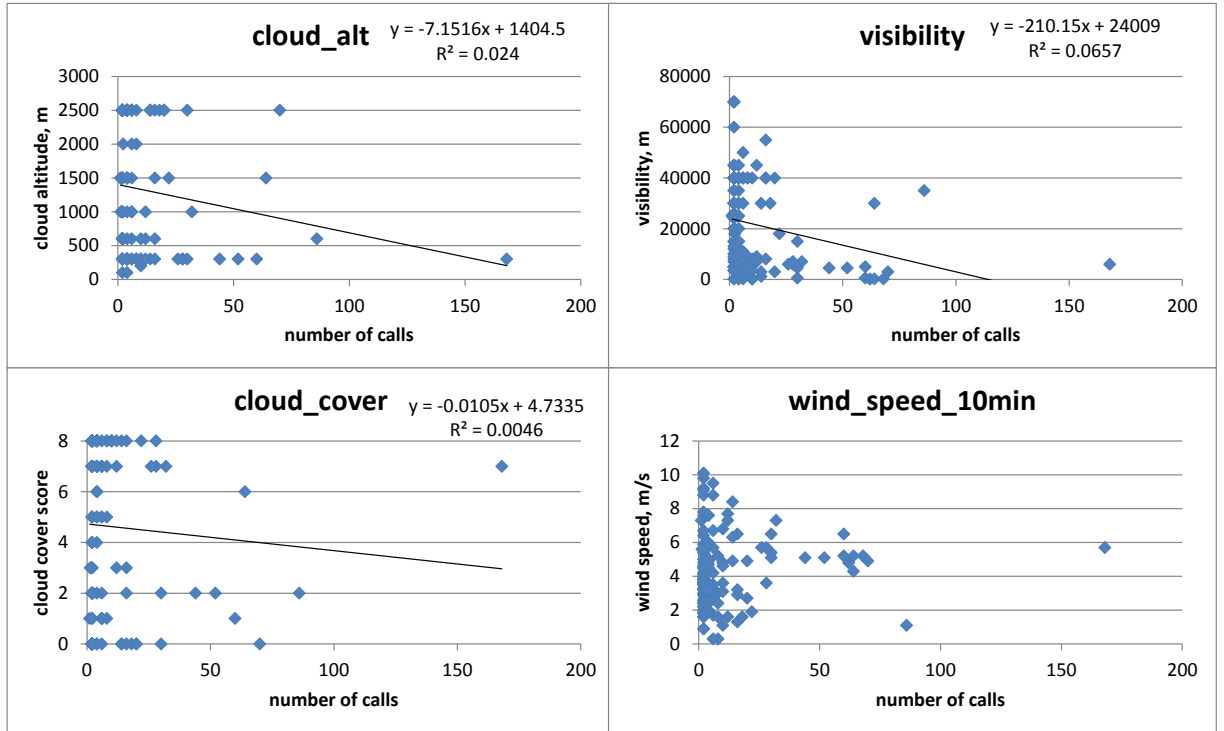

Figure 5.8 Weather conditions and the number of nocturnal calls per hour in 2009 and 2010 at all stations for Skylark.

5.2.5 Tree Pipit

The number of recorded calls of Tree Pipits is higher at the coastal stations (Fehmarn in spring and Lolland in autumn) (Figure 5.9, Figure 5.10). The number of calls at inland stations remains approximately the same for all seasons and locations. The reasons for this spatial pattern remain unclear. Maximal number of calls was recorded during overcast nights (Figure 5.11). Other weather parameters do not seem to play an important role. The increasing number of calls recorded during high cloud cover may indicate that Tree Pipits fly at lower altitudes under these conditions.

FEHMARNBELT BIRDS

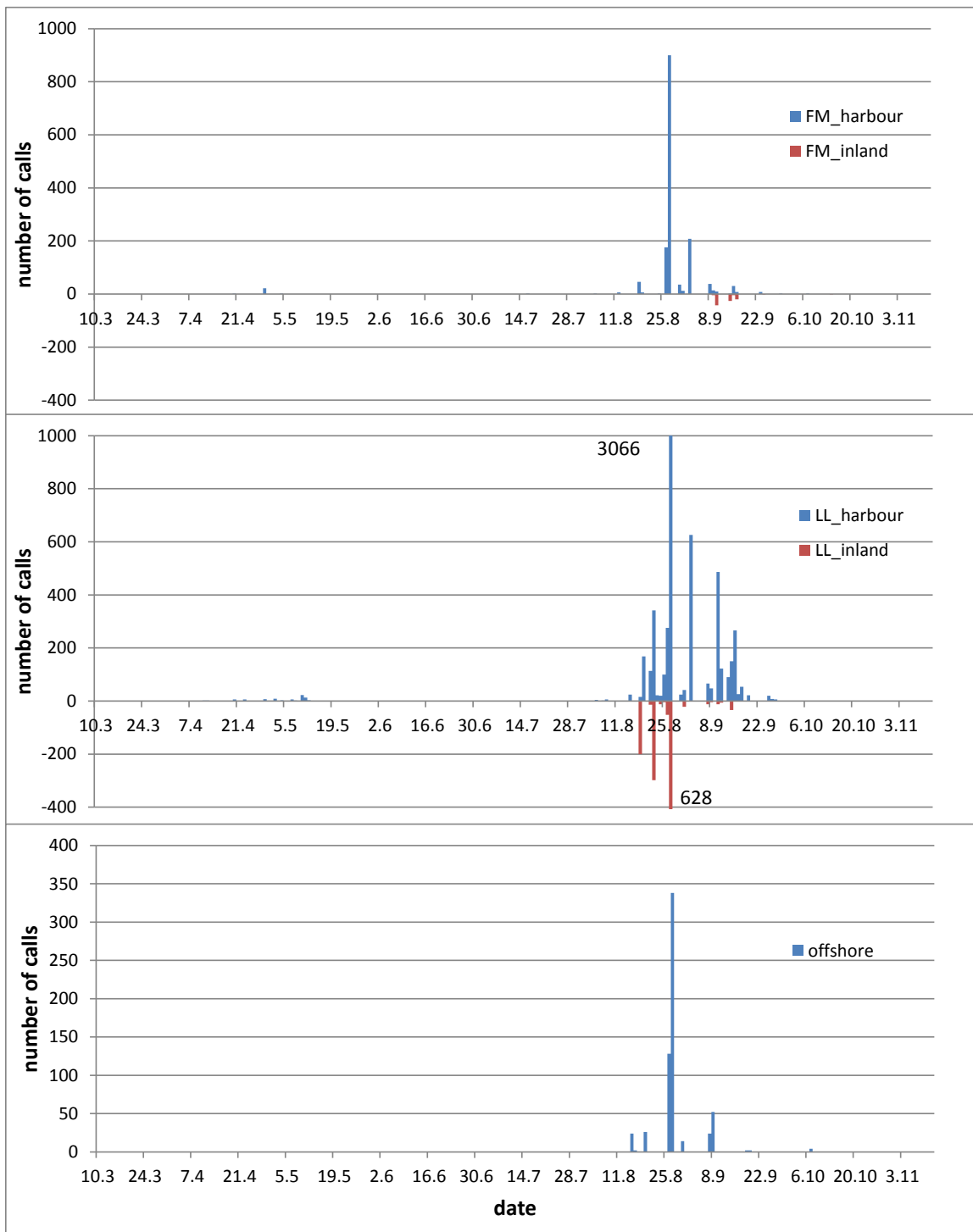

Figure 5.9 Number of nocturnal calls of Tree Pipit at Lolland onshore (LL_harbour), Lolland inland (LL_inland), Fehmarn onshore (FM_harbour), Fehmarn inland (FM_inland) and on the ship (offshore) in 2009.

FEHMARNBELT BIRDS

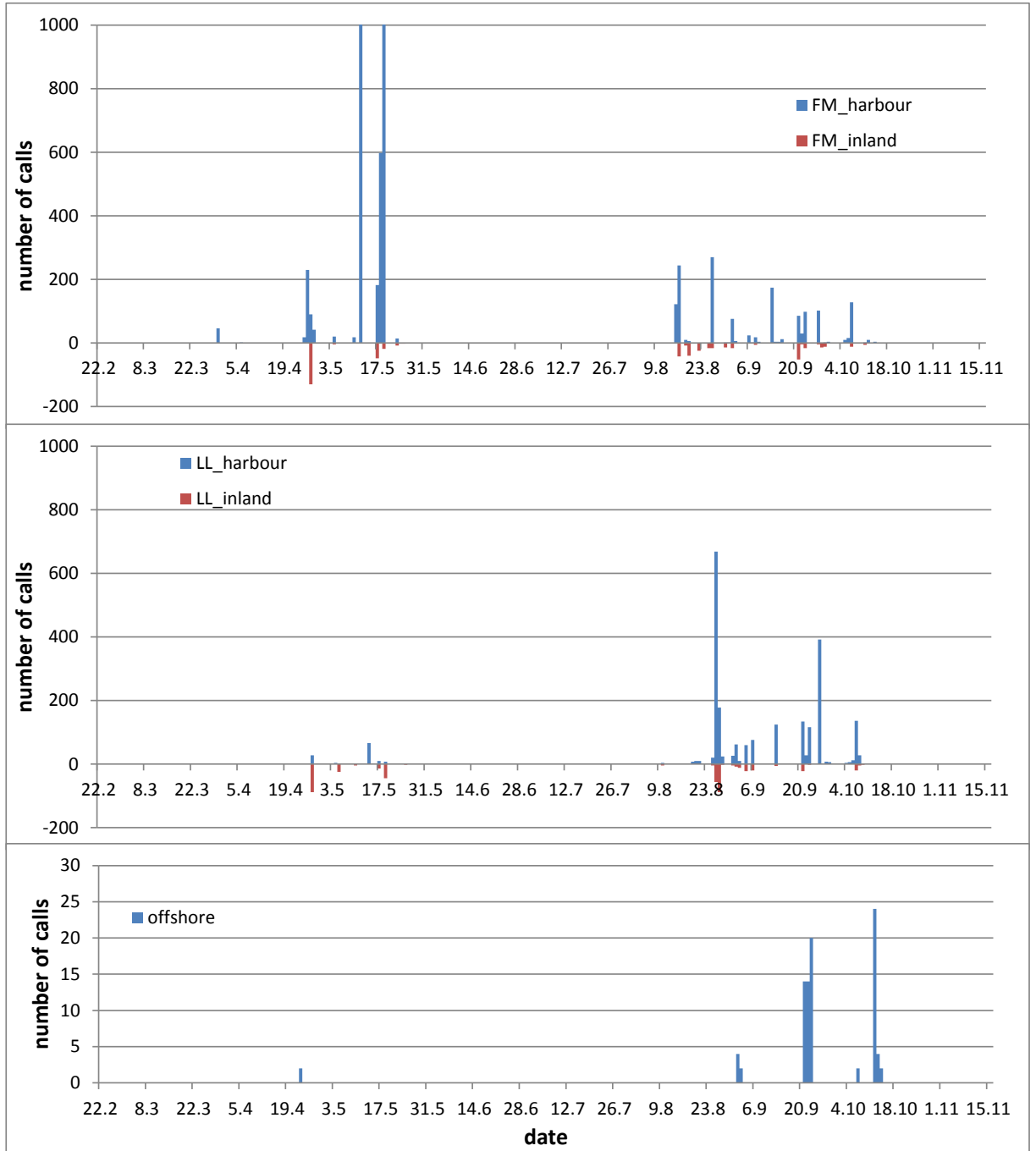

Figure 5.10 Number of nocturnal calls of Tree Pipit at Lolland onshore (LL_harbour), Lolland inland (LL_inland), Fehmarn onshore (FM_harbour), Fehmarn inland (FM_inland) and on the ship (offshore) in 2010.

FEHMARNBELT BIRDS

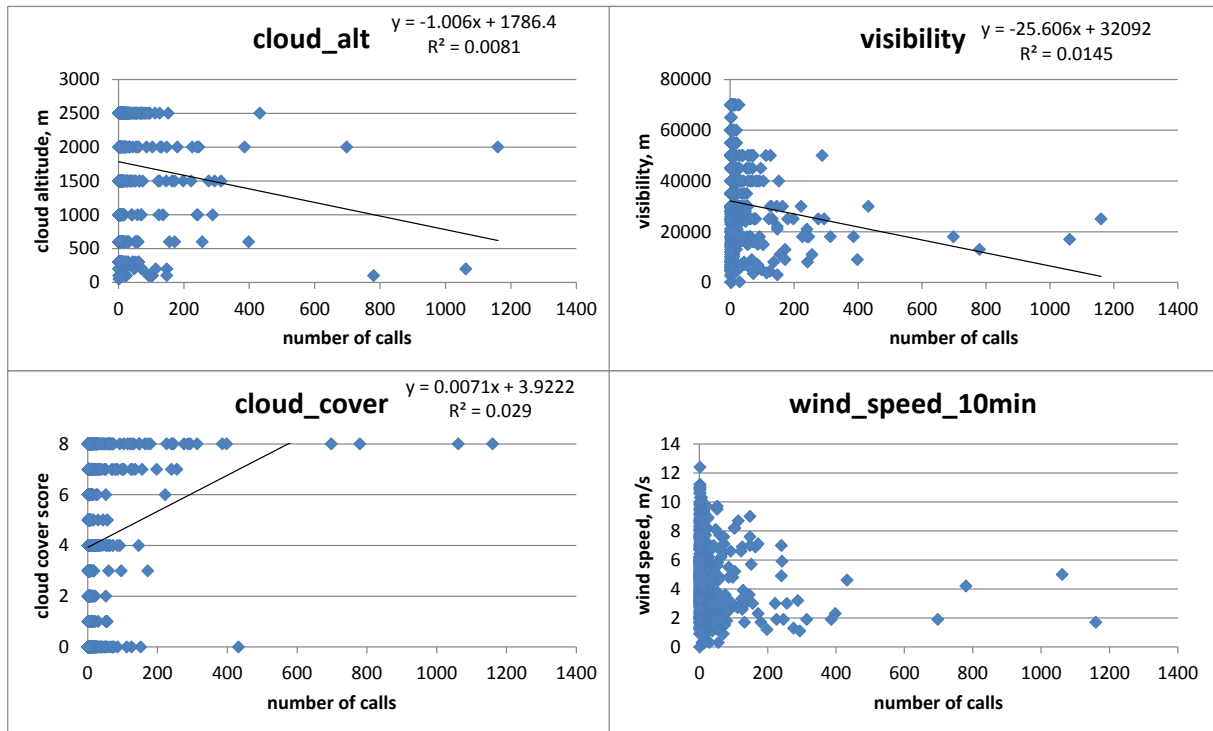

Figure 5.11 Weather conditions and the number of nocturnal calls per hour in 2009 and 2010 at all stations for Tree Pipit.

5.2.6 Robin

Robin is one of the most numerous nocturnal migrants in Europe. The number of calls recorded of this species was considerably lower during spring compared to autumn at all locations. Also the number of recorded calls was much higher at the coasts and offshore than inland (Figure 5.12, Figure 5.13). The figures of the relation between number of calls and weather parameters show that nocturnal calling of this species is not related to adverse weather conditions such as low visibility, low cloud altitude or cloud cover (Figure 5.14). Therefore, the number of calls may reflect the number of birds aloft, at least in autumn.

The accumulation of juvenile land birds (Robins and thrushes in particular) during their first autumn migration at the coast lines is a well known phenomenon (Payevsky 1998). The baseline nocturnal recordings may shed some light on the mechanism of this accumulation of young Robins at the coasts. The numbers of calls increased at the coast lines in autumn, and potential reasons for that could be the increasing inclination for emitting calls, or birds descending at the coastlines. It means Robins observe the terrain they cross and react on it. Decisions to land may depend on the amount of fat reserves accumulated by a bird. Investigations have shown, that a large proportion of young birds trapped at coast lines are lean (Karlsson et al 1988). Experiments also show that lean Robins even choose the opposite flight direction in comparison to their normal autumn routes (Sandberg 1994).

Probably, the concentration of juvenile Robins at the coastlines and increase of number of the calls are related processes. The high number of calls of Robins could be an indication of presence of large numbers of birds at low altitudes within the range of ground structures.

FEHMARNBELT BIRDS

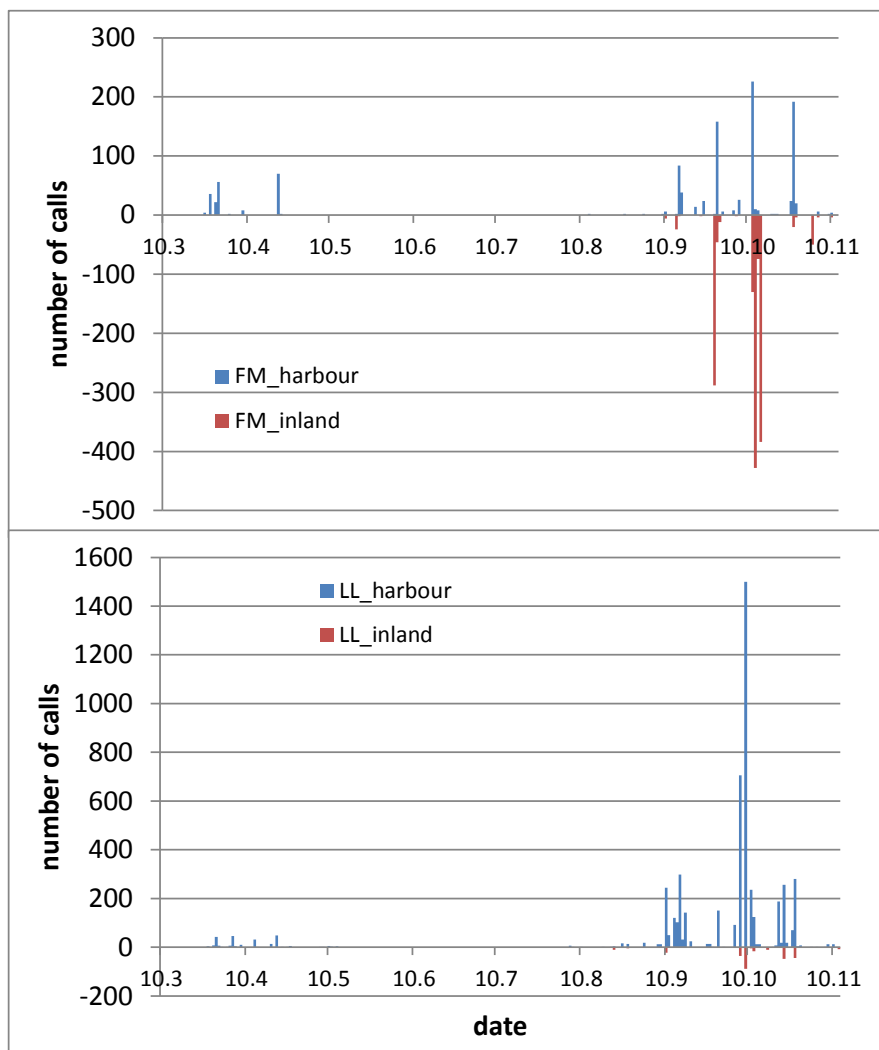

Figure 5.12 Number of nocturnal calls of Robin at Lolland onshore (LL_harbour), Lolland inland (LL_inland), Fehmarn onshore (FM_harbour), Fehmarn inland (FM_inland) and on the ship (offshore) in 2009.

FEHMARNBELT BIRDS

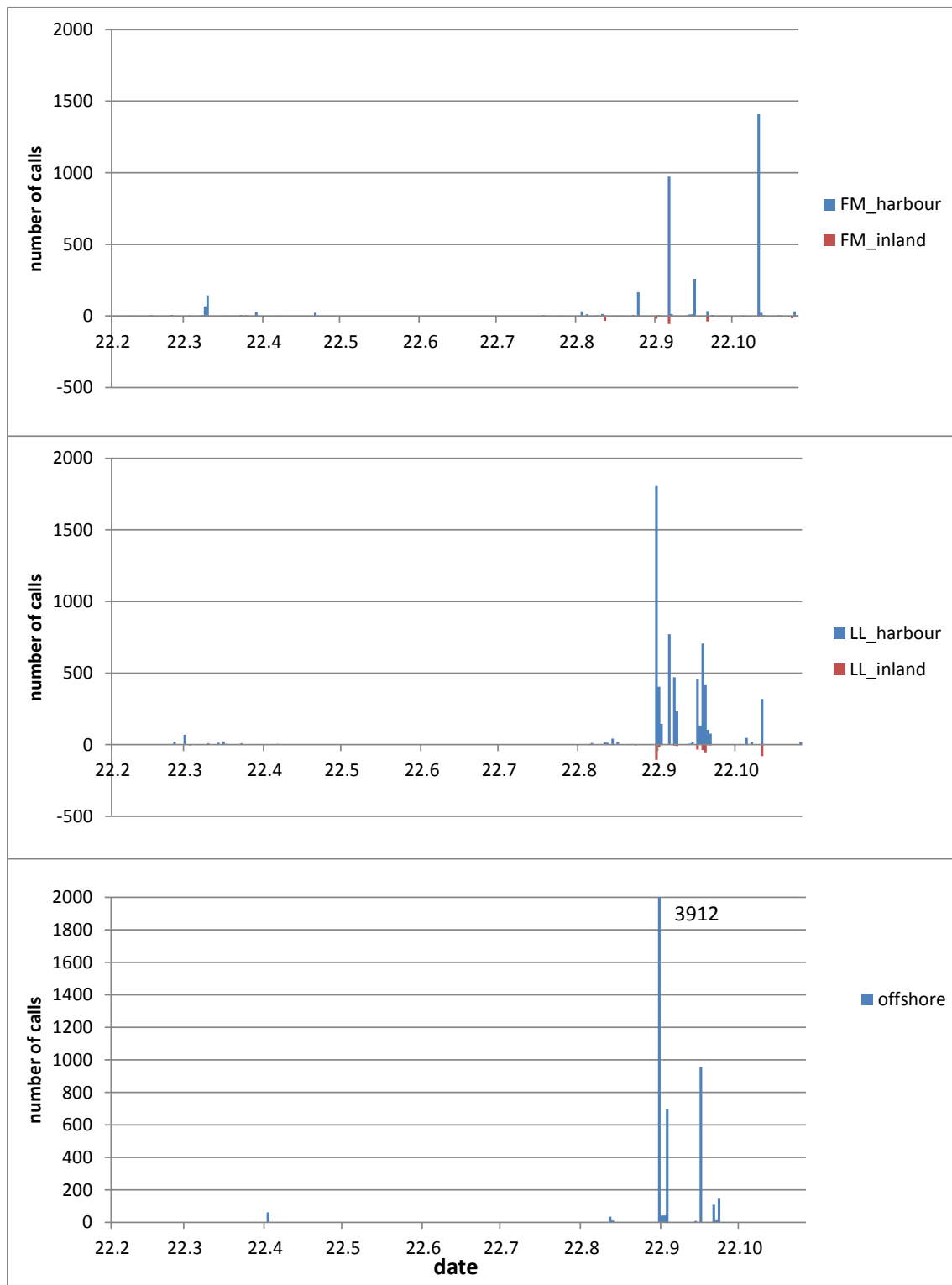

Figure 5.13 Number of nocturnal calls of Robins at Lolland onshore (LL_harbour), Lolland inland (LL_inland), Fehmarn onshore (FM_harbour), Fehmarn inland (FM_inland) and on the ship (offshore) in 2010.

FEHMARNBELT BIRDS

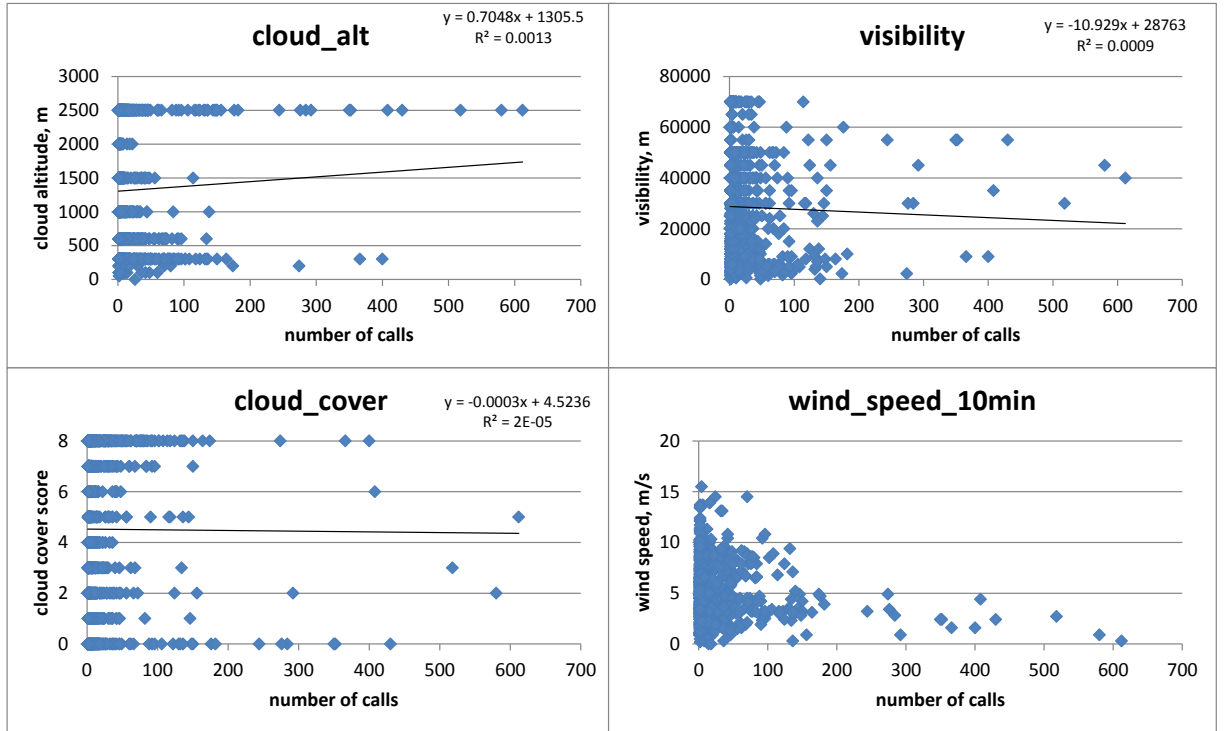

Figure 5.14 Weather conditions and the number of nocturnal calls per hour in 2009 and 2010 at all stations for Robin.

5.2.7 Blackbird

A very high number of calls recorded calls belonged to Blackbird. Very few calls were recorded inland, but every season high numbers of Blackbird calls were recorded at the coastal stations and at times also on the offshore station (Figure 5.15). Unlike many other species, relatively high numbers of Blackbird calls were also found at the coastal stations in spring. Blackbird calls were recorded in higher numbers on overcast nights with low visibility (Figure 5.16).

FEHMARNBELT BIRDS

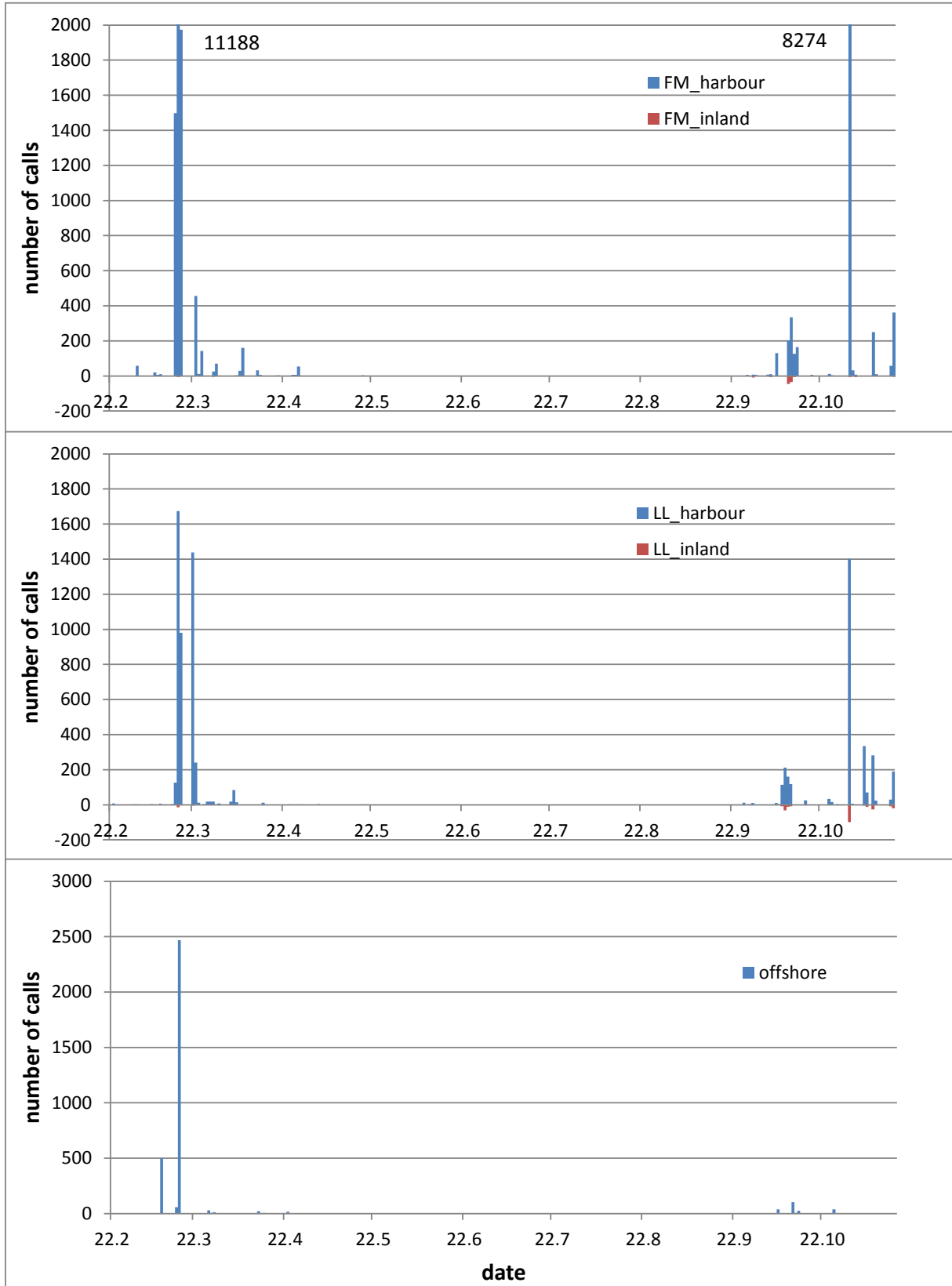

Figure 5.15 Number of nocturnal calls of Blackbird at Lolland onshore (LL_harbour), Lolland inland (LL_inland), Fehmarn onshore (FM_harbour), Fehmarn inland (FM_inland) and on the ship (offshore) in 2010.

FEHMARNBELT BIRDS

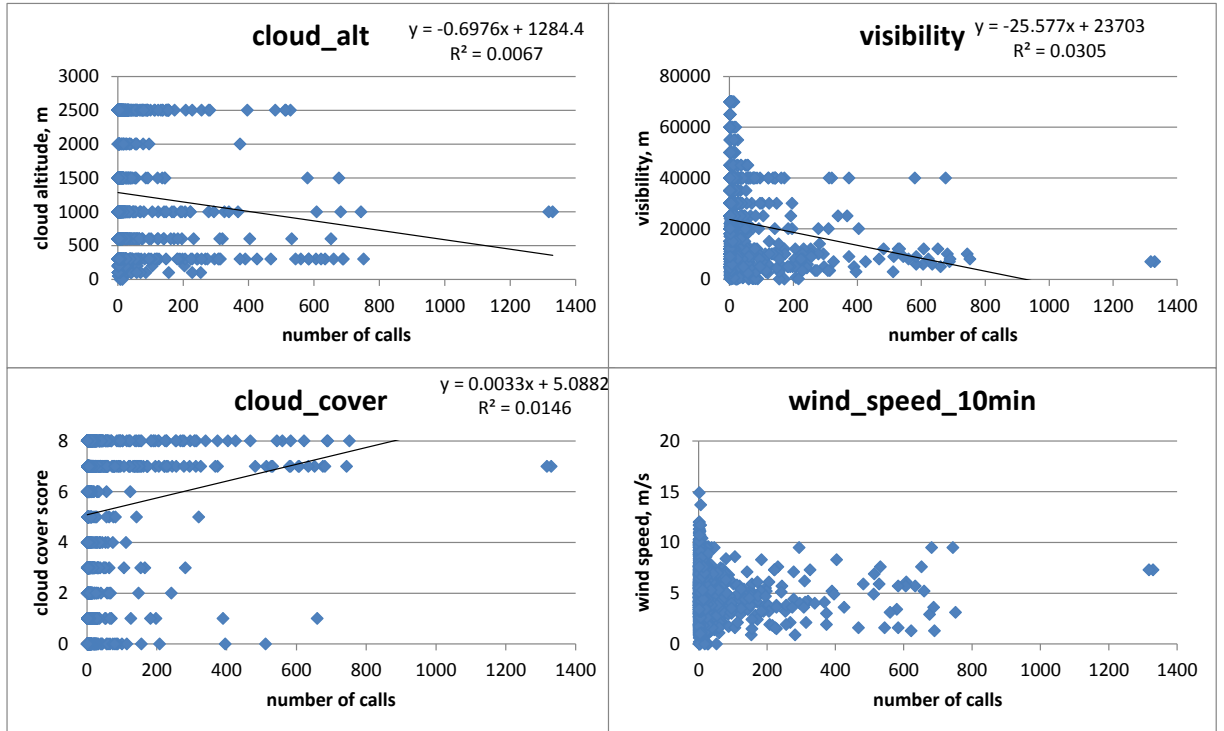

Figure 5.16 Weather conditions and the number of nocturnal calls per hour in 2009 and 2010 at all stations for Blackbird.

5.2.8 Song Thrush

Song Thrush is the species, which has been recorded with the highest number of calls. As for Robins the number of calls is much higher during autumn migration, and the vast majority of the calls were recorded at the coast lines at both sides of Fehmarnbelt (Figure 5.17, Figure 5.18). As with Robin, it is likely that mainly juvenile birds emit these calls when approaching the coast line.

The maximal numbers of calls of Song Thrushes was recorded during adverse weather conditions with low cloud altitude, overcast and low visibility and high wind speed (about 8 m/s) (Figure 5.19).

FEHMARNBELT BIRDS

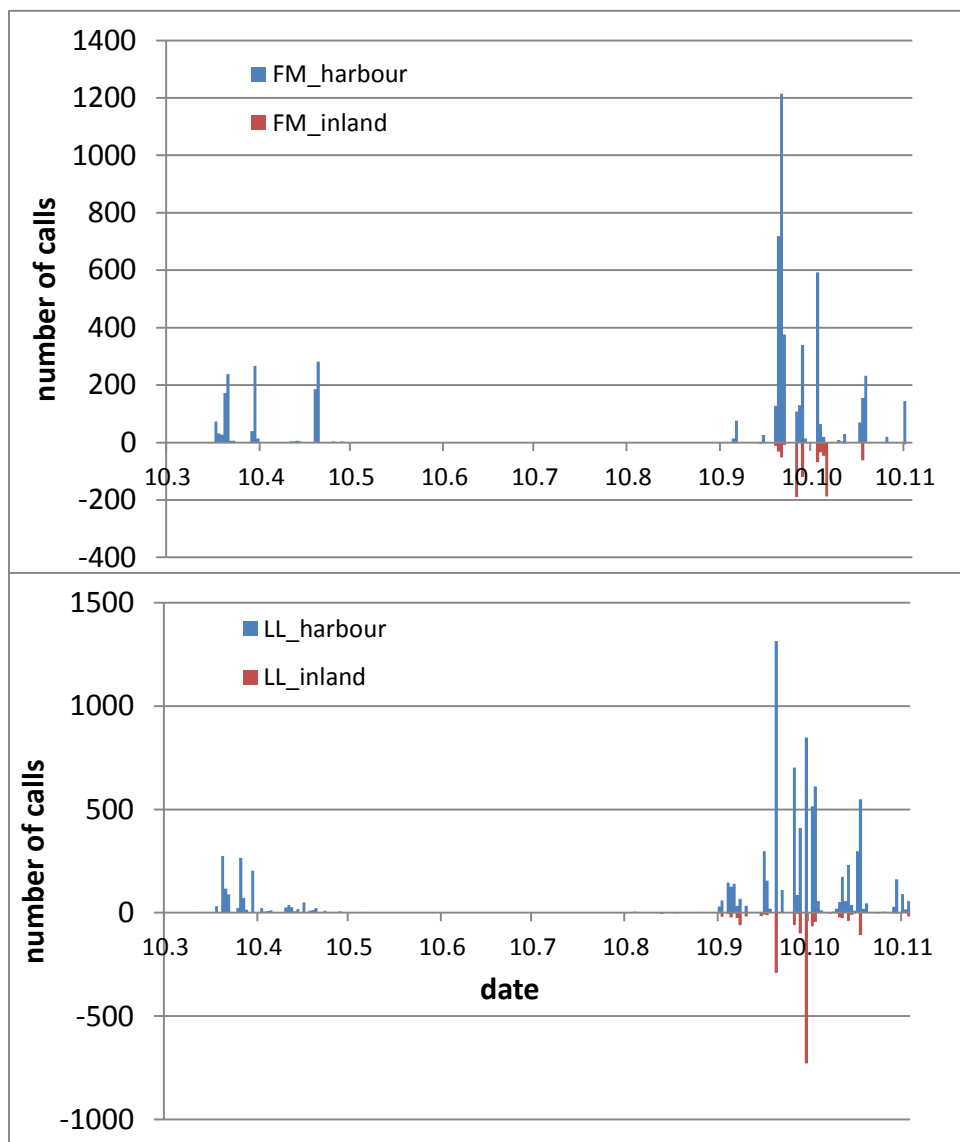

Figure 5.17 Number of nocturnal calls of Songthrush at Lolland onshore (LL_harbour), Lolland inland (LL_inland), Fehmarn onshore (FM_harbour), Fehmarn inland (FM_inland) and on the ship (offshore) in 2009.

FEHMARNBELT BIRDS

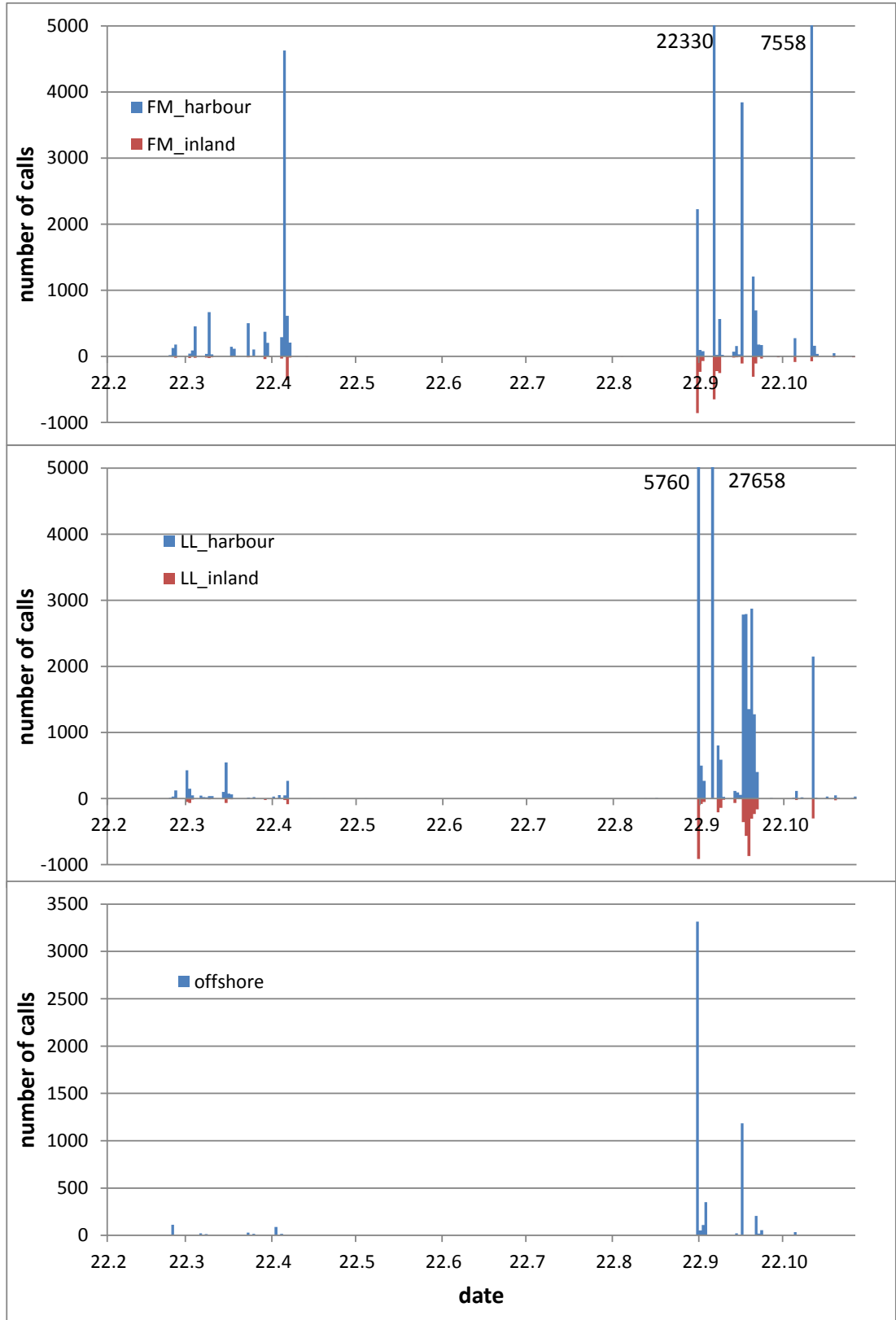

Figure 5.18 Number of nocturnal calls of Songthrush at Lolland onshore (LL_harbour), Lolland inland (LL_inland), Fehmarn onshore (FM_harbour), Fehmarn inland (FM_inland) and on the ship (offshore) in 2010.

FEHMARNBELT BIRDS

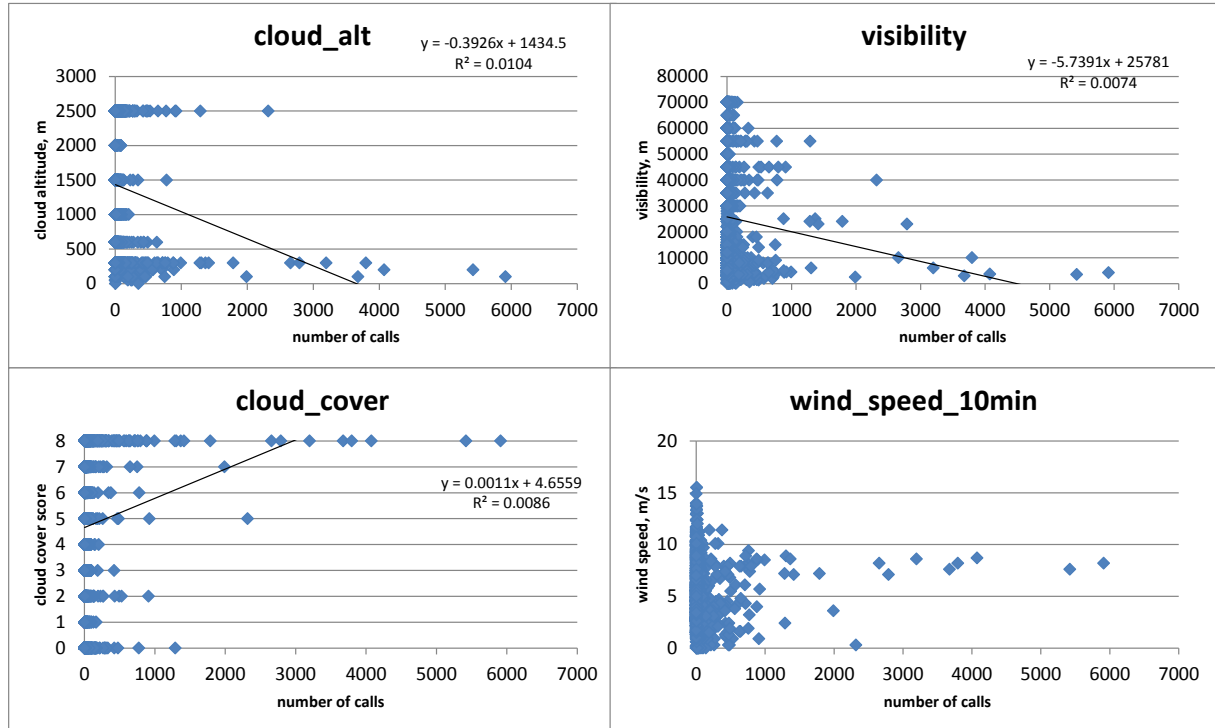

Figure 5.19 Weather conditions and the number of nocturnal calls per hour in 2009 and 2010 at all stations for Songthrush.

5.2.9 Summary

For the eight species considered and most likely more, acoustic recordings provide a measure of calling and thus migration intensity. However, as only birds in the vicinity of the microphones can be detected, high calling intensity will always be related to low migration altitude.

The seasonal dynamics of recordings have a species-specific pattern in time and space. Several species were frequently recorded at the coastline or offshore, but not inland (Song Thrush, Blackbird, Robin, Tree Pipit), while some species call with similar intensity at both the coasts and inland (Skylark, Curlew, Wigeon, Barnacle Goose). Calls of Song Thrush, Robin and Tree Pipit were recorded more often in autumn. Blackbird, Skylark, Curlew, Wigeon and Barnacle Goose were frequently recorded also in spring. Irrespective of the reasons of this pattern, it indicates different behaviour of species at different locations of Fehmarnbelt area, with even closely related species exhibiting different strategies of migration across the Fehmarnbelt.

Regional details of species-specific nocturnal migration have so far remained largely unknown. Here, the baseline investigations on night-time acoustics already provide unique results. As described before, limitations apply to these data, as results are only available for species calling at night and for species "heard" since they are close enough to the recording place. However, for selected species results provide valuable insight into their migration behaviour also in dependence on weather factors.

Different species-specific factors may influence the number of calls emitted by birds such as weather conditions, season, topography, but the fundamental problem of unknown flight altitude of calling birds leads to uncertainty of interpretations of results. From the general perspective, the large numbers of calls recorded by

stations on the ground could be a proxy for the presence of birds at the low altitudes and risks related to that.

Of the passerines, only Robin seems to be unaffected by weather. Calling intensity may depend on juvenile birds descending to the ground, i.e. landing at coastal locations for foraging in order to gain additional weight. The other passerines are affected by the weather, thus, calling intensity will also be a hint to low migration altitudes during certain weather situations. Thus, species may initiate migration during favourable weather conditions, but may come into trouble once those favourable weather conditions turn bad.

For Barnacle Goose, Wigeon and Curlew weather does not seem to play a role with regard to calling intensity, thus, calling intensity might reflect migration intensity.

5.3 *Bird migration intensity and weather: modelling for selected species*

Modelling the relation between bird migration intensity and weather has been carried out to indicate which species are in fact largely influenced by weather parameters, and which species may be less dependent. In addition it should also help to understand influences of weather at the local and regional level in order to identify potential risky situations for bird migration, such as time periods or locations of increased collision risks.

For the selected species the influence of weather parameters and general atmospheric circulation on the migration intensity, as measured by visual observations, were analysed using models. For the spring and autumn migration in 2009 a detailed description of the relations between weather parameters and the occurrence of migration peaks is presented along with the models of migration intensity based on these weather parameters. Results of the modelling are presented separately for 2009 and for both 2009-2010 for each species. Detailed information of the structure and performance of the models can be found in Appendix A.9.

Selection of model species

The first step of creating a mathematical model of migration across the chosen area is the selection of species to include into analysis. The species should satisfy several criteria:

1. It should be numerous enough to provide good quality numeric data;
2. It should be easily identified from a distance in order to minimise observer errors;
3. It should be a transit species in order to avoid the mixture of individuals at different stages of their annual cycle such as wintering or breeding;
4. It should consist of only one biogeographic population in the region as different biogeographical populations might have different migration requirements;
5. It should be a diurnal migrant because the main data will be from daytime visual observations.

As an additional selection criterion it was chosen to find at least one species per migration strategy (type 1 to type 4 – see chapter 1). As migration intensities rely on visual observations, clearly a type 4 species (night-time migrant) would not be included.

In most regions of Europe, mostly in the areas with intensive genesis of cyclones, bird migration shows a pattern of migration peaks followed by pauses between

them. Due to the varying weather conditions and the existence of migration barriers like water bodies or deserts, weather becomes an important factor to “help” the birds across. Weather also plays a role for long distance migrations like e.g. those of wader species which sometimes fly very long distances without using stepping stones and have to rely on favourable weather to arrive at their destinations (e.g. Pennycuick and Battley 2003, Green et al., 2004, Shamoun-Baranes et al., 2010). In contrast, in areas with stable weather conditions, like in the steppes of Central Asia, bird migration shows no clear waves of migration, thus the dynamics of migration of each species is more or less solely under control from the endogenous programmes (Dolnik 1990).

In the Fehmarnbelt region, favourable weather situations regarding bird migration could be characterised by following features (Richardson 1978, Alerstam 1993):

1. Autumn, drop of temperature (migration initiation, winter flight), NE wind (cold front of the cyclone, favourable tailwinds)
2. Spring, rise of temperature, SW wind (warm front of the cyclone, tailwinds)

This applies mainly for short distance migrants, which are less dependent on endogenous programmes and thus able to react to weather conditions. In contrast, long distance migrants are more tied to migration schedules, being more under time pressure and thus less flexible with regard to weather conditions. Consequently they migrate later in spring and earlier in autumn (Figure 5.20, Hüppop and Hüppop 2011), in this way at least making use of milder weather conditions during their migration times.

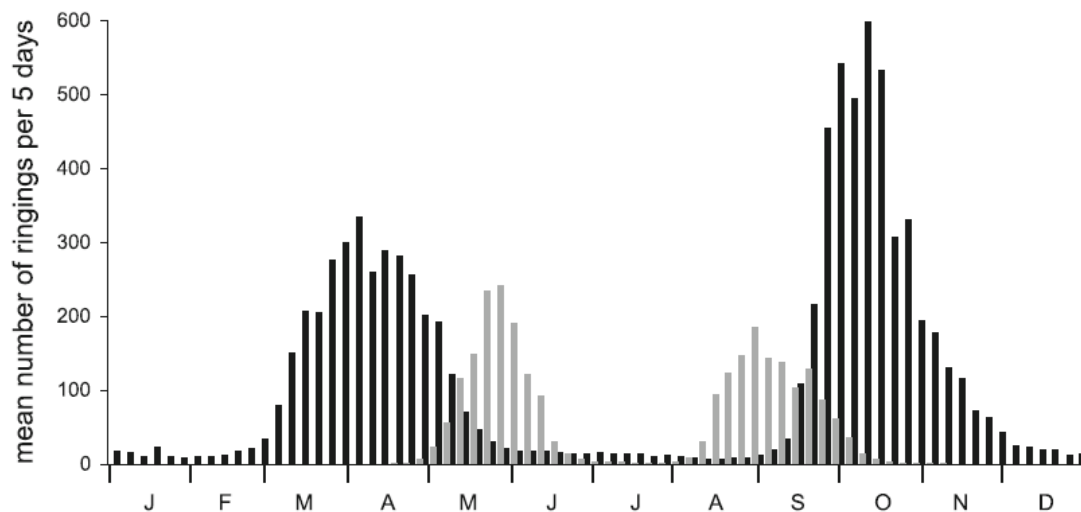

Figure 5.20 Annual phenologies of the short/medium distance migrants (black columns) and the long-distance migrants (grey columns) in the trapping garden on Helgoland from 1960 to 2008 (Hüppop and Hüppop 2011).

5.3.1 Common Eider

Common Eider, a type 1 species preferentially migrating over water, is one of the most numerous waterbird species registered in the Fehmarnbelt with the estimated size of the recent Baltic Sea population is 760,000 individuals (Mendel et al., 2008). In the beginning of the 1990s the Baltic population comprised about 1.2 million individuals (Desholm et al., 2002). 370,000 birds winter in Danish waters (Desholm et al., 2002). This species offers good opportunities for statistical analyses due to its high abundance in the region. However, Common Eiders are present in the area

FEHMARNBELT BIRDS

throughout the year, thus individuals registered may belong to different stages of their life cycle like wintering, migration and breeding. However, the highest numbers of daily counts clearly belong to migrating flocks during spring and autumn migration.

Large proportions of the Common Eiders wintering in Fehmarnbelt area are short distance migrants breeding along the northeast coast of the Baltic Sea (Figure 5.21). As a short distance migrant Common Eiders are less dependent on the endogenous migratory programmes and more dependent on regional and local weather conditions (Berthold 2001).

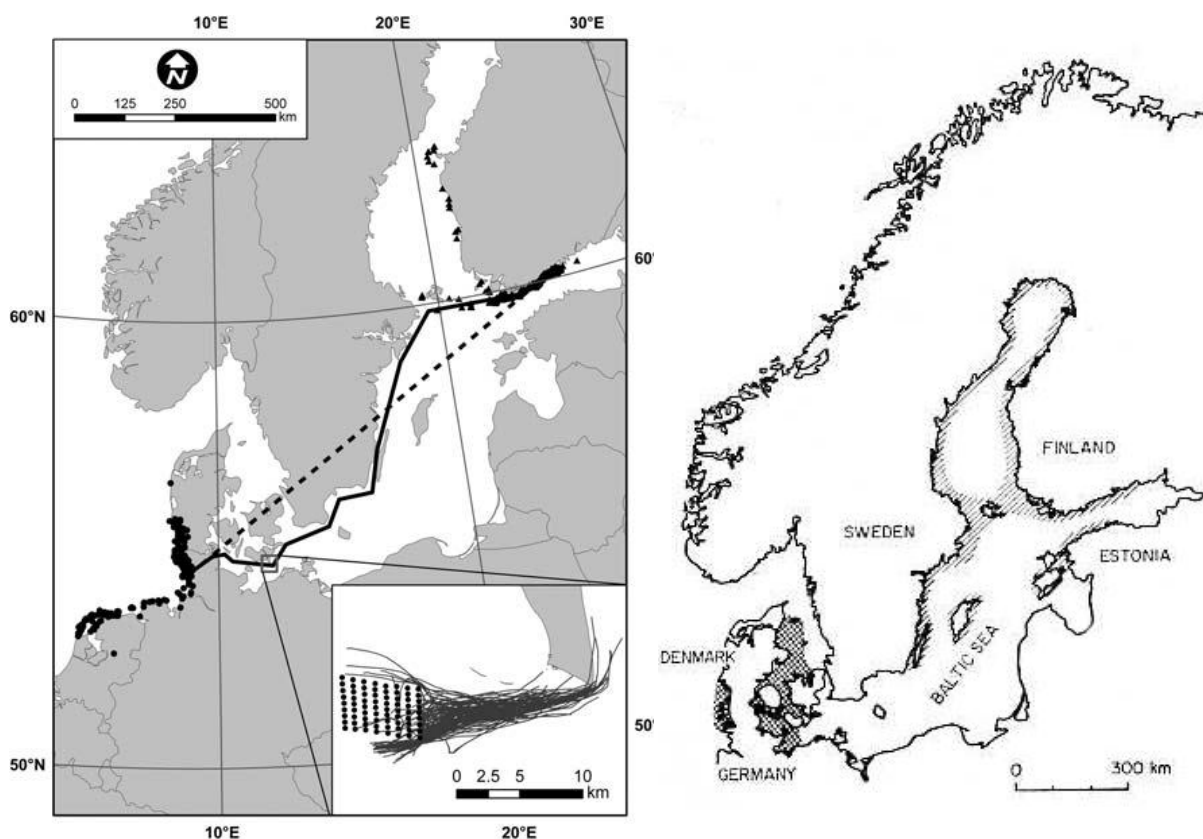

Figure 5.21 Left: Proposed Common Eider migration routes compared with the corresponding straight-line distance (dashed line); triangles represent capture sites of breeding adult females in Finland, and circles the recovery sites of these birds in winter in the Wadden Sea (Masden et al., 2009). Right: Wintering (cross-hatched) and breeding (hatched) area of Baltic population of the Common Eiders (Alerstam et al., 1974).

Although Common Eiders clearly prefer to fly over water during migration, they are known to cross land masses. A large scale study of the spatial-temporal pattern of spring migration of Common Eider was undertaken by the Swedish Air Force simultaneously at three radar stations and ten field observation sites in 1972 (Alerstam et al., 1974). Common Eiders wintering in Danish and West German waters start spring migration on courses ranging from SE to NE. Those from the northern part of the wintering area flew SE, those from the southern wintering area flew NE, while birds wintering in between these geographical extremes chose an intermediate course around E. Radar results showed that most Common Eiders flew over the Danish island of Zealand and the Swedish peninsula of Skåne, but only exceptionally further north over Sweden (Figure 5.22). Few Common Eiders crossing land were registered by field observers and most evidently passed at high altitudes beyond the range of vision. After having crossed Skåne on varying tracks, the eiders descended and changed flight direction towards NE.

FEHMARNBELT BIRDS

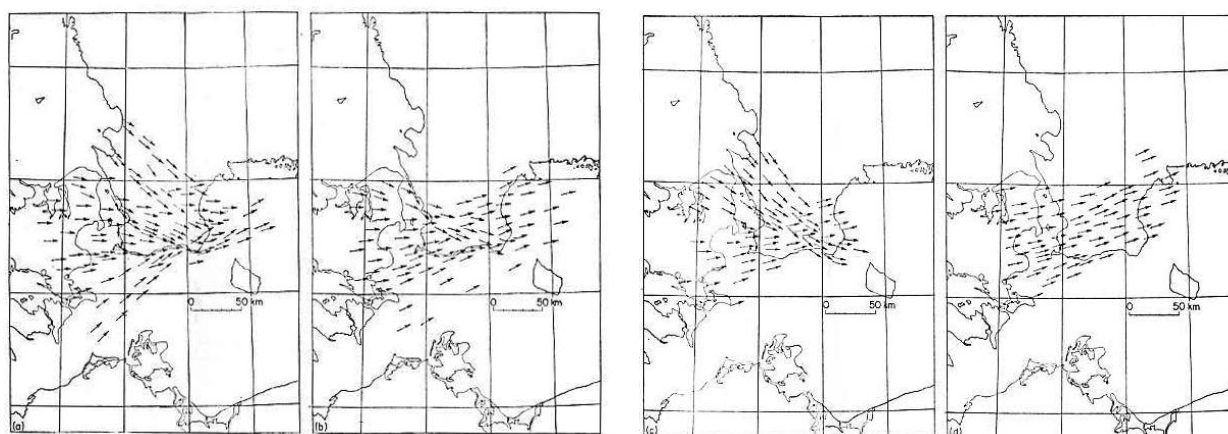

Figure 5.22 Examples of Eider migration in the area of Skåne, southern Sweden, as shown by radar and visual observations. From left to right: April 7, morning; April 13, morning; April 12, 19:00 - 22:00 h; April 14, 19:00 - 22:00 h (Alerstam et al., 1974).

After having passed Skåne no significant land crossings are made. Approximately 350,000 migrating Common Eiders have been registered during daytime, 250,000 crossing the land of Skåne while 100,000 passed along the south coast. Almost 300,000 migrated north through the Kalmarsund and some 17 % passed east of the island of Öland over the open sea. Three distinct peaks of activity during the day were noted in Skåne. The first one at around sunrise, originated from birds resting in waters west of Skåne. The second peak occurred about four hours later and probably consisted of birds which had departed from the wintering areas further west in the early morning. A final peak at sunset was often recorded. Migration also took place during the night, but involved only 20 % of the total number (Alerstam et al., 1974).

Results of the current satellite telemetry of Common Eiders support the radar observations from some 40 years ago. Figure 5.23 shows one example track of a bird marked during the Fehmarnbelt project, crossing Danish Zealand on its migration to the breeding grounds (for more details own satellite telemetry results on Common Eiders see FEBI Volume II - Aerial and ship-based surveys from autumn 2008 to spring 2009).

FEHMARNBELT BIRDS

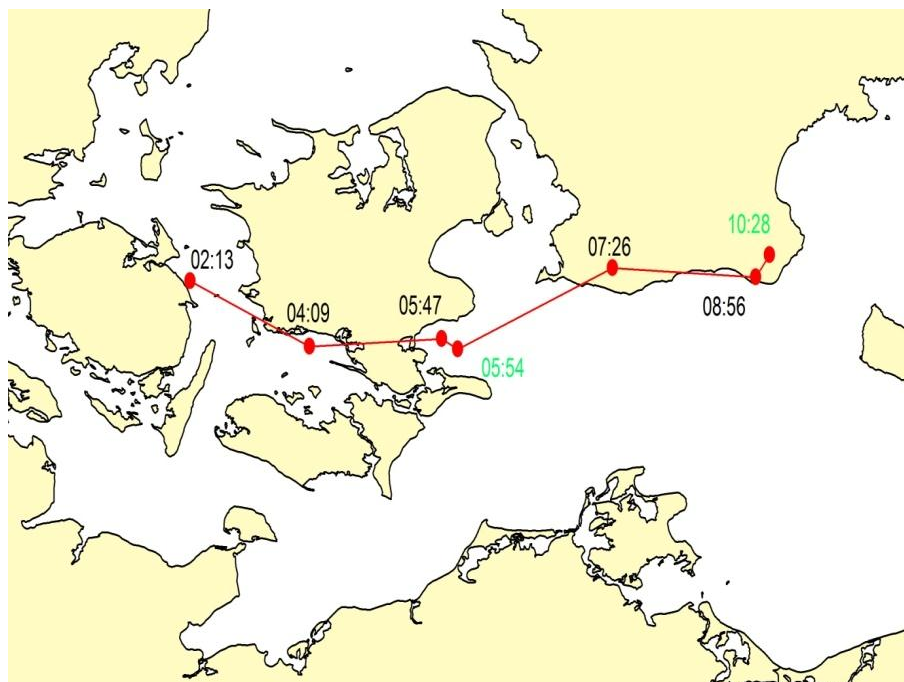

Figure 5.23 The track of one Common Eider individual during April 18, 2009. Time (UTC) of positioning is shown at each location point (see text for details).

Migration of Common Eiders is known to be under strong influence of weather, wind characteristics are most important. Studies show, that among-day variation in movement rates is high, with birds apparently flying at any time if migratory conditions were favourable. Movement rates are significantly higher during good visibility than poor visibility, higher during tailwinds than crosswinds and headwinds, higher during strong compared to weak crosswinds and higher during weak compared to strong headwinds. Visual and radar observations at Barrow, Alaska, found that Common Eiders migrate with an average speed of 83 km/h, depending on wind conditions (e.g. Day 2004), other studies report 72 km/h (Pennycuik 2001).

Spring 2009

While both sexes share the wintering grounds for mating, at onset of migration in late winter / early spring males follow females irrespective of their own origin (Spurr and Milne 1976). During spring, the intensity of migration of Common Eider was observed to be 6 times higher along the Lolland coast compared to the Fehmarn coast (280,000 vs. 47,000 registered birds; Figure 5.24). Pronounced peaks of spring migration at Lolland and Fehmarn were detected during the periods of southerly and westerly winds (Figure 5.25, Figure 5.26). The largest peak of migration at Lolland occurred on a day with mean wind direction 244° which is the best tailwind for the migration along the western coast of the SW Baltic Sea (Skåne and Öland).

FEHMARNBELT BIRDS

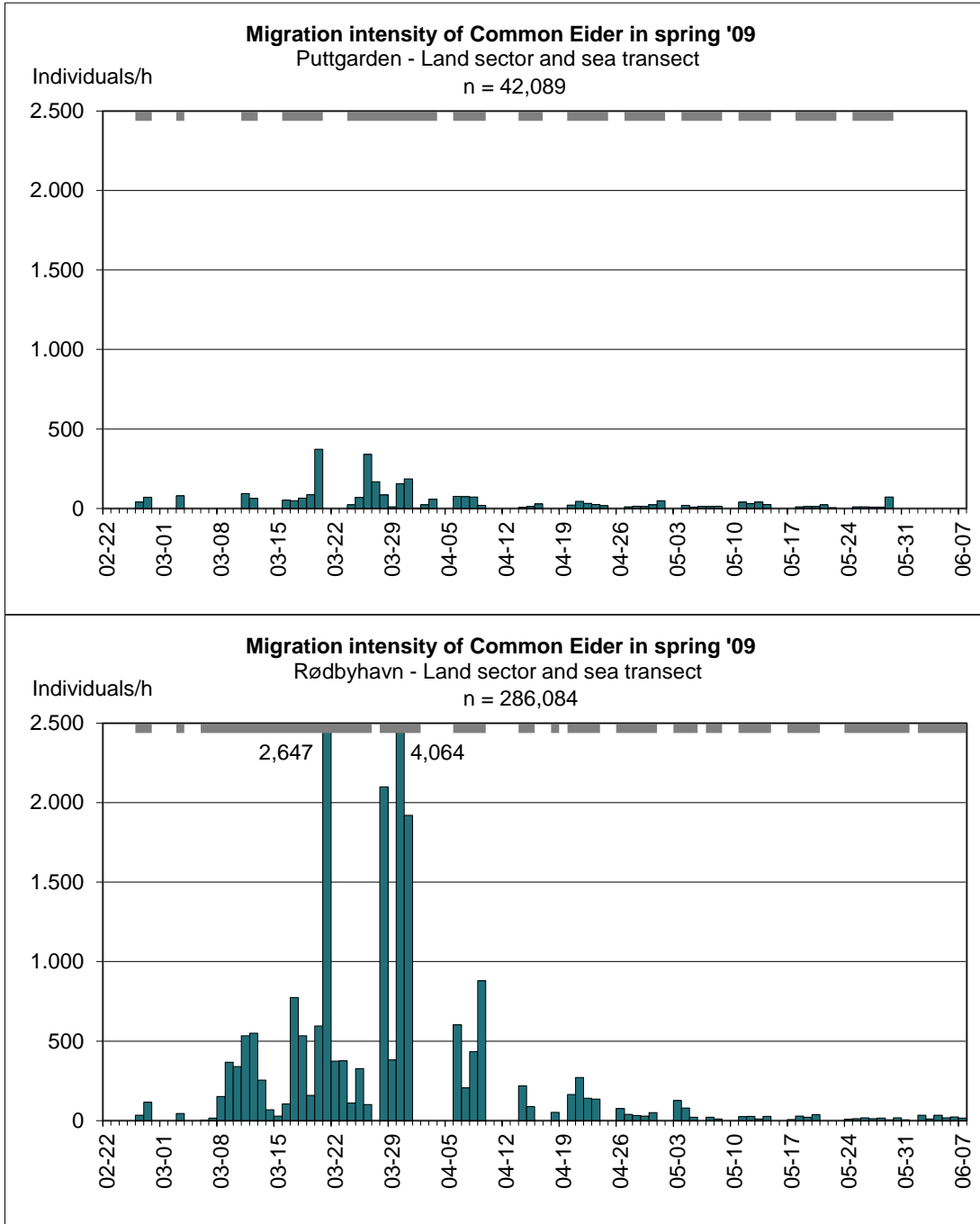

Figure 5.24 Seasonal dynamics of spring migration of Common Eider at Puttgarden (top) and Rødbyhavn (bottom). Days covered are indicated in grey on the upper axis.

FEHMARNBELT BIRDS

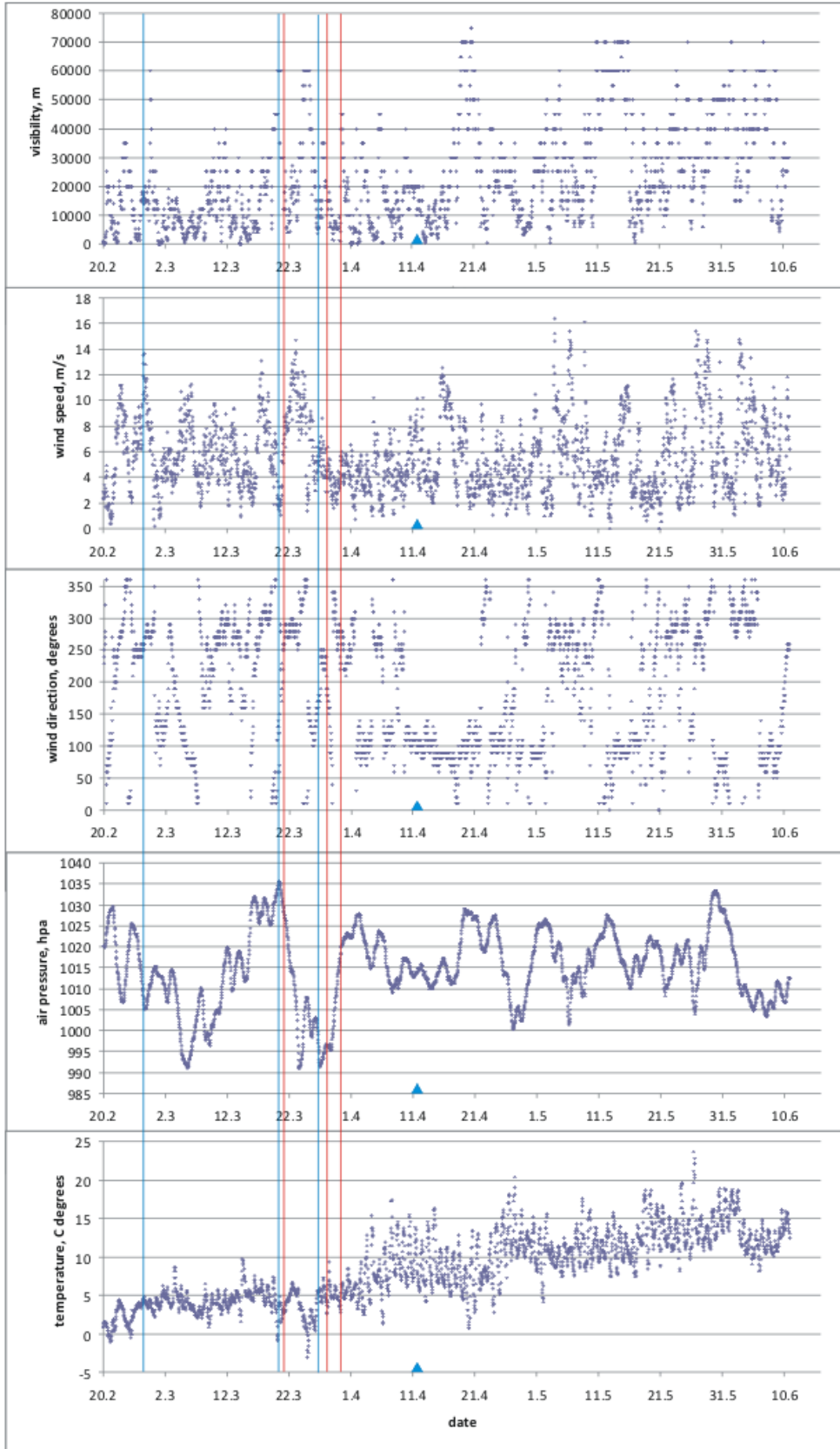

Figure 5.25 Occurrence of three strongest spring migration peaks of Common Eiders at Puttgarden (blue lines) and Rødbyhavn (red lines) in relation to weather parameters. Blue triangle shows mean passage date on Fehmarn (OAG database).

FEHMARNBELT BIRDS

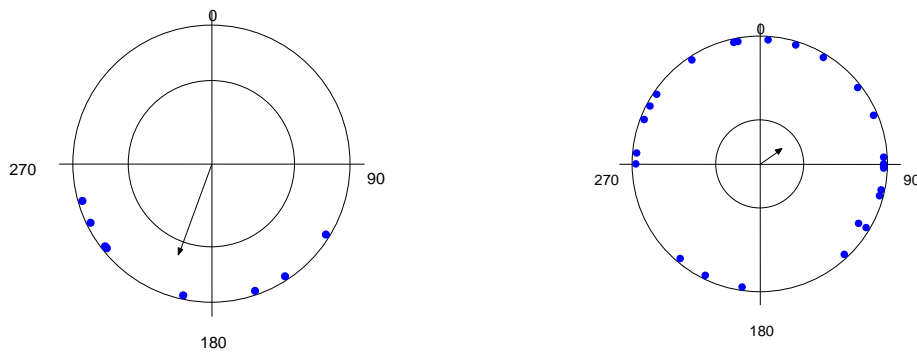

Figure 5.26 Relation between wind direction and spring migration intensity of Common Eider at Fehmarn. Days with 90 % of total numbers are present, left – days with 60 % of birds (maximal peaks), right – the rest of days with weak migration. Inner circle shows the 95% confidence interval for the mean wind direction. The direction is significant when the arrow of mean direction is longer than inner circle showing the confidence interval.

For the Fehmarn data three parameters of the GAM (Julian day, wind vector projections, and temperature) explain 83 % of the variation of spring migration intensity. For Lolland, where higher numbers of Common Eider were registered, the best model with four parameters (Julian day, wind direction, wind speed and visibility) explains 49 % of the variation of Common Eider spring migration intensity (see Appendix A.9).

Autumn 2009

In autumn, the number of registered migrating Common Eiders was about two times higher at Fehmarn than at Lolland (117,000 vs. 65,000 birds). The largest peaks of eider autumn migration occurred after a decrease of air temperature during several days (Figure 5.29), a good reason to include temperature trend in the model.

Dynamics of autumn migration of Eiders across the area is shown on Figure 5.27. Maximal peaks of migration happened with E / SE winds at Lolland and N / NE winds at Fehmarn. This suggests the influence of the wind in selection of migratory routes or coasts of the Fehmarnbelt by Common Eiders during autumn migration, although for Fehmarn this tendency is not significant (Figure 5.30).

FEHMARNBELT BIRDS

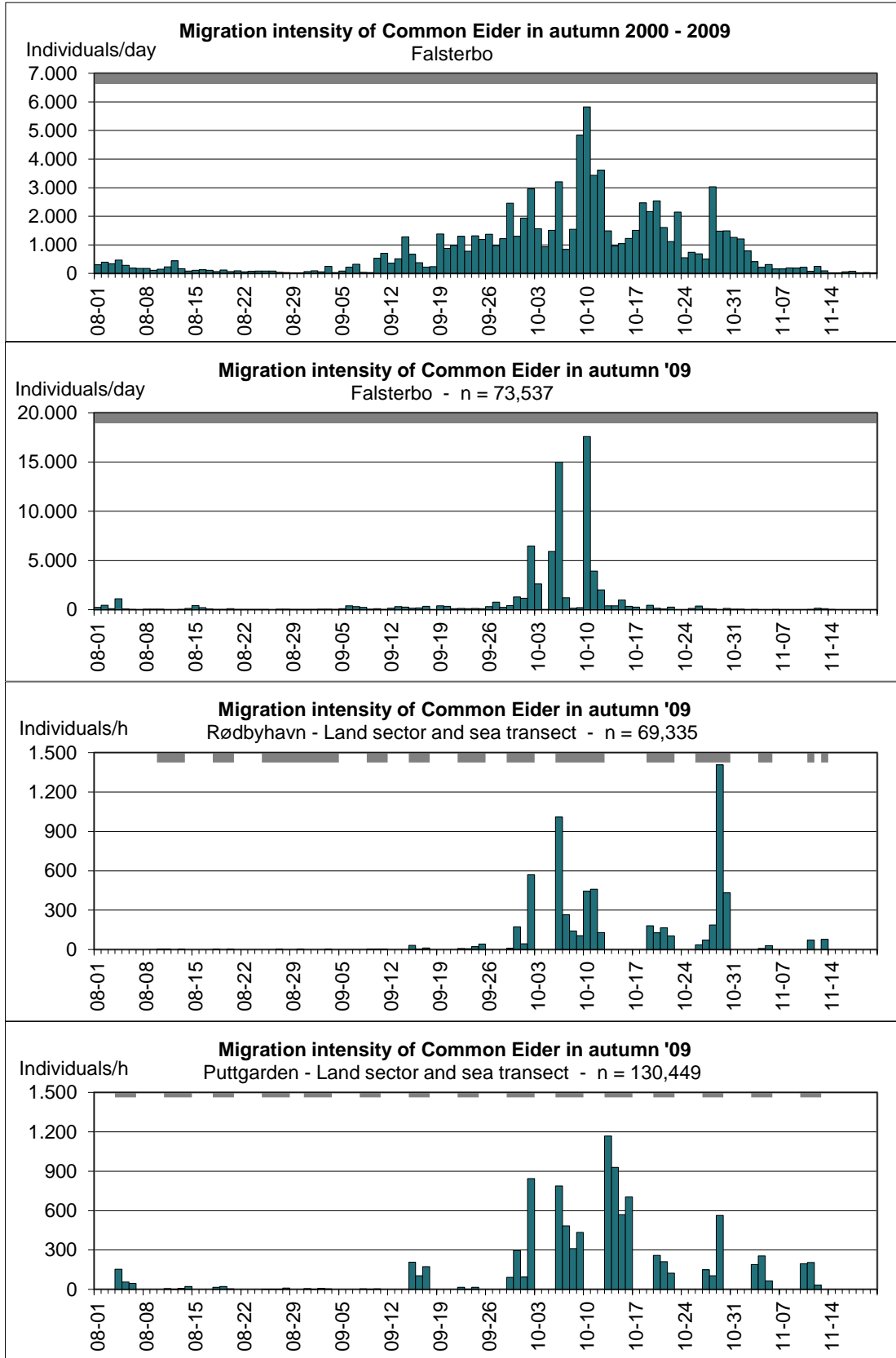

Figure 5.27 Seasonal dynamics of autumn migration of Common Eider in at Falsterbo (average 2000-2009 and 2009; top), Puttgarden (middle) and Rødbyhavn (bottom). Days covered are indicated in grey on the upper axis.

FEHMARNBELT BIRDS

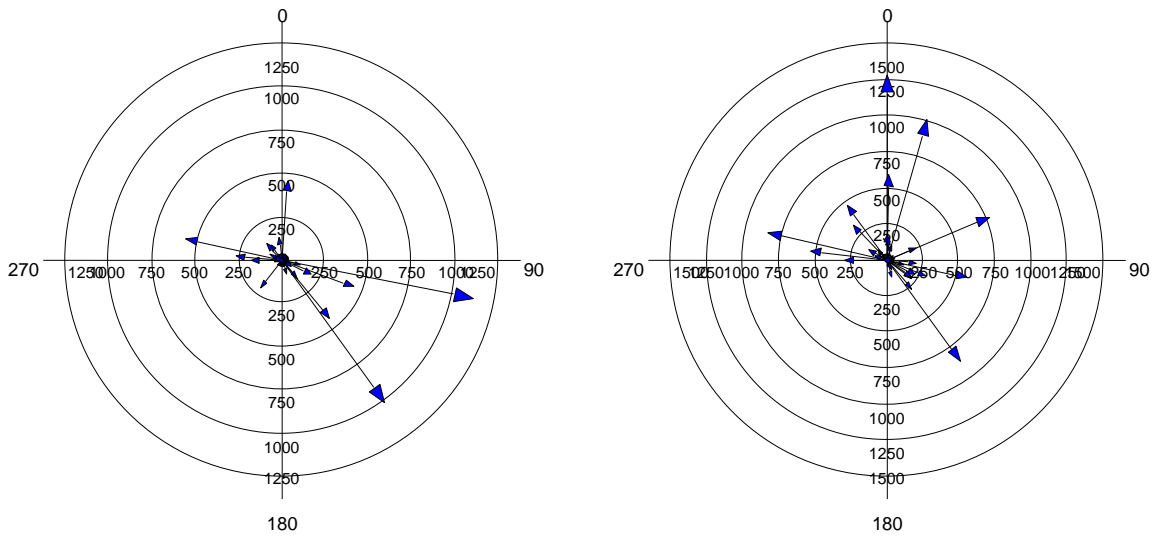

Figure 5.28 Relationship between wind direction and migration intensity of Common Eider during autumn 2009 at Lolland (left) and Fehmarn (right). Intensities were grouped in the 10 degrees sector of wind direction; the length of the arrow represents the intensity of migration, arrow is pointed to where the wind is blowing from.

FEHMARNBELT BIRDS

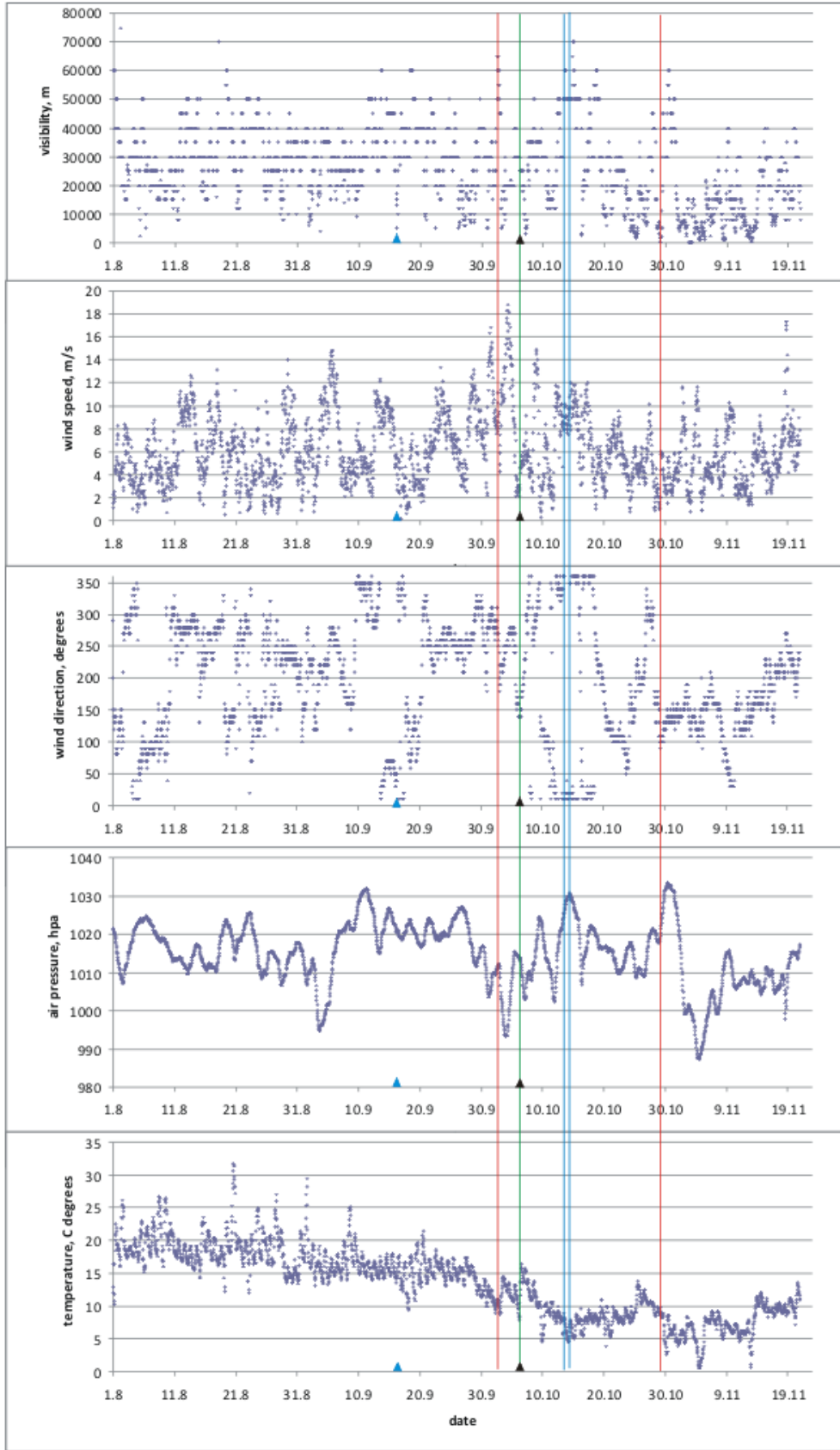

Figure 5.29 Occurrence of migration peaks of Common Eiders in relation to weather parameters. Three days of peak migration selected for both Lolland (red lines) and Fehmarn (blue lines); green lines show peaks on both sides. Black triangle shows mean passage date on Falsterbo (10 years), blue triangle the median passage date on Fehmarn (10 years, OAG data).

FEHMARNBELT BIRDS

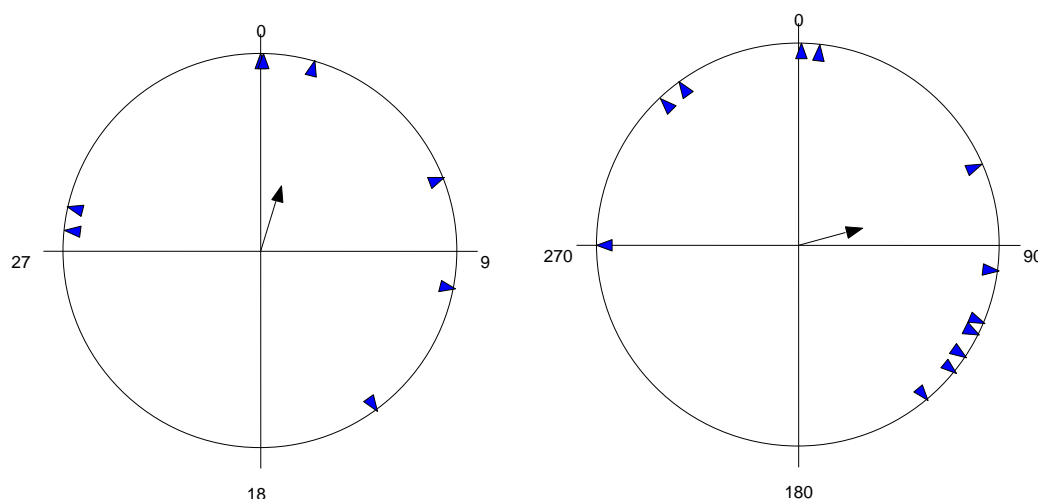

Figure 5.30 Relation between wind direction and autumn 2009 migration intensity of Common Eider at Fehmarn. Days with 90 % of total numbers are presented, left – days with 60 % of birds (maximal peaks), right – the rest of days with weak migration. Directions in both cases are not significant.

Model results autumn 2009

The GAM on Common Eider migration intensity in autumn at Puttgarden includes three parameters – Julian day, wind vector projections and trend of the temperature change in the previous 2 days – and explains 96 % of the variation, which suggests an overfitting of the model. After adding data from the second year the tendency to overfitting became smaller (see below). At Lolland the best model includes three parameters - Julian day, wind projections and cloud altitude. These parameters explain 84 % of the variation of migration intensity (see Appendix A.9). The intensity of migration at Fehmarn increases during northerly winds, while maximum migration intensities at Lolland were found during south-easterly winds.

Results 2009/2010

The model is based on the results of the visual observations of both years of baseline investigations in 2009 and 2010.

In spring, the best model explains 53 % of the variation of migration at Lolland with parameters Julian day, projection of the wind vector and trend of changing temperature during the last 2 days (see Appendix A.9). Both increasing and decreasing temperatures seem to stimulate migration which may be related to the dependency between the Common Eider migration and cyclonic activity. At Fehmarn the best model also explains 53 % of the variation with parameters Julian day, projection of the wind vector and visibility (see Appendix A.6).

In autumn, the best model of migration at Fehmarn explains 77 % of the variation with parameters Julian day, wind direction (sin and cos), wind speed and precipitation during morning (6-12 am). NE winds favour the migration. At Lolland the best model explains 39 % of the variation with parameters Julian day, projections of wind vector and visibility (see Appendix A.9).

The influence of one of the most important weather parameters, wind direction, on the intensity of migration of Eiders is shown on Figure 5.31.

The percentage of explained variation decreased when the model was run on the larger dataset of two years observations, also the combination of the parameters

FEHMARNBELT BIRDS

included into the model changed, but Julian day and wind direction were included into the model in both cases of 2009 and 2009-2010.

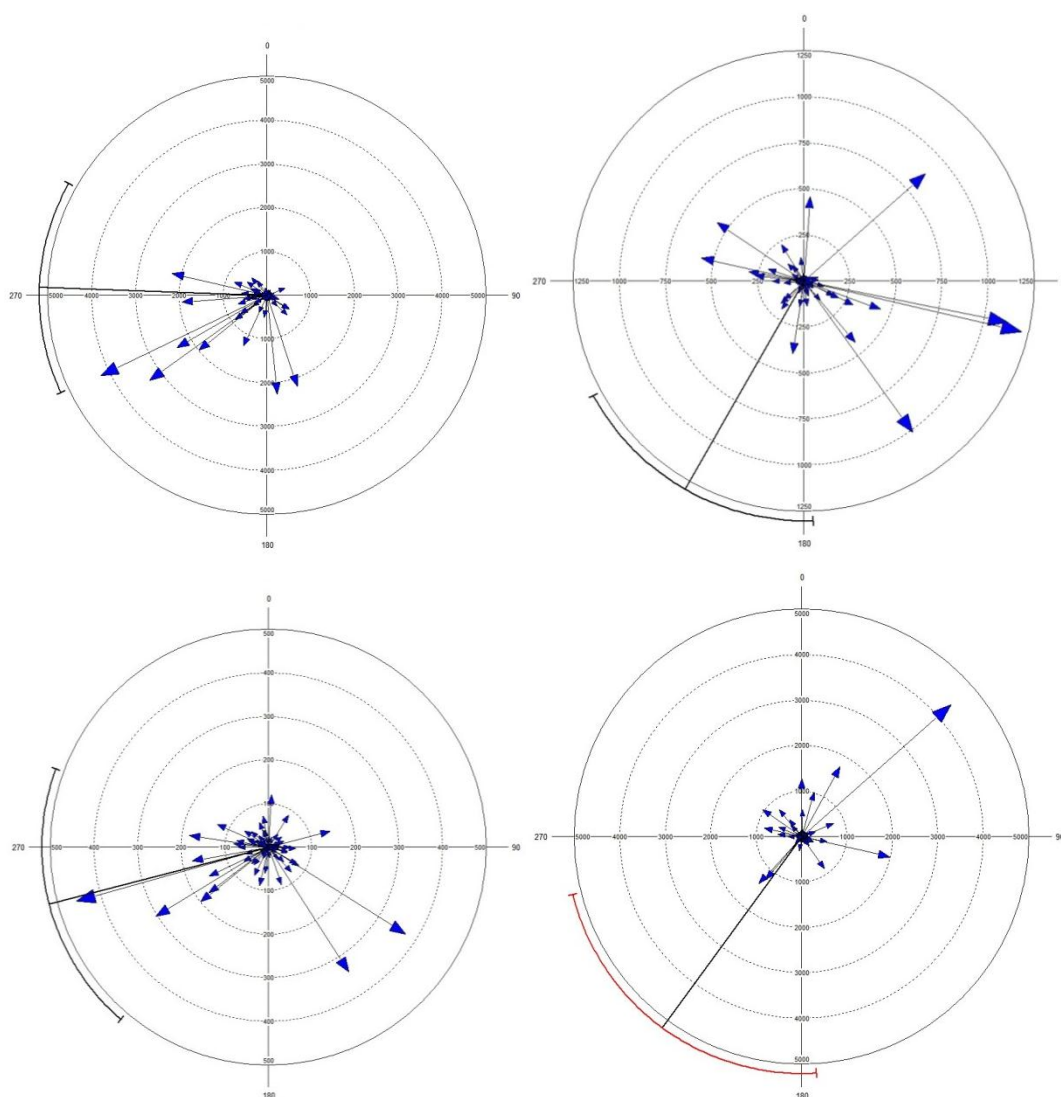

Figure 5.31 Relation between migration intensity of the Common Eider at Lolland (upper charts) and Fehmarn (lower charts) in spring (left) and autumn (right) and wind direction, 2009-2010. Black line shows the mean direction of wind for the entire migration period, the arc at the end of it is black when the direction is significant and red when direction is non-significant. For details see Figure 5.31.

Discussion

Comparing visual observations at the land stations with the ones at the offshore station pointed out that Common Eiders prefer to migrate close to the coast (see chapters 4.2 and 4.3). During spring migration wind direction was the main parameter explaining the migration intensity. Common Eiders – being one of the heaviest ducks – take advantage of the tailwinds. During autumn migration wind direction played a role in regulating the number and the distribution of migrants at both sides. Maximum peaks of migration occurred at Puttgarden during northerly winds, while peaks at Lolland occurred during south-easterly winds. In addition, the

decrease of the air temperature in autumn seems to be one of the triggers of the migration of this species to the wintering grounds.

A proportion of Common Eiders migrates at night (see Figure 5.23 and Alerstam et al., 1974). However, as communication / flight calls of this species do not exist, those could not be registered by species by any method.

5.3.2 Barnacle Goose

The Barnacle Goose represents a type 2 species, less reliant on migrating over water. Its population is estimated to 420,000 individuals (Wetlands International 2006), yet recent updated estimates are as high as 780,000 individuals (Fox et al., 2010). While for a long time the most western breeding grounds of this species were on the Swedish island of Gotland, most recently there are several breeding colonies established in the Netherlands, Germany and Denmark (Feige et al., 2008), but most of Barnacle Geese wintering in northern continental Europe still breed in the Russian Arctic (Figure 5.32). The Fehmarnbelt is located within the southern range of their flyway between the wintering areas at the Wadden Sea and the stop-over sites at the Baltic Sea coast (Figure 5.33).



Figure 5.32 Migratory flyway of the Russian population of the Barnacle Goose *Branta leucopsis*, determined from ring recoveries (1965–2003) and results from satellite telemetry autumn 2004 - spring 2005 (Drent et al., 2007). PTT spring / fall – signals from satellite transmitter in spring and autumn, respectively.

FEHMARNBELT BIRDS

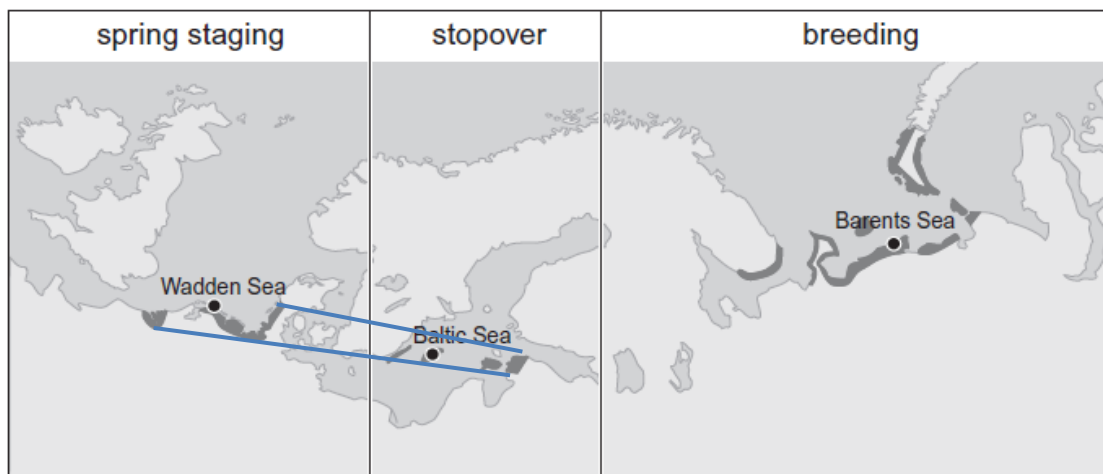

Figure 5.33 Spring staging, stop-over and breeding sites of Barnacle Geese wintering in continental Europe. Blue lines show the migratory flyway between spring staging areas and stop-over sites at the Baltic Sea (from van der Graaf 2006, with modifications)

Spring 2009

During spring 2009, four migration peaks of Barnacle Goose were recorded, where most of the birds were registered at the Lolland coast of the Fehmarnbelt (Figure 5.34) which reflects the geography of the flyway as displayed in Figure 5.33. Some 51,000 individuals were registered flying over the Rødbyhavn station (Lolland), representing some 5-10 % of the flyway population. As there are only a few data points, sample size is too small to perform the modelling, but data suggest, that Barnacle Geese migrate through the Fehmarnbelt area with tailwinds (e.g. chapter 4.3.2). The peak of spring migration 2009 was recorded at both stations on May 7, 2009 with about 1,500 birds/hour on Lolland during strong (10-15 m/s) westerly winds over large part of Northern Europe during previous days (Figure 5.35, Figure 5.37).

FEHMARNBELT BIRDS

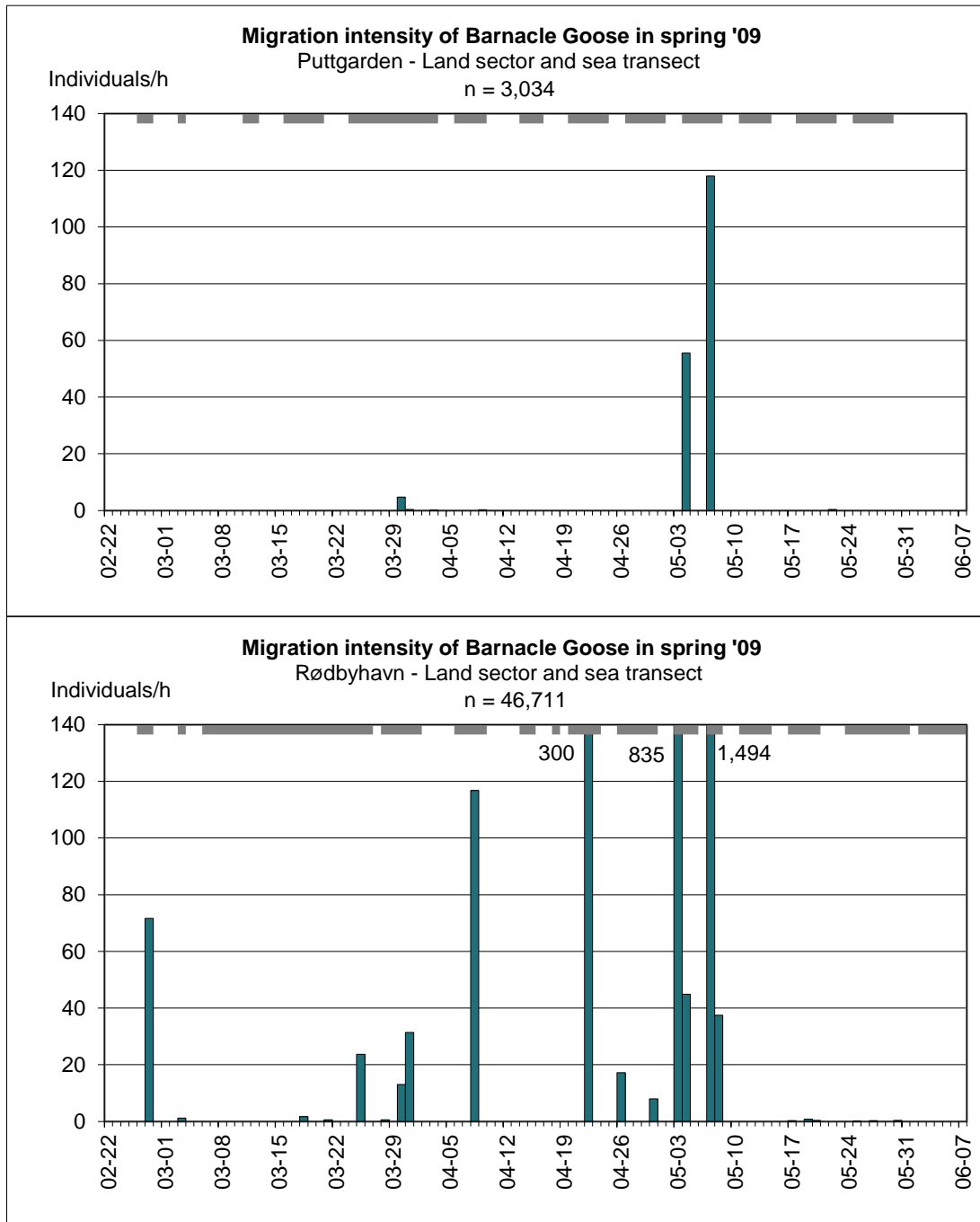

Figure 5.34 Dynamics of spring migration 2009 of Barnacle Goose at Puttgarden (top) and Rødbyhavn (bottom). Days covered are indicated in grey on the upper axis.

FEHMARNBELT BIRDS

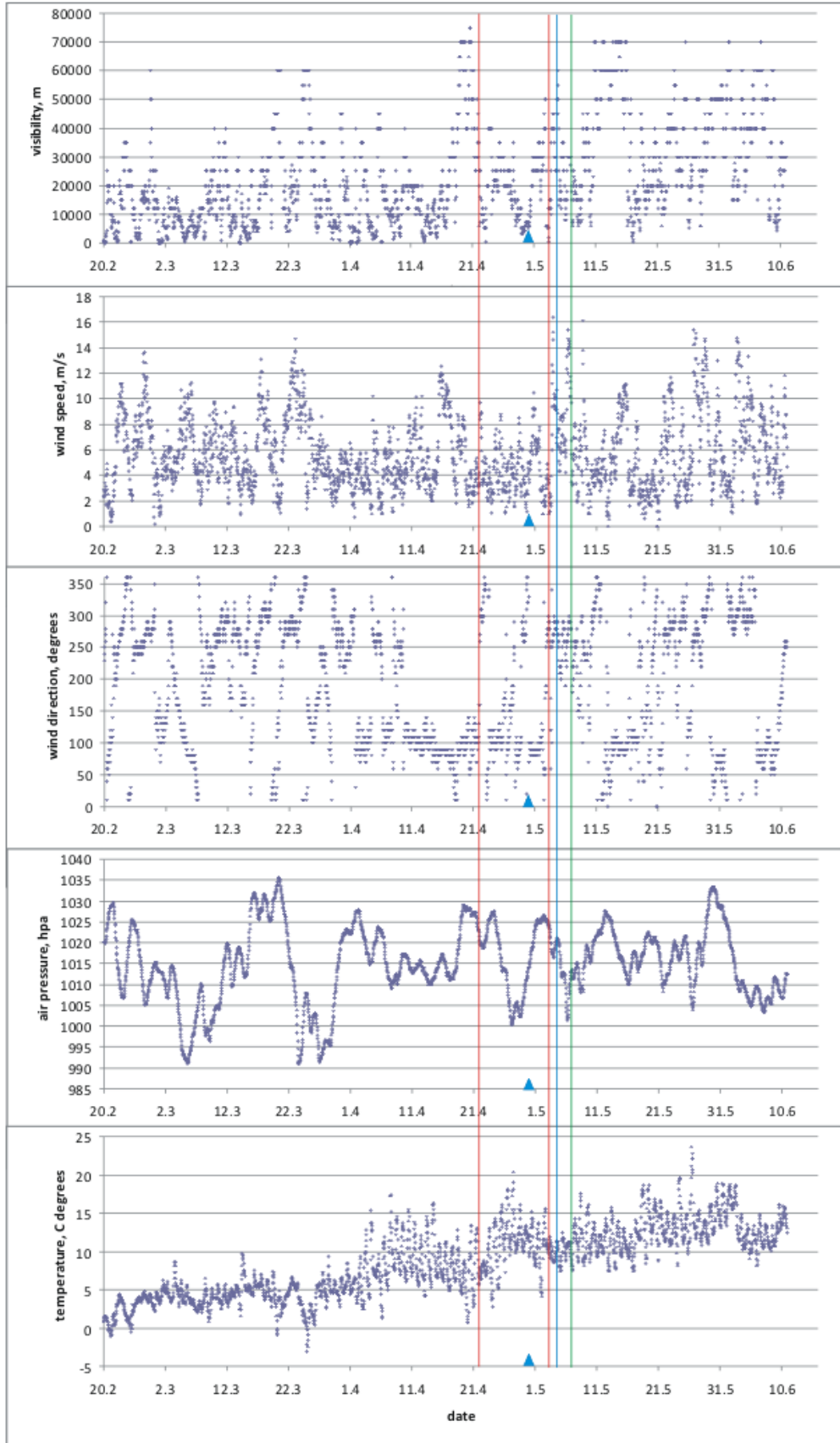

Figure 5.35 Occurrence of three strongest spring migration peaks of Barnacle Goose at Puttgarden (blue lines), Rødbyhavn (red lines) in relation to weather parameters, or both Puttgarden and Rødbyhavn (green line). Blue triangle shows mean passage date on Fehmarn (OAG database).

FEHMARNBELT BIRDS

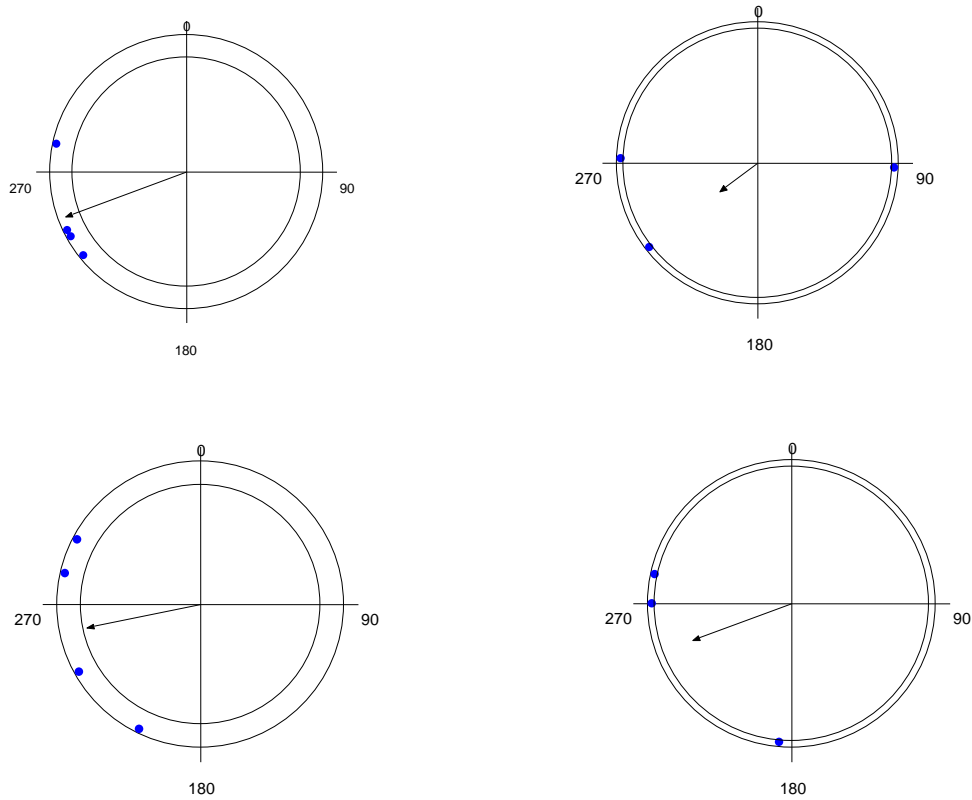

Figure 5.36 Wind direction and intensity of Barnacle Goose spring migration at Fehmarn (top) and Lolland (bottom); left - peak days, right - the rest of the days. Inner circle shows the 95% confidence interval for the mean wind direction. The direction is significant when the arrow of mean direction is longer than inner circle showing the confidence interval.

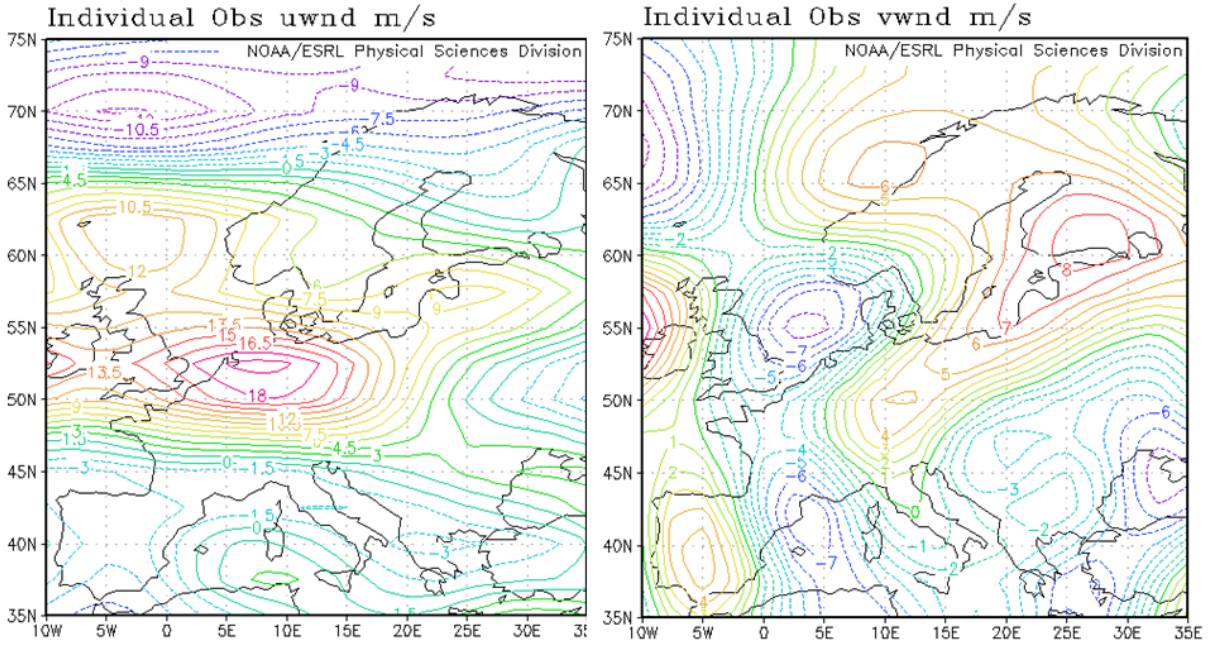

Figure 5.37 Map of wind conditions over Europe on May 6, 2009 6:00 UTC, a day before peak migration of Barnacle Goose, left - westerly (u) and right - southerly (v) wind components. Note the large area of strong WNW winds SW of Utland peninsula. Wind speed is represented by isolines connecting areas with the same values of speed. The Figure is produced online using NOAA site (see Methods).

FEHMARNBELT BIRDS

Autumn 2009

In autumn 2009 migratory peaks of Barnacle Goose were more numerous as in spring (Figure 5.38), especially on the northern part of the Fehmarnbelt at Lolland, but total numbers were lower. The relation between weather parameters and intensity of autumn migration of Barnacle Goose is shown in Figure 5.39.

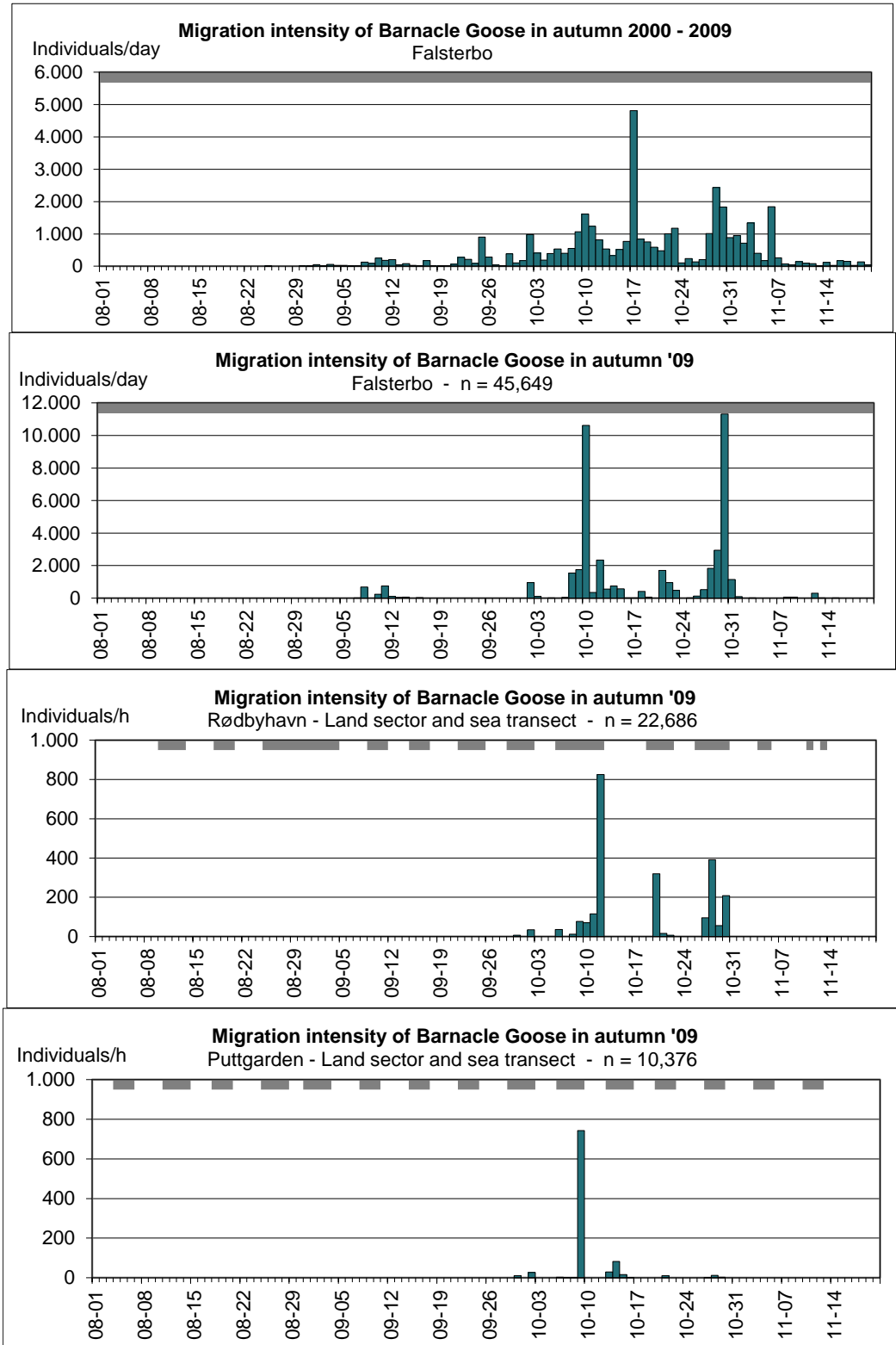

Figure 5.38 Dynamics of autumn migration 2009 of Barnacle Goose at Falsterbo (average 2000-2009 and 2009; top), Puttgarden (middle) and Rødbyhavn (bottom). Days covered are indicated in grey on the upper axis.

FEHMARNBELT BIRDS

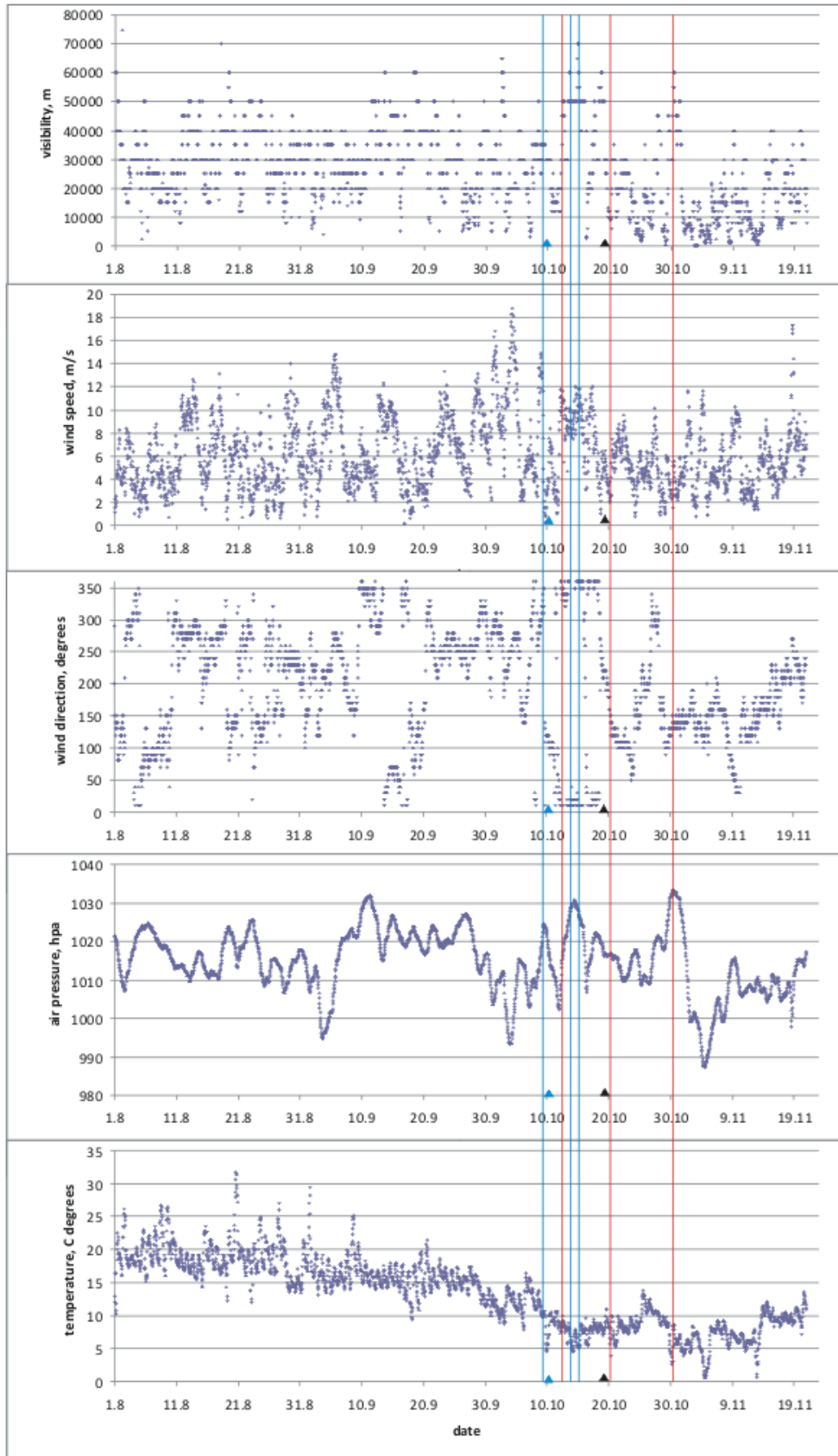

Figure 5.39 Occurrence of three strongest autumn migration peaks of Barnacle Goose at Puttgarden (blue lines), Rødbyhavn (red lines) in relation to weather parameters, or both Puttgarden and Rødbyhavn (green line). Blue triangle shows mean passage date on Fehmarn (OAG database). Black triangle shows mean passage date at Falsterbo.

FEHMARNBELT BIRDS

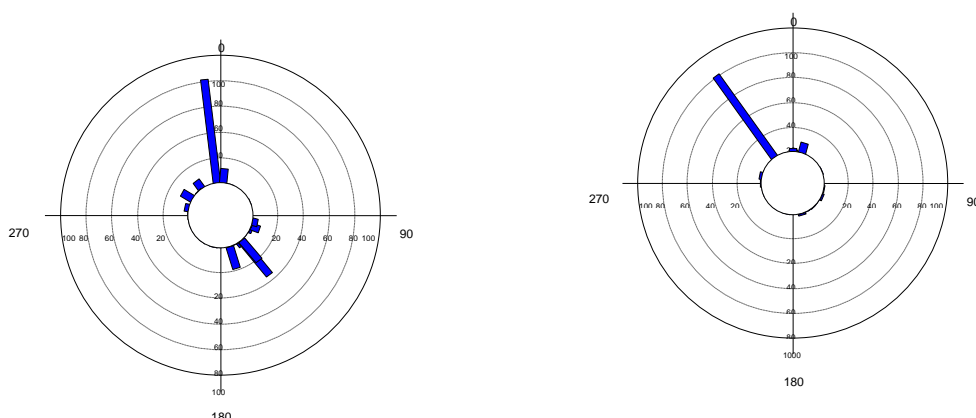

Figure 5.40 Wind direction and intensity of autumn migration of Barnacle Goose, left – Lolland, right – Fehmarn.

The chosen model of autumn migration at the Fehmarn coast with three parameters included (Julian day, wind direction and speed) explains 95 % of the variation. The best model of autumn migration at the Lolland coast with set of 3 parameters (Julian day, wind projection and temperature) explains 90 % of the variation (see Appendix A.9). Large numbers of Barnacle Geese were registered during wind coming from NNW, while Barnacle Geese were observed at the southern part of Fehmarnbelt only during northerly winds (Figure 5.40). This wind dependency and the fact that birds are more numerous at Lolland than at Puttgarden (Figure 5.38) may reflect the gradual decrease of the number of migrants further away from the main flyway (Figure 5.32, Figure 5.33), which is considered to be on a straight line as there are neither stop-overs en route nor a dependency on land or water during migration.

Results 2009/2010

Nocturnal recordings of Barnacle Goose calls in 2010 confirm that this species migrates intensively also at night, with the intensity of nocturnal migration at Lolland being much higher in comparison to Fehmarn (Figure 5.41). It is important to note, that large numbers of night calls were also recorded at the inland stations 2-3 km from the coast line, and that migration phenologies according to daytime visual observations correspond well to those of night acoustic observations. One mass migration event of Barnacle Goose was recorded during the night 26/27 April 2010, with 4,080 calls registered at the Lolland inland acoustic station. Large number of tracks could be seen on horizontal radar screenshots at Lolland (chapters 4.3.2 and 4.3.3). The direction of tracks is different over land and over sea; while individuals migrating over sea are heading E and ENE, they turn to E and ESE when reaching the coast line, thus running parallel to the coast line over land. That night was characterized by westerly winds with 8 m/s. At the beginning of the night visibility was 1500–3000 m. Another mass migration day was registered on 10 May 2010 (Figure 5.41).

FEHMARNBELT BIRDS

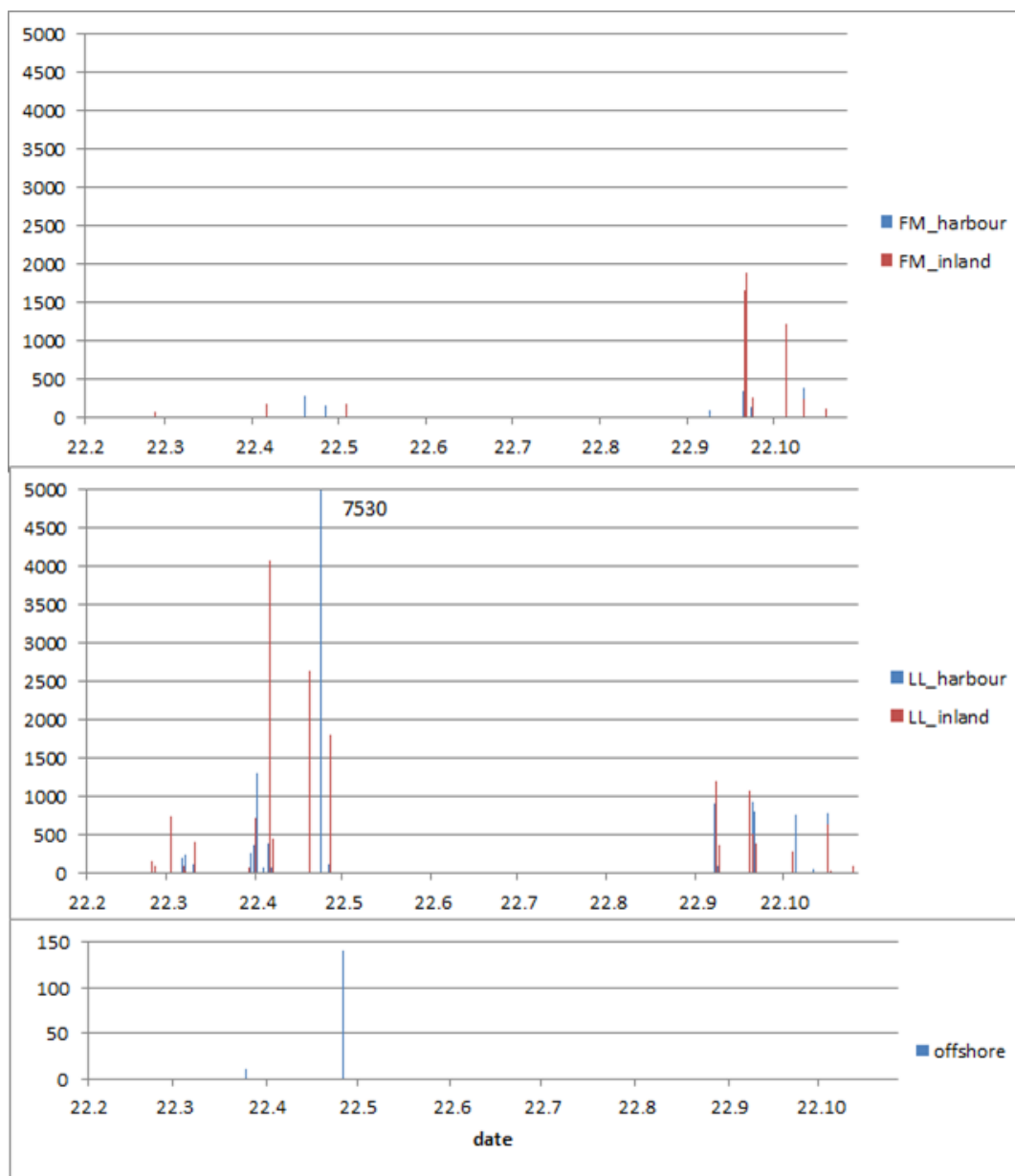

Figure 5.41 Intensity of nocturnal calls of Barnacle Goose at Lolland (LL), Fehmarn (FM) and offshore recording stations in 2010.

For spring migration, the best model explains 18 % of the variation of migration intensity at Lolland with parameters Julian day, wind direction (sin and cos) and wind speed. At Puttgarden the model explains 24 % of the variation with parameters Julian day, projections of the wind vector and precipitation during 6 hours in the morning (6-12 am) (see Appendix A.9). Westerly wind favours the migration at both locations.

In autumn, the best model explains 83 % of the variation at Puttgarden with parameters Julian day, wind direction (sin and cos), wind speed and precipitation during 6 hours in the morning (6-12 am) (see Appendix A.9). At Lolland the best model explains 60 % of the variation with parameters Julian day, projection of wind vector, and temperature. NE wind favours migration at both locations (see Appendix A.9).

The influence of wind direction on the intensity of migration is shown in Figure 5.42.

FEHMARNBELT BIRDS

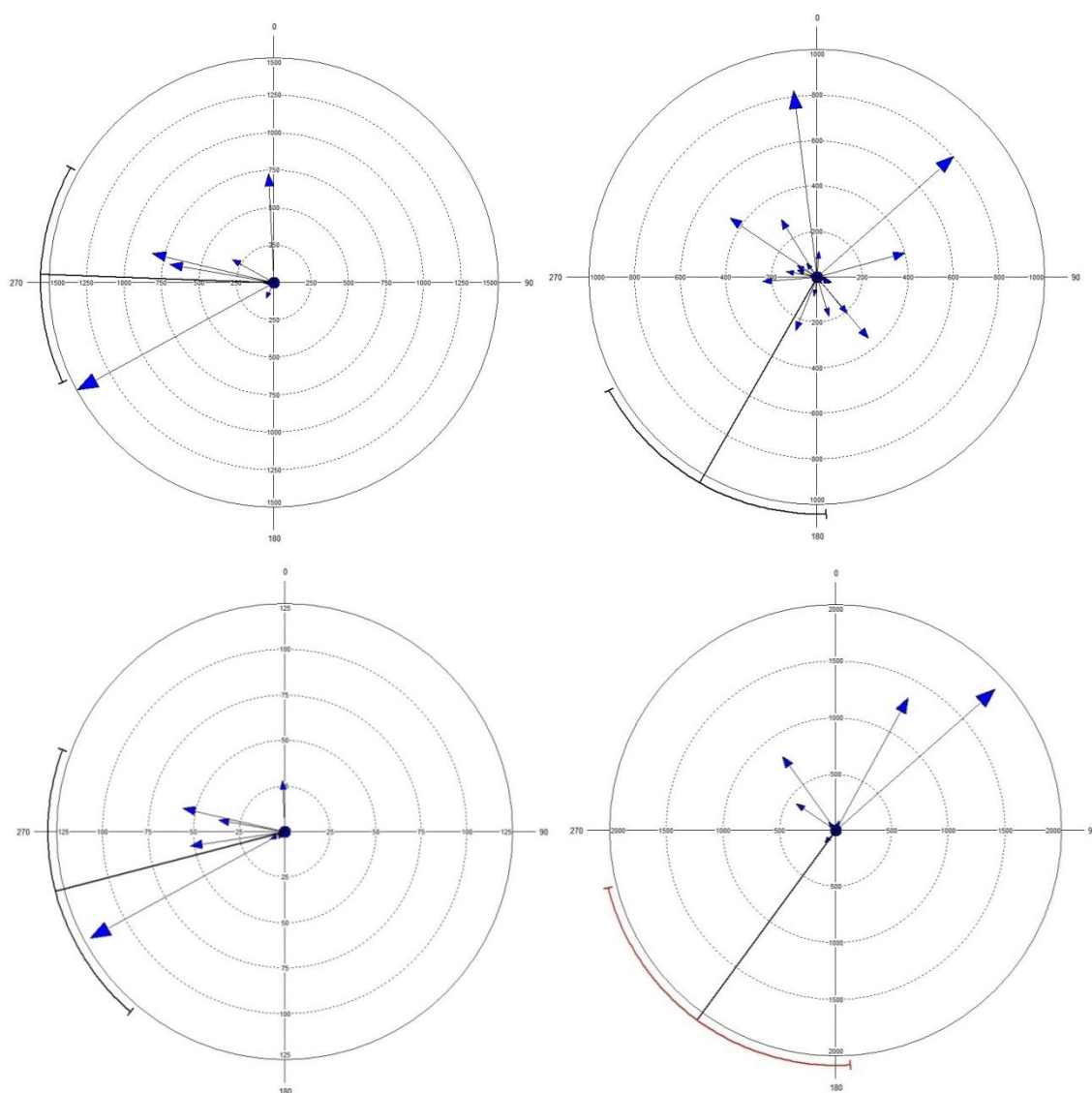

Figure 5.42 Relation between migration intensity of the Barnacle Goose in spring and autumn and wind direction, 2009-2010. For details see Figure 5.31.

Discussion

The Barnacle Goose represents a species, which is less dependent on landscape features (water, land) during migration. During spring, birds accumulate in the Wadden Sea and adjacent areas. They leave the Wadden Sea during favourable winds and migrate long distances without stop-over sites. Regarding food availability, Barnacle Geese utilise the Wadden Sea staging site and the Baltic stopover site at the moments of peak nutrient biomass. At the Russian breeding site, they arrive prior to the flush of spring growth of forage plants and profit from the peak in nutrient biomass when the goslings hatch and adult birds start moulting (van der Graaf et al., 2006). The biomass starts to grow in spring when the temperature increases to 6-7 degrees, which usually happens during large invasions of warm fronts from the south, i.e. not only wind but also other weather conditions may influence migration timing of this species.

However, the actual position of their migration route largely depends on actual wind conditions, which may cause a south- or northward shift of the migrating flocks. During autumn the highest numbers of Barnacle Geese were observed at Fehmarnbelt under weather conditions when migrants were forced somewhat to the south of their main migration route and this way appear in the Fehmarnbelt region.

During spring, when the Barnacle Goose migration is driven by a number of environmental factors (see above), the model shows low explanatory values. However, during autumn, the explanatory power is larger, suggesting, that autumn migration timing is more flexible and thus can be more adapted to favourable weather situations.

A substantial proportion of Barnacle Goose migrates also at night (Figure 5.41). The importance of the nocturnal phase of migration remains unclear, since our model only deals with the diurnal part of migration.

The majority of migrating Barnacle Geese will use migration routes which sometimes pass and sometimes do not pass the region of the Fehmarnbelt; the Danish part will be passed more frequently, but under specific weather conditions birds may also use a flight route across the planned fixed link.

5.3.3 Common Buzzard

The Common Buzzard presents a type 3 species, a landbird migrating during daytime. They are mostly short-distance migrants. Its breeding population in Sweden and Finland is some 41,000 pairs (Mebs and Schmidt 2006). These populations comprise mostly short distance migrants. Satellite telemetry shows that birds from Scandinavian populations in autumn migrate southwest and winter in Denmark, northern Germany, the Netherlands and Belgium. Autumn migration in average takes 19 days (ranging from 2 to 62 days) to cover the mean distance of some 700 km, the main migration direction is 207° ($r=0.992$) (Strandberg et al., 2009a). Common Buzzards from southern Sweden start autumn migration earlier and migrate shorter distances than birds from more northern parts of Sweden (Kjällén 1999). Ringing recoveries of Common Buzzards occur further south down to Northern Spain in comparison to recent satellite tracks (Figure 5.43). However, most of these southern recoveries were obtained several decades ago (Strandberg et al., 2009b). This mismatch could be explained by the fact that birds recovered more to the south were ringed north of the place of origin of satellite tagged birds. Also, effects of climate change may play a role.

FEHMARNBELT BIRDS

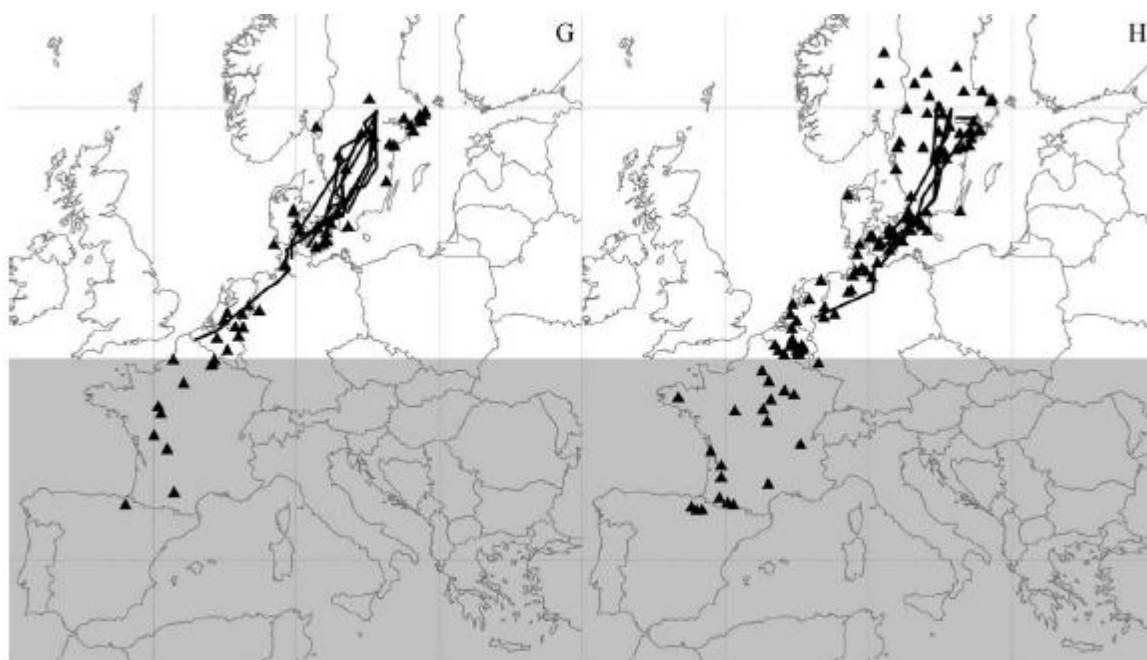

Figure 5.43 Comparison of wintering areas of Common Buzzard identified by satellite telemetry and ringing recoveries, G – adults, H – juveniles; shaded zone indicates the latitudes never reached by tracked birds (from Strandberg et al., 2009b with modifications).

Looking at the exact tracks of the satellite tagged birds, only 1 of 12 individuals crossed the area of Fehmarnbelt, while most individuals used different flyways or remained to winter on Danish islands north of Fehmarn (Figure 5.44). This coincides with the results of visual observations of 2009 on Falsterbo and at Rødbyhavn on Lolland. In Falsterbo the maximal count per day was about 2,500 birds, but on Lolland peak migration intensity was almost 30 birds per hour resulting in a day count of some 170 individuals, which would correspond to 1 of 14 individuals seen at Falsterbo passing Rødbyhavn (Figure 5.49).

Movements and short distance migration of Common Buzzards within the larger wintering area, including the Fehmarnbelt, depend on the weather and feeding conditions (Wuczyński 2003).

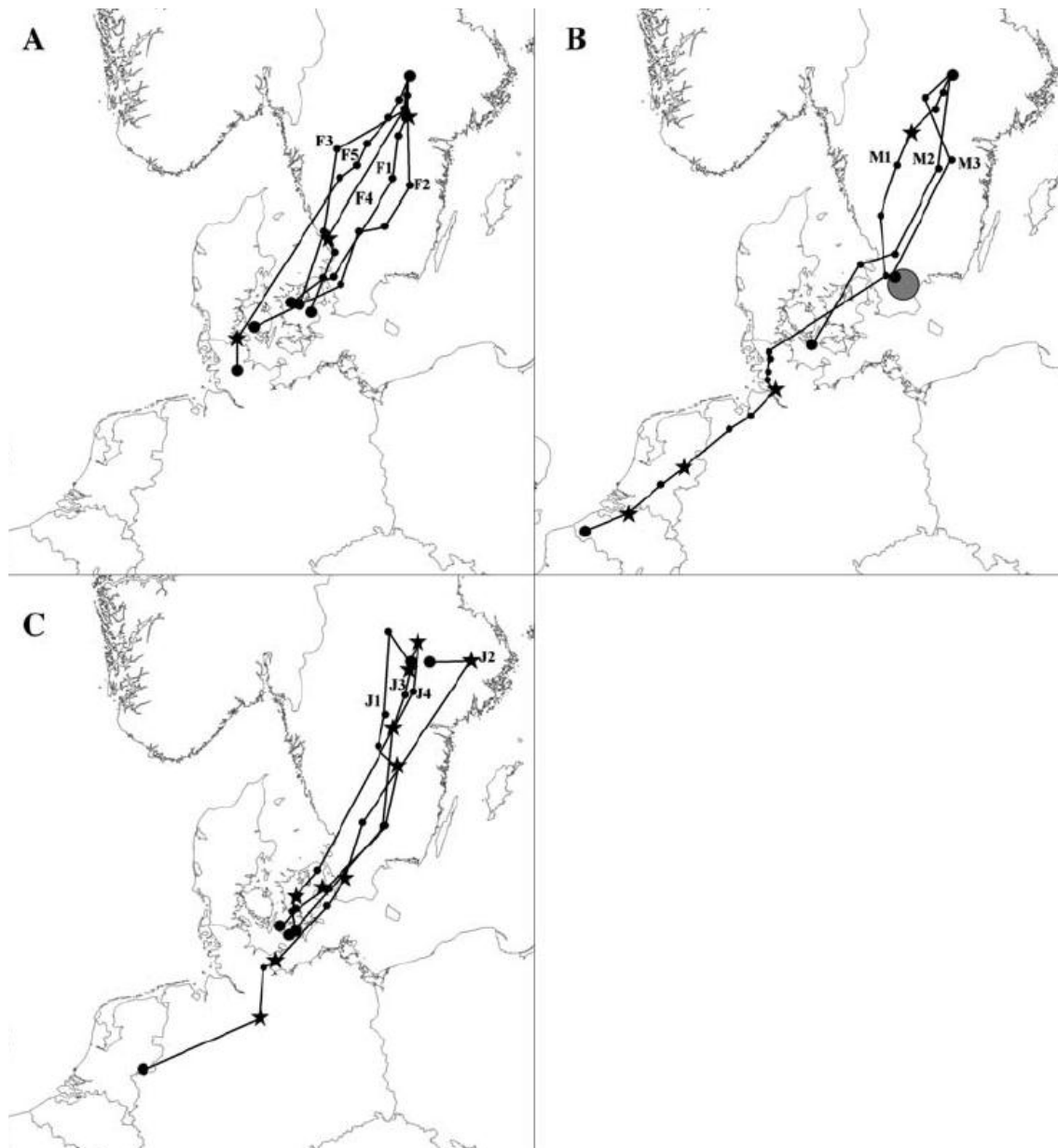

Figure 5.44 Autumn migration tracks for female (A), male (B) and juvenile (C) Common Buzzards, recorded by satellite telemetry tracking. Stars indicate stop-overs made along tracks [for juveniles (C) the dispersal areas are also indicated by the star symbol; first stop-over along track]. Black dots indicate wintering area (from Strandberg et al., 2009a).

Spring 2009

In spring 2009 several waves of migration were observed (Figure 5.45) and the three strongest migration peaks are shown in relation to seasonal dynamics of the five most important weather parameters (Figure 5.46). The highest migration peak occurred during March 16-18, when wind was strong (about 8 m/s) from NNW. This was the first well developed high pressure system for that spring. The nine top peaks of migration occurred with an average wind direction of 236°, i.e. SW ($p < 0.05$), while wind direction during the rest of the season was insignificant. However, the migration was weakest during southerly winds and strongest during westerly winds (Figure 5.40, Figure 5.48).

FEHMARNBELT BIRDS

The GAM model of spring migration of Common Buzzards at Fehmarn includes the four parameters Julian day, wind speed and direction and cloud altitude and explains 70 % of the variation of migration intensities (see Appendix A.9).

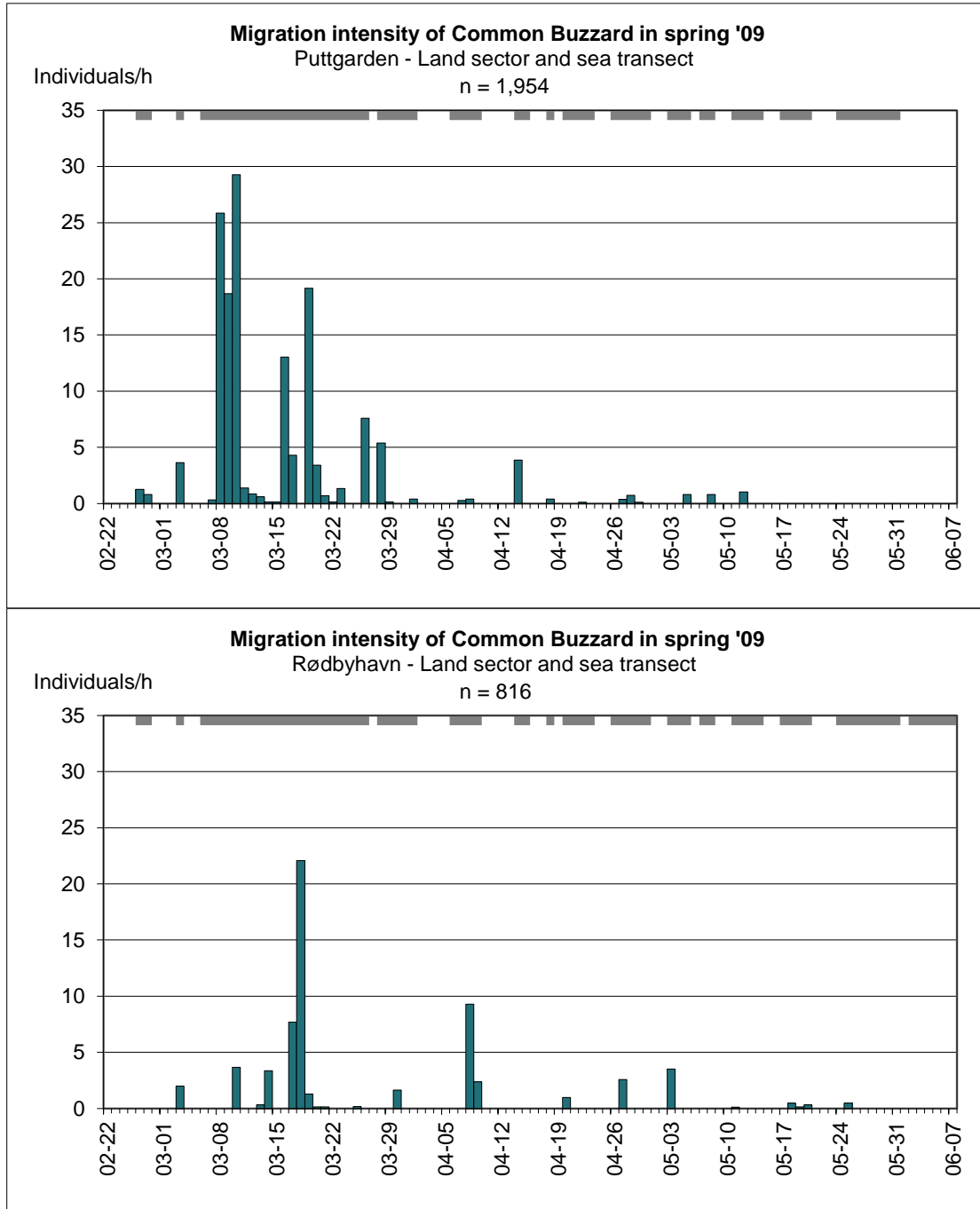

Figure 5.45 Dynamics of spring migration 2009 of Common Buzzard at Puttgarden (top) and Rødbyhavn (bottom). Days covered are indicated in grey on the upper axis.

FEHMARNBELT BIRDS

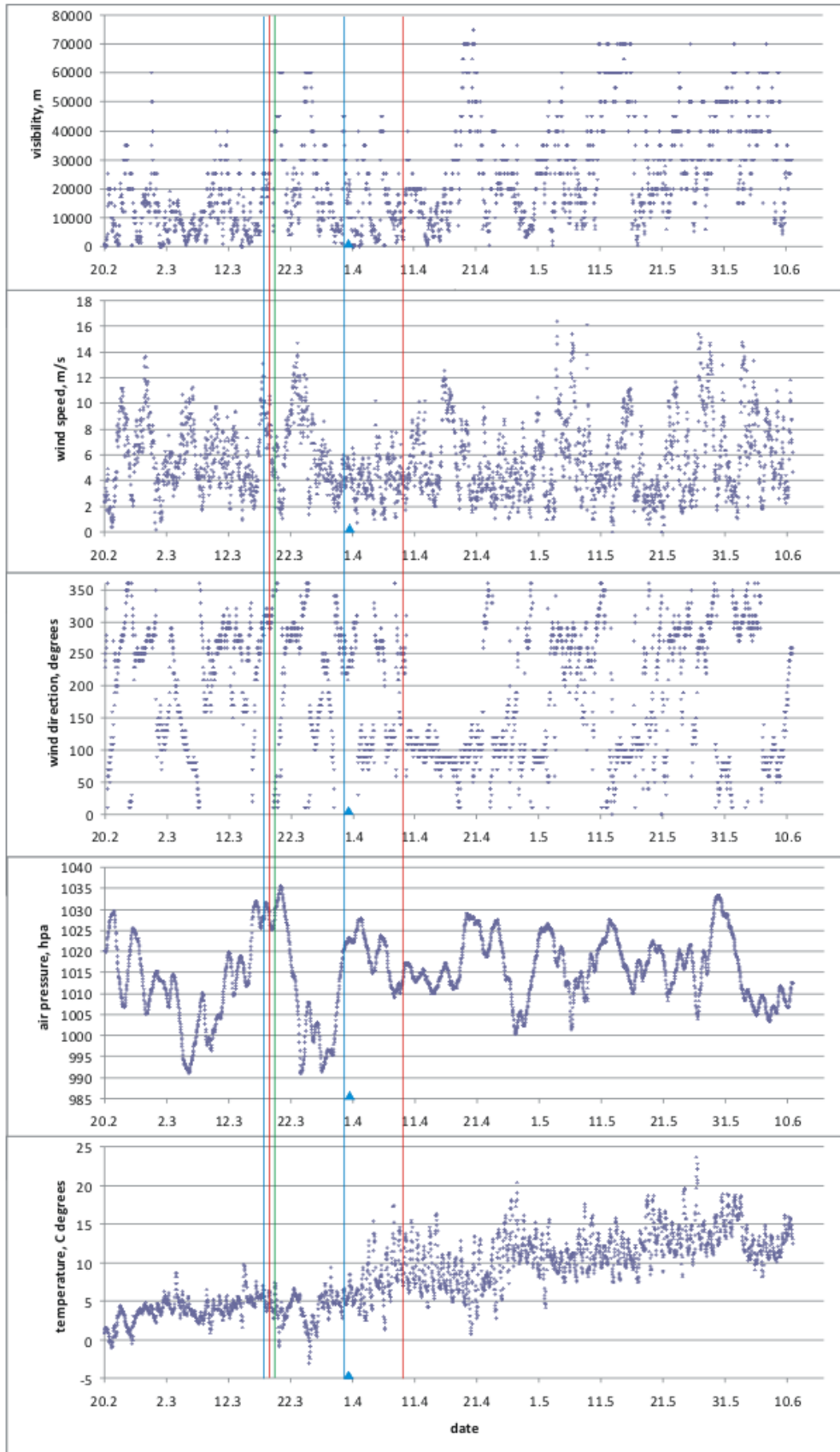

Figure 5.46 Occurrence of three strongest spring migration peaks of Common Buzzard at Puttgarden (blue lines), Rødbyhavn (red lines) in relation to weather parameters, or both Puttgarden and Rødbyhavn (green line). Blue triangle shows mean passage date on Fehmarn (OAG database).

FEHMARNBELT BIRDS

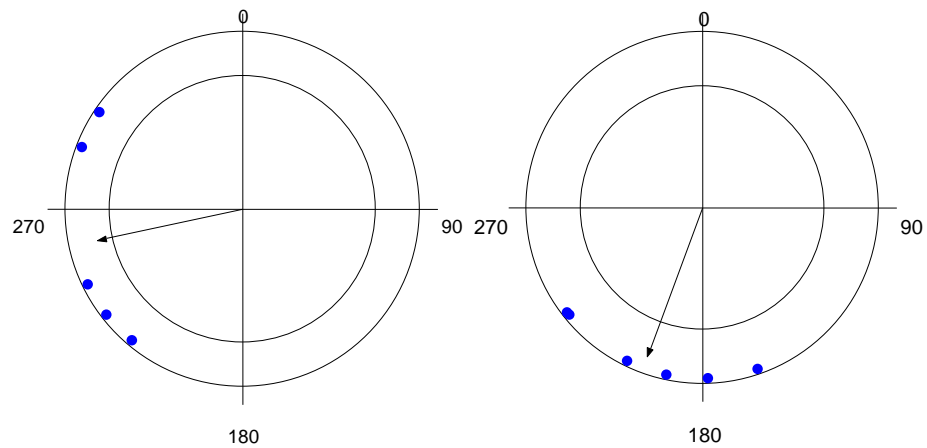

Figure 5.47 Wind direction during selected days (blue dots) and mean direction of wind (arrow) of Common Buzzard spring migration on Fehmarn for migration days when 90 % of birds passed the Fehmarnbelt. Left – peak migration days, right – days with weak migration. Further details see Figure 5.36.

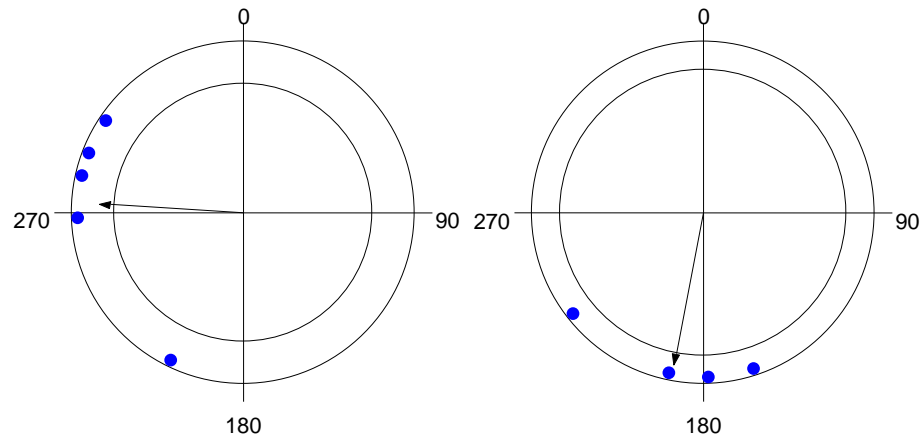

Figure 5.48 Wind direction during selected days (blue dots) and mean direction of wind (arrow) of Common Buzzard spring migration on Lolland during days when 90 % of birds passed the Fehmarnbelt. Left – peak migration days, right – days with weak migration. Further details see Figure 5.36.

Autumn 2009

In autumn 2009 more than a half of the Buzzards passed Fehmarnbelt within a period of six days around October 10, which coincides with the mean passage time for this species in the area (October 9 at Falsterbo) (Figure 5.49). The three largest peaks are shown in relation to seasonal dynamics of the five most important weather parameters (Figure 5.50). The strongest peak of migration occurred on October 12, three days after the peak at Falsterbo. The three strongest migration peaks were observed during days with north winds and a drop of temperature during 3-4 days prior to those peaks (Figure 5.50). Compared to spring, autumn migration occurred under a wider range of wind conditions. Only the four strongest peaks were observed during the days with northerly winds (Figure 5.51), while during the rest of the season when Buzzard migration was weak or absent wind was significantly more often coming from south (Figure 5.52).

The model of migration of Common Buzzards at Lolland includes three parameters, Julian day, wind speed / direction and visibility and explains 91 % of the variation.

FEHMARNBELT BIRDS

Due to this high explanatory power this model might be over-fitted (see Appendix A.9).

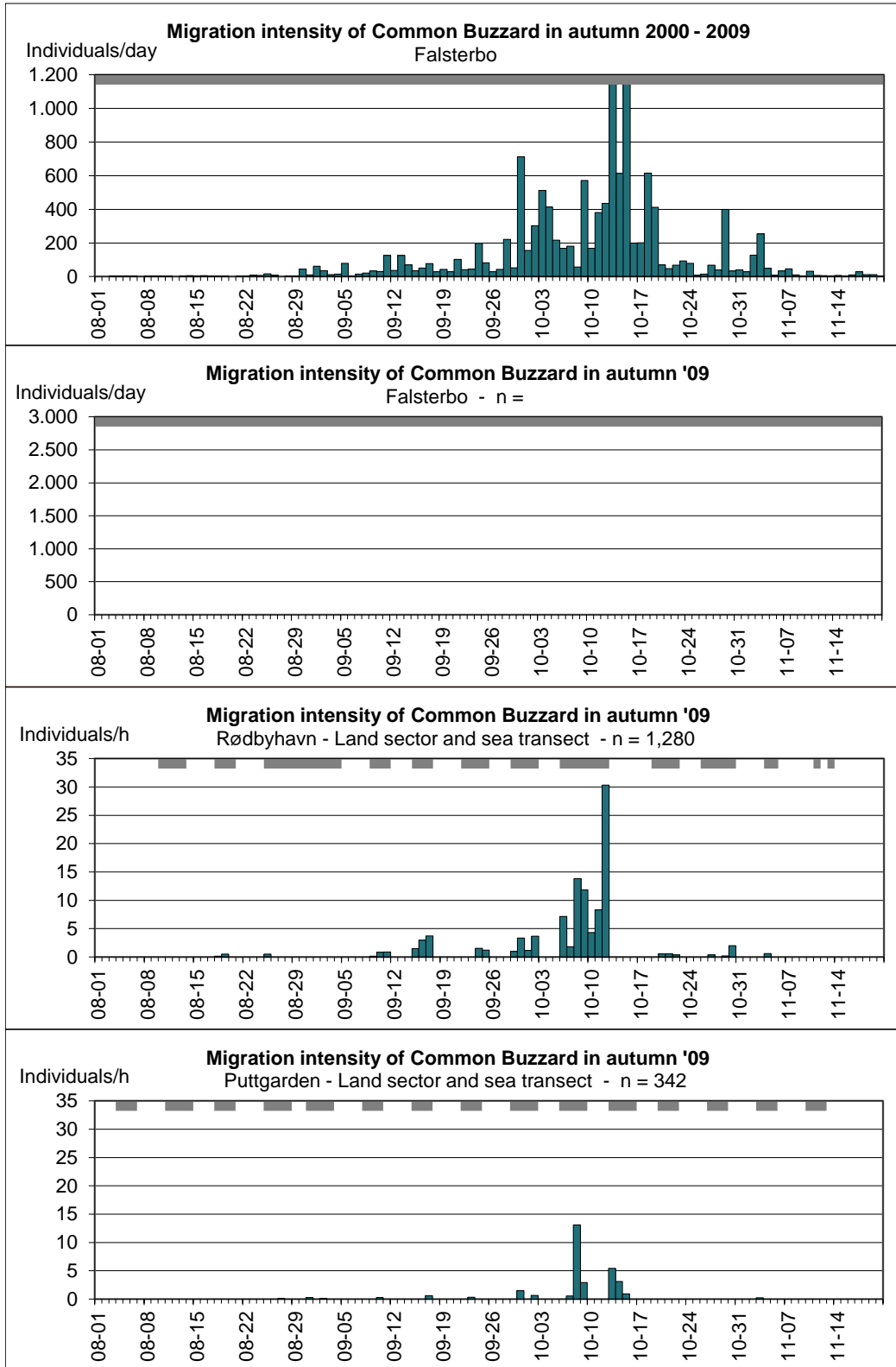

Figure 5.49 Dynamics of autumn migration 2009 of Common Buzzard at Falsterbo (average 2000-2009 and 2009; top), Puttgarden (middle) and Rødbyhavn (bottom). Days covered are indicated in grey on the upper axis.

FEHMARNBELT BIRDS

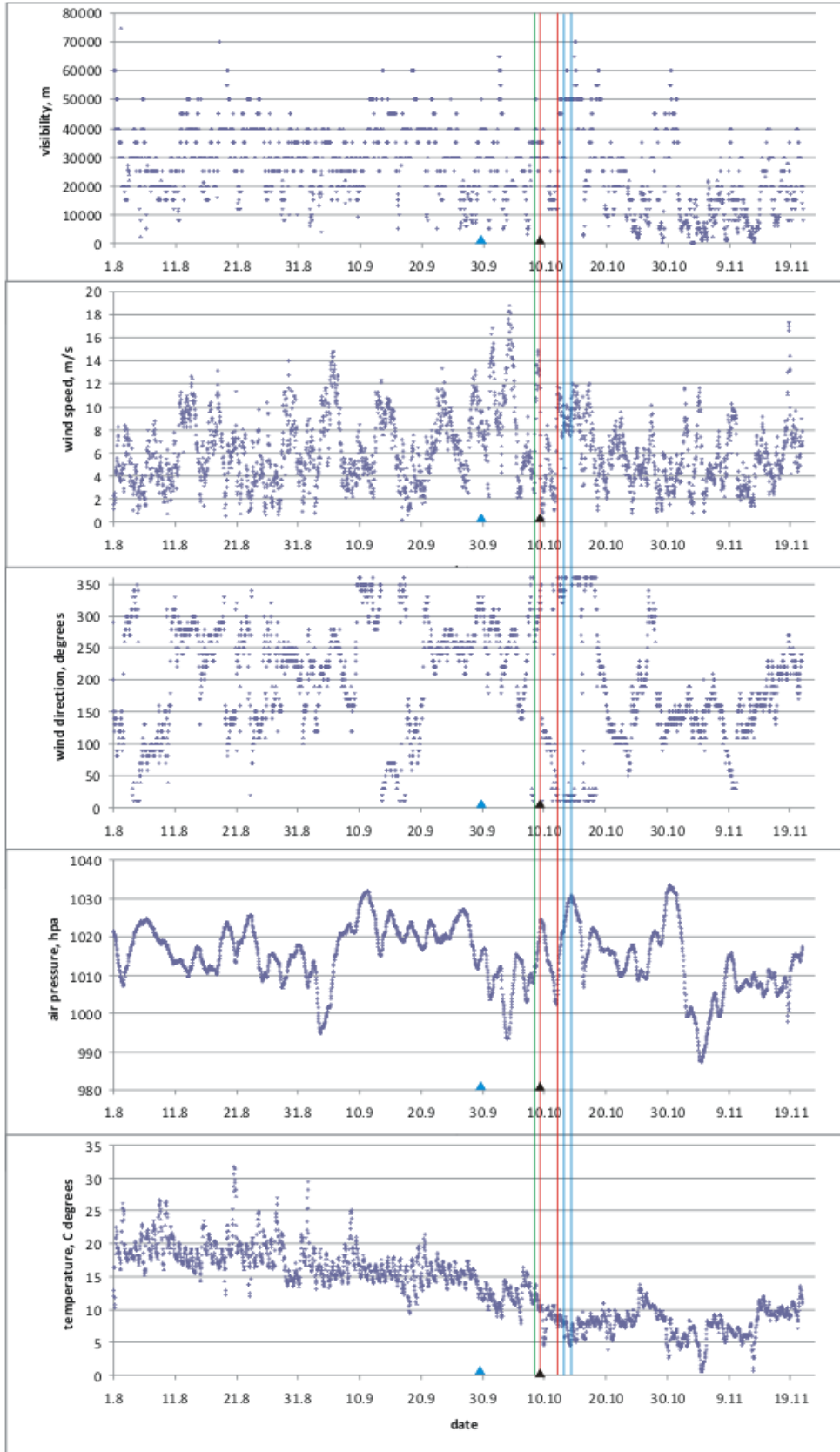

Figure 5.50 Occurrence of the three strongest autumn migration peaks of Common Buzzard at Puttgarden (blue lines), Rødbyhavn (red lines) in relation to weather parameters, or both Puttgarden and Rødbyhavn (green line). Blue triangle shows mean passage date on Fehmarn (OAG database), black triangle shows the 10 years-mean passage dates at Falsterbo.

FEHMARNBELT BIRDS

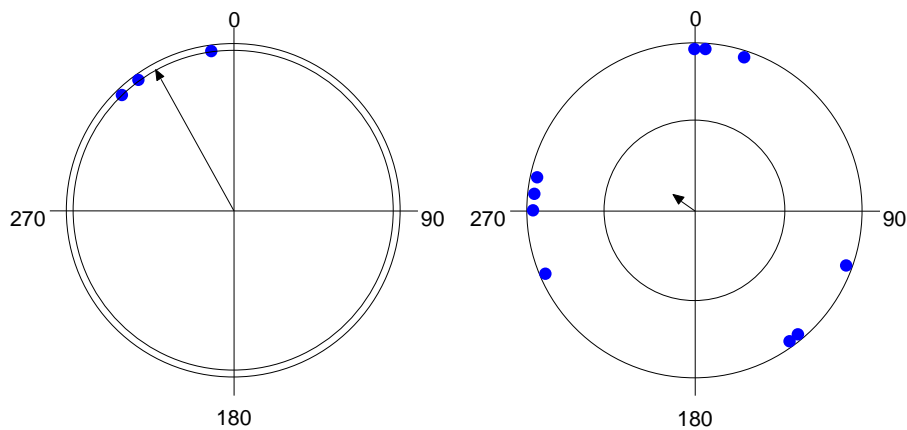

Figure 5.51 Wind direction during selected days (blue dots) and mean direction of wind (arrow) of Common Buzzard autumn migration on Fehmarn during days when 90 % of birds passed the Fehmarnbelt. Left – strongest peak migration days, right – days with weak migration. Further details see Figure 5.26.

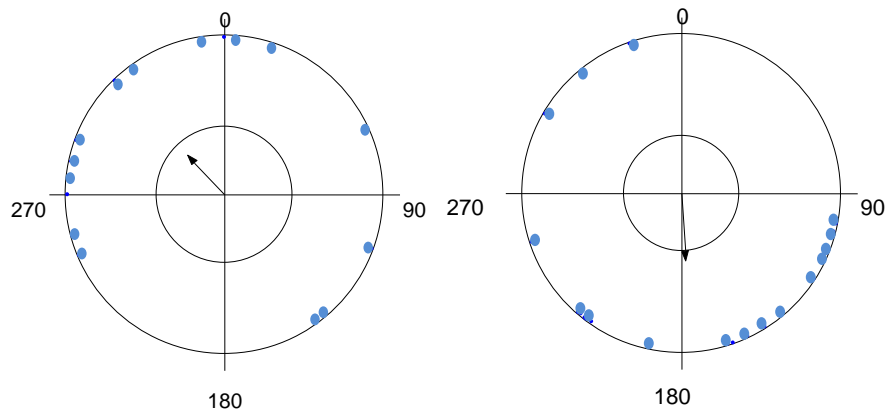

Figure 5.52 Wind direction during selected days (blue dots) and mean direction of wind (arrow) of Common Buzzard autumn migration on Lolland during the entire migratory season. Left – 16 peak migration days (mean wind direction is 317°, n.s.), right – days without migration (mean wind direction is 177°, $p=0.018$). Further details see Figure 5.26.

Results 2009/2010

During spring, the best model of migration of Common Buzzard at Fehmarn explained 58 % of the variation with parameters Julian day, wind direction (sin and cos), wind speed and cloud altitude. At Lolland the best model explained 41 % of the variation with the same set of parameters (see Appendix A.9). Results of the modelling of two years of observations confirm the importance of the cloud altitude for the migration behaviour of Common Buzzard found in 2009.

In autumn, the best model explains 53 % of the variation of migration at Fehmarn with parameters Julian day, wind direction (sin and cos), and wind speed included. At Lolland the best model explains 52 % of the variation with parameters Julian day, wind direction (sin and cos), wind speed and precipitation during morning (6-12 am) included (see Appendix A.9). At both places N-NE wind favour for the migration.

The relations between migration intensity and parameters included into the model such as wind direction, wind speed and cloud altitude at Fehmarn and Lolland are shown on Figure 5.26, Figure 5.54, Figure 5.53 and Figure 5.55, respectively.

FEHMARNBELT BIRDS

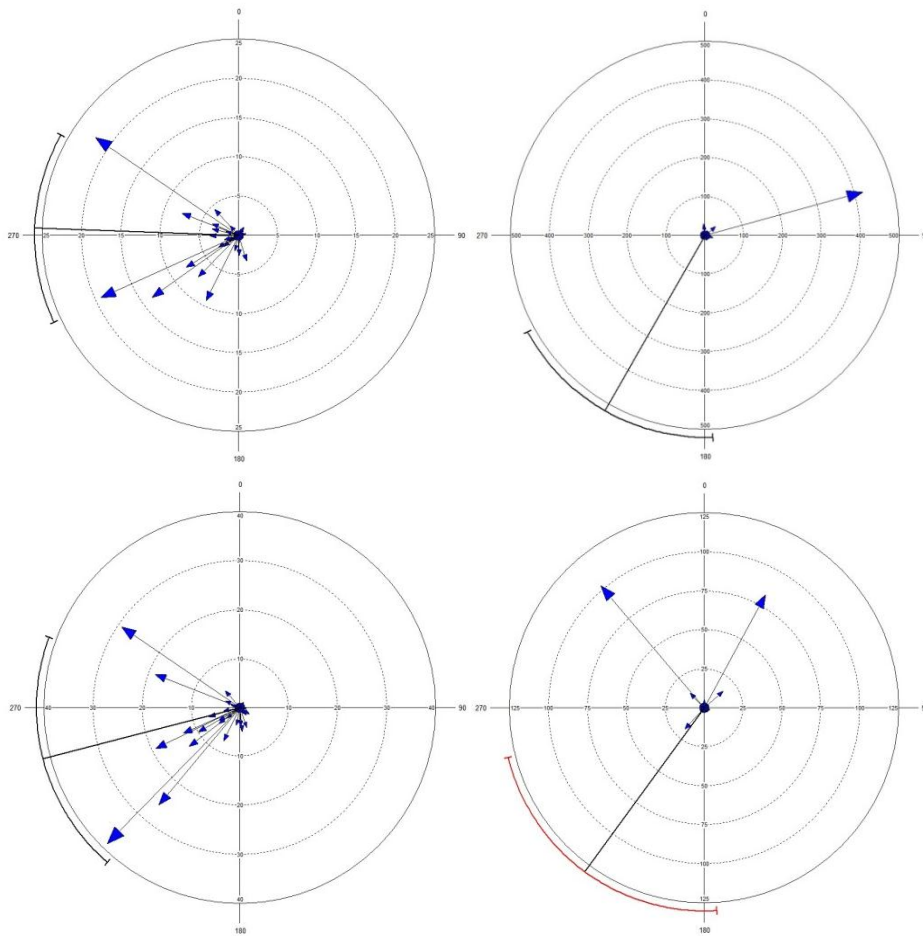

Figure 5.53 Relation between migration intensity of the Common Buzzard in spring and autumn and wind direction at Lolland (upper) and Fehmarn (lower) during spring (left) and autumn (right), 2009-2010. For details see Figure 5.31.

FEHMARNBELT BIRDS

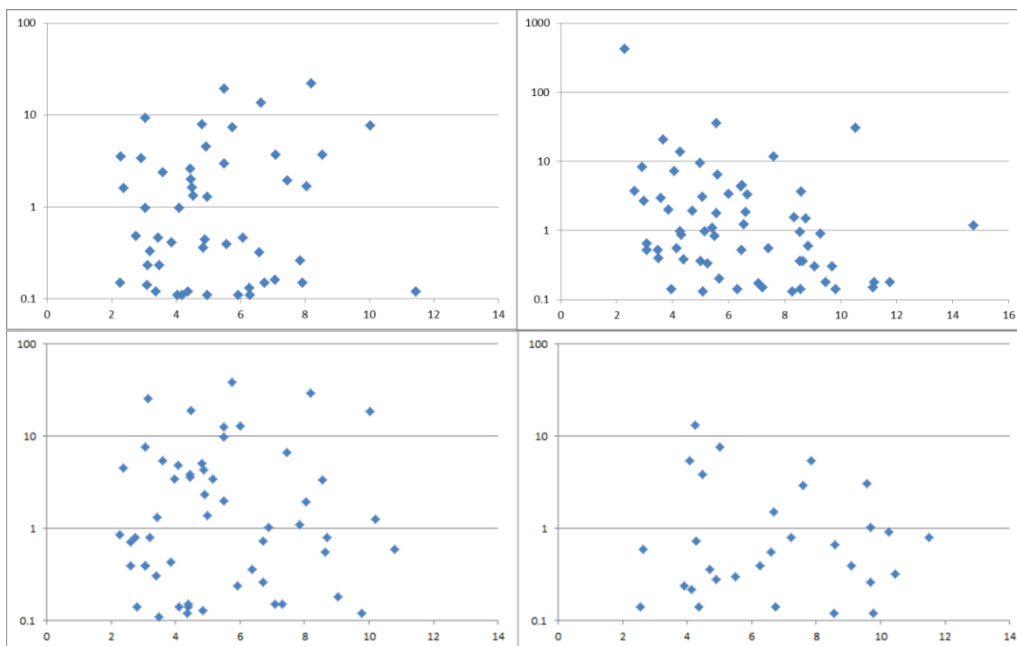

Figure 5.54 Relation between wind speed (horizontal axis [m/s]) and intensity of migration (vertical axis; lg of migration intensity in ind./h) of Common Buzzard in 2009–2010 at Lolland (upper) and Fehmarn (lower) during spring (left) and autumn (right).

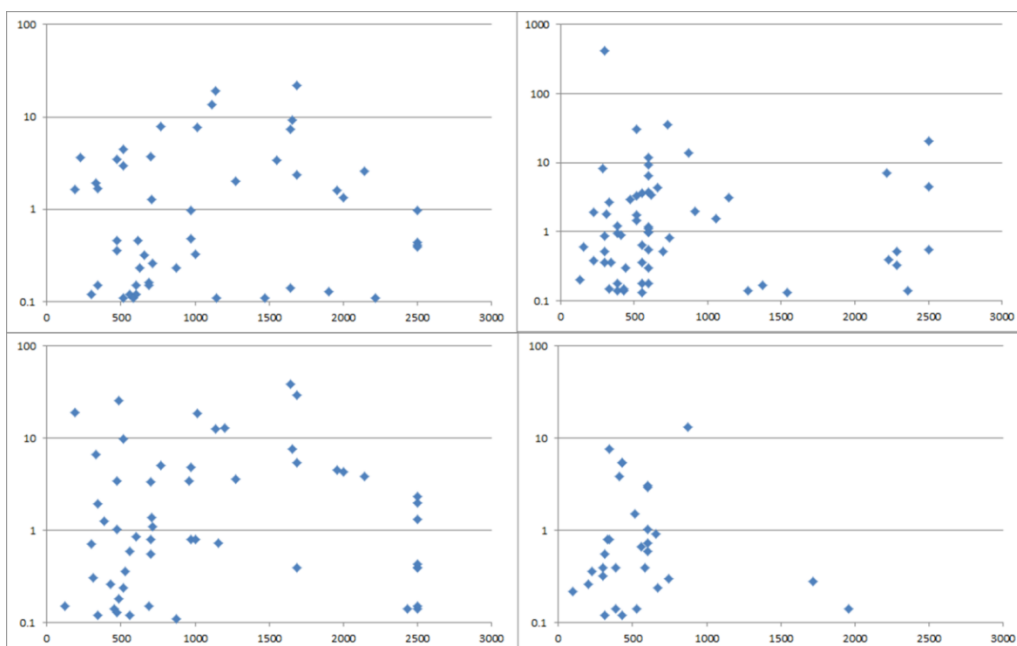

Figure 5.55 Relation between cloud altitude (horizontal axis, [m]) and intensity of migration (vertical axis; lg of migration intensity in ind./h) of Common Buzzard in 2009–2010 at Lolland (upper) and Fehmarn (lower) during spring (left) and autumn (right).

Discussion

Common Buzzards are short distance migrants and both their migration routes and their wintering area overlap with the Fehmarnbelt region. As daytime migrants they can be easily registered in the field and numbers at all stations do well reflect both migration and short distance movements. Migration phenology and numbers in

2009 and 2010 do match well with results from other sources (Falsterbo, DOF, OAG). However, observations of 2009 and 2010 represent a spotlight on this species' options to migrate in the region depending on local and regional weather conditions as well as population parameters like e.g. breeding success and food availability. Thus, Common Buzzards show a flexible schedule with regard to migration phenology and clearly have a species specific migration period, which is also suggested by the importance of the parameter "Julian day" in the model. Pronounced migration peaks were observed in both seasons. Thus, both spring and autumn migration of Common Buzzards is found to be strongly influenced by weather conditions, of which the most important one is the wind direction. Buzzards tend to migrate during tailwind conditions, but when this is impossible they at least select days without headwind. Common Buzzards regularly soar during migration using updrafts. Cloud altitude is also found to be an important parameter for the spring migration of Common Buzzard probably because it is connected with the development of the specific atmospheric conditions needed for soaring.

5.3.4 Honey Buzzard

Honey Buzzard is another type 3 species. However, opposed to the Common Buzzard it represents a long-distance migrant species with individuals migrating from as far north as Norway and Finland all the way to central and South Africa (Figure 5.56). Its migration behaviour is well described, with most birds migrating across the Strait of Gibraltar (Hake et al., 2003, Thorup et al., 2003).

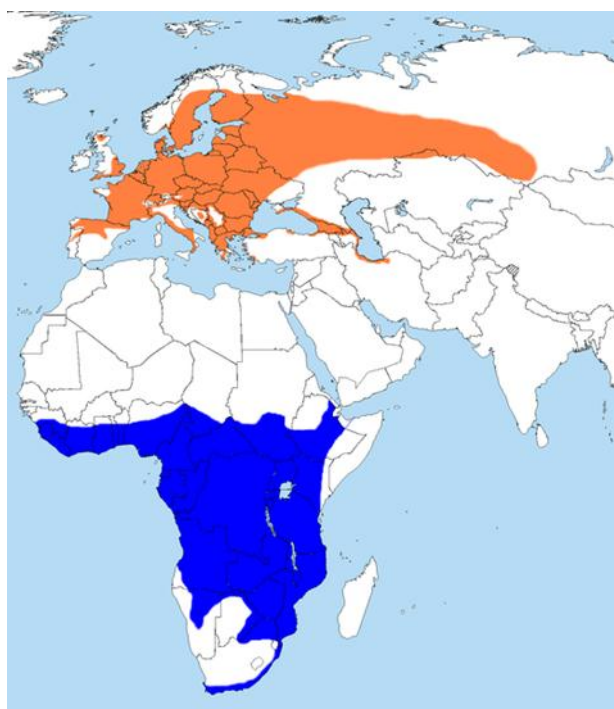

Figure 5.56 Breeding (orange) and wintering (blue) areas of Honey Buzzard (Mebs and Schmidt 2006).

Honey Buzzards have a tight migration schedule. Thus, the Baltic Sea is crossed generally during a short period in late August / early September. Even though this species will prefer tailwind situations, it will be forced to also migrate in headwind situations if their "migration window" expires. The dynamics of migration of Honey Buzzard in 2009 are shown on the Figure 5.59 and Figure 5.60.

FEHMARNBELT BIRDS

Spring 2009

The spring migration of Honey Buzzard in 2009 depended on the wind direction (Figure 5.57). At Fehmarn the mean direction of wind during four days with migration intensity > 1 bird/hour was 205° (Rayleigh test, $n=4$, $p=0.035$). During the 12 days with no or weak migration the mean wind direction was 345° (ns, Rayleigh test, $n=12$, $p=0.495$). At Lolland the mean direction of wind during four days with migration intensity > 1 bird/hour was 214° (ns, Rayleigh test, $n=5$, $p=0.159$). During the 17 days with no or weak migration the mean wind direction was 4° (ns, Rayleigh test, $n=17$, $p=0.312$). However, the largest peak of migration at Lolland occurred at the same day as at Fehmarn also with tailwind.

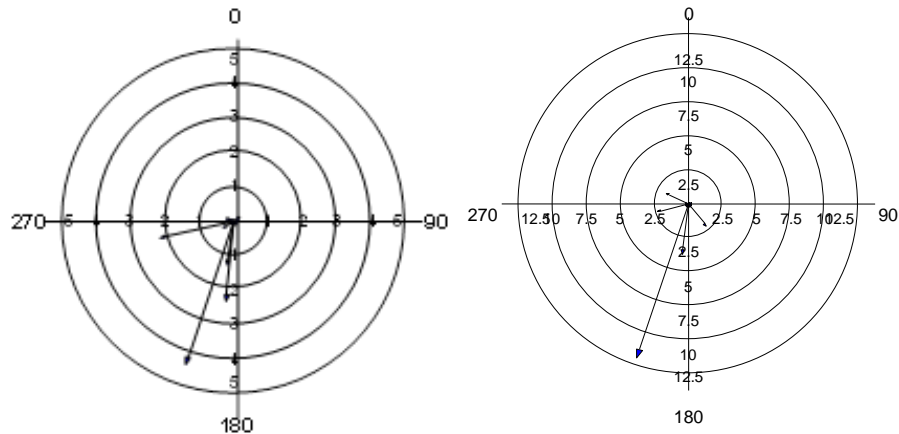

Figure 5.57 Intensity of spring migration of Honey Buzzard in relation to wind direction (left – Fehmarn, right – Lolland). For details see Figure 5.28 and text above.

In spring the migration model on Fehmarn includes three parameters, Julian day, wind projections and cloud altitude, and explains 76 % of the variation (see Appendix A.9).

Autumn 2009

In autumn, during the short migratory period of Honey Buzzard, southerly winds were dominating (Figure 5.58, Figure 5.61). Despite of the opposing winds, birds were migrating. Satellite telemetry shows that the mean direction of autumn migration of Honey Buzzards is 193° (Hake et al., 2003). The baseline data suggest that Honey Buzzards were trying to avoid headwinds, since the largest peaks of migration occurred under westerly winds, but birds were also migrating against most unfavourable winds (Figure 5.58). Under such adverse conditions Honey Buzzards crossed the Fehmarnbelt flying very low sometimes directly over the waves.

In autumn the best model of migration on Lolland includes three parameters (Julian day, wind projections and temperature trend) and explains 46 % of the variation (see Appendix A.9).

FEHMARNBELT BIRDS

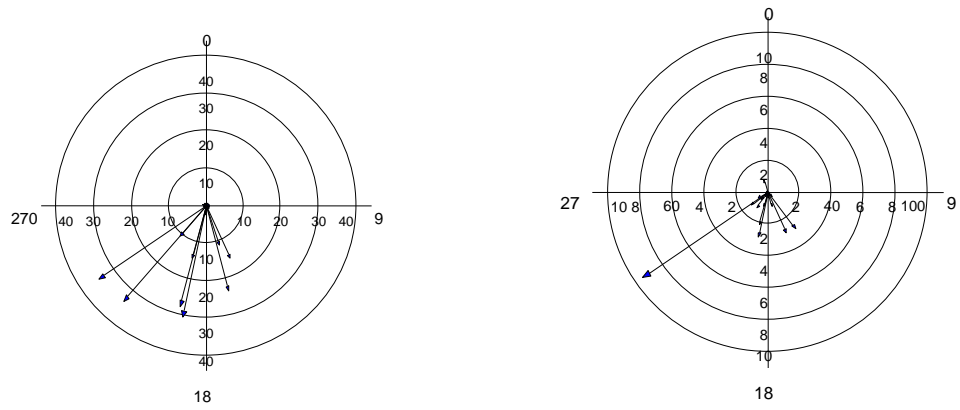

Figure 5.58 Intensity of autumn migration of Honey Buzzard in relation to wind direction (left – Fehmarn, right – Lolland). For details see Figure 5.28.

FEHMARNBELT BIRDS

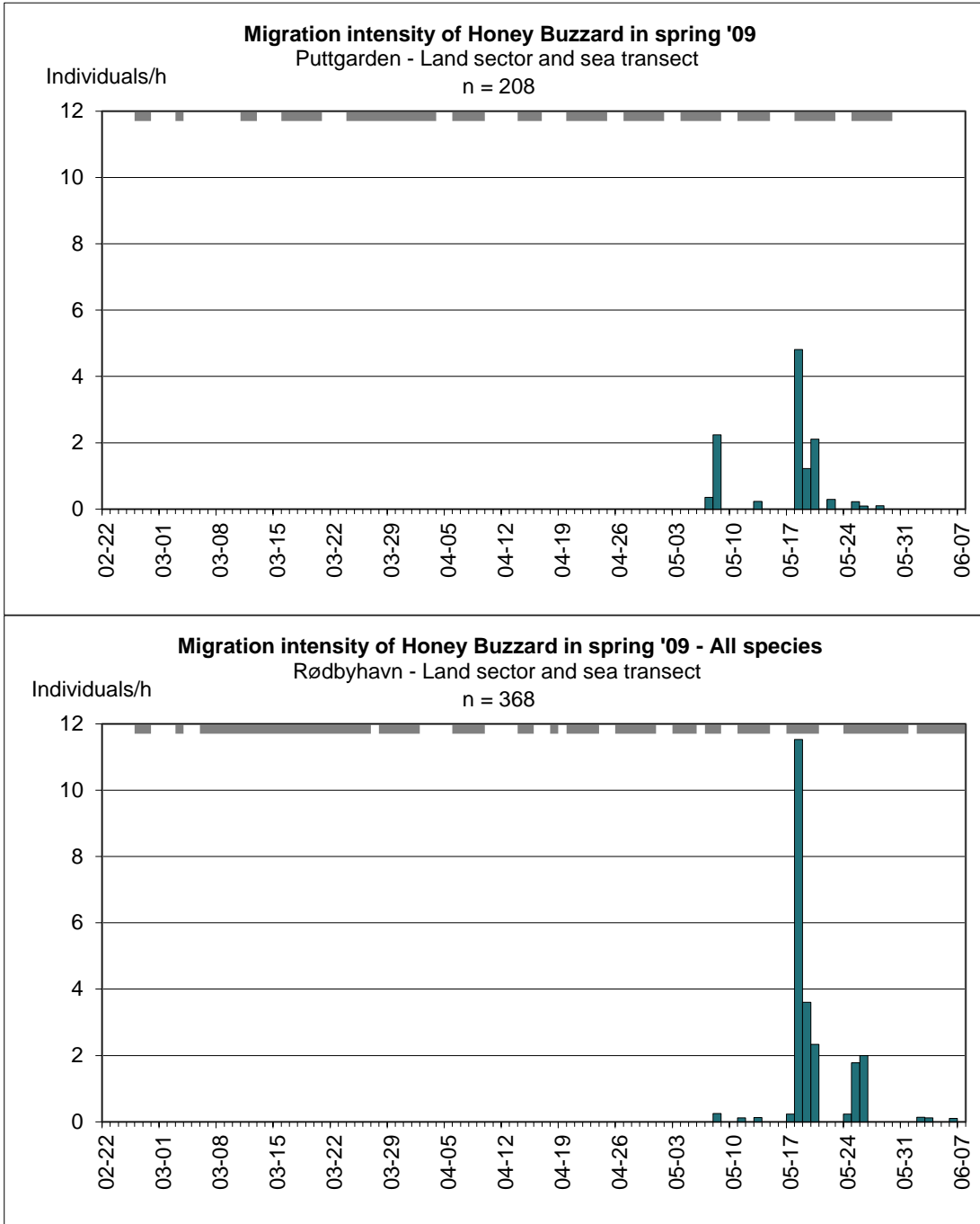

Figure 5.59 Dynamics of spring migration of Honey Buzzard at Puttgarden (top) and Rødbyhavn (bottom). Days covered with observations are indicated in grey on the upper axis.

FEHMARNBELT BIRDS

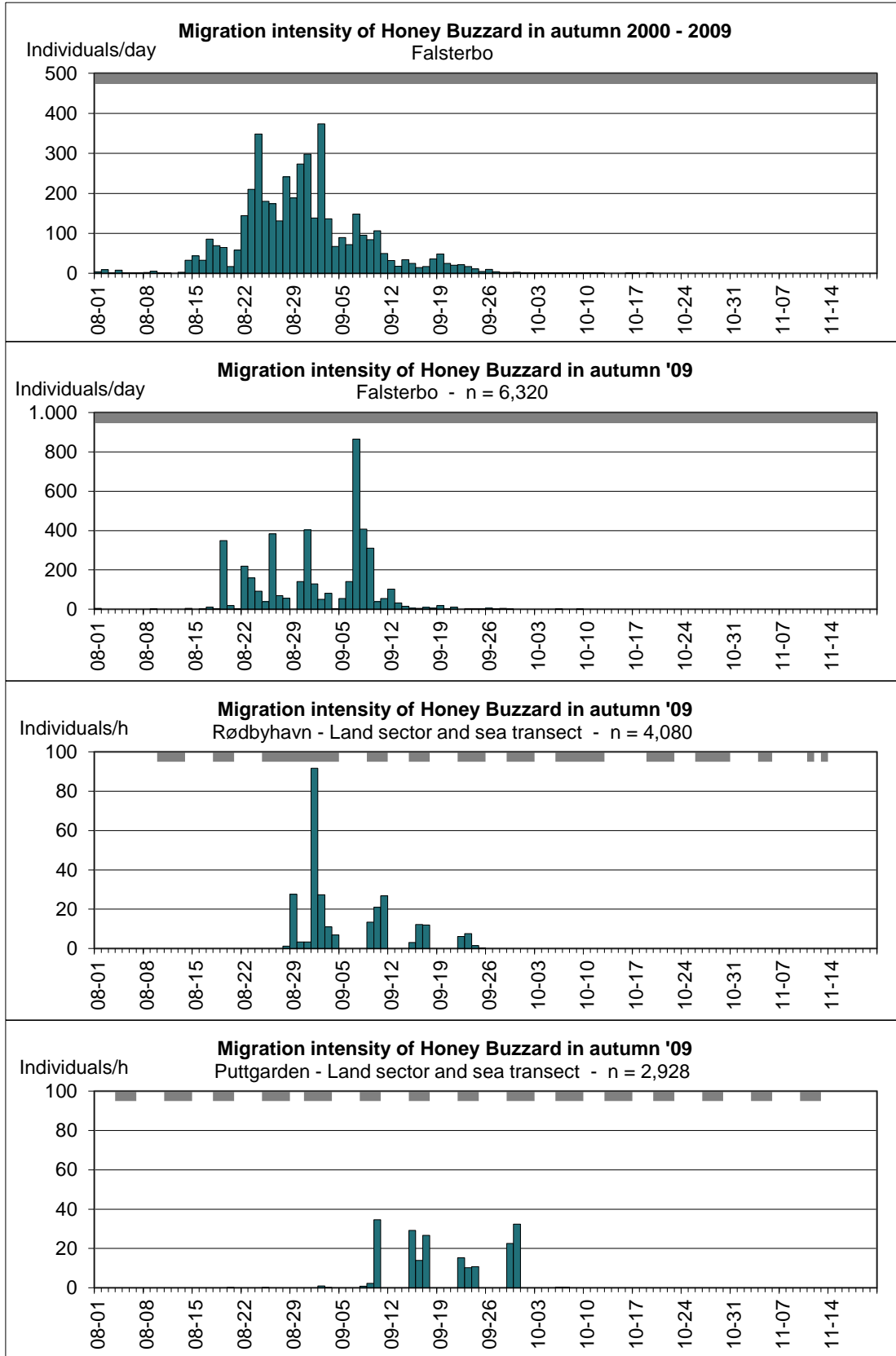

Figure 5.60 Dynamics of autumn migration of Honey Buzzard at Falsterbo (average 2000-2009 and 2009; top), Puttgarden (middle) and Rødbyhavn (bottom). Days covered are indicated in grey on the upper axis.

FEHMARNBELT BIRDS

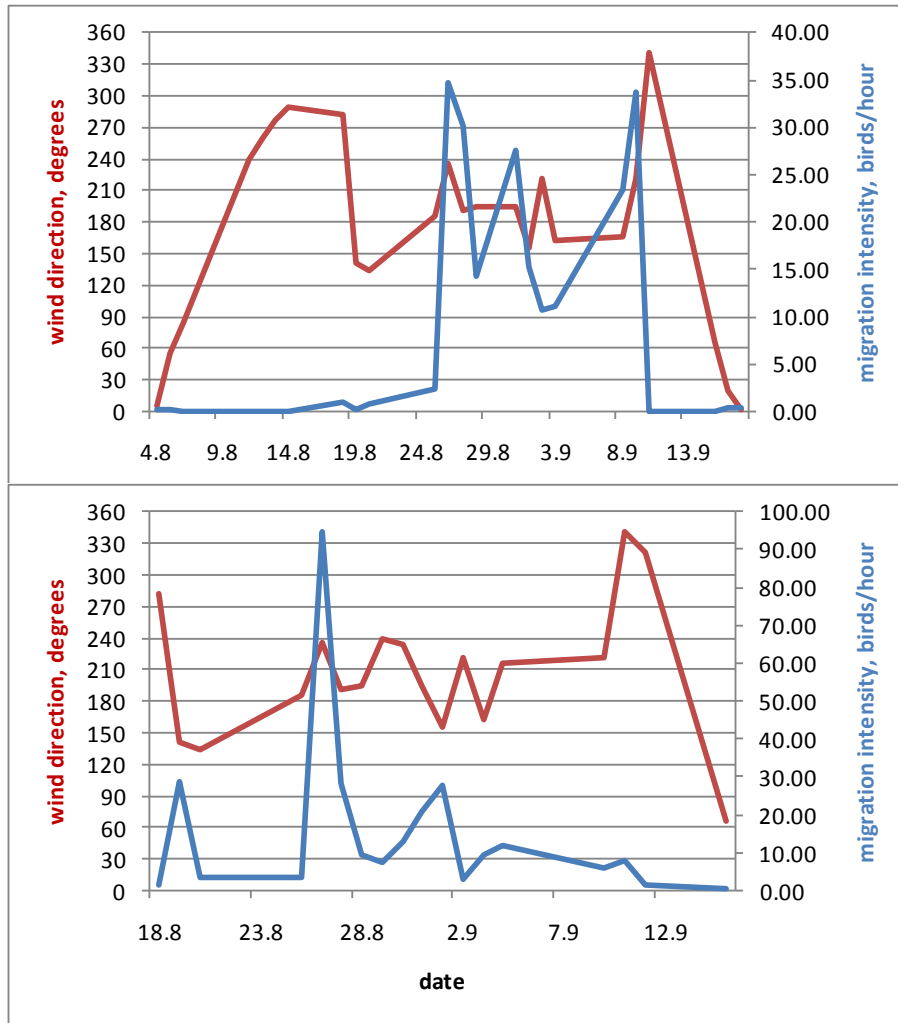

Figure 5.61 Dynamics of autumn migration of Honey Buzzard (migration intensity in blue, right y-axis) in relation to wind direction (in red, left y-axis). Top: Fehmarn; bottom: Lolland.

Results 2009/2010

In spring seasons, the best model explained 31 % of the variation of migration of Honey Buzzard at Fehmarn with the parameters Julian day, projections of wind vector and visibility. At Lolland the model explained 33 % of the variation with the parameters Julian day, wind direction (sin and cos), wind speed and temperature trend during the previous 2 days (see Appendix A.9). SE winds favour spring migration.

In autumn, the best model explained 33 % of the variation at Lolland with the parameters Julian day, wind direction (sin and cos) and wind speed. At Puttgarden the best model explained 58 % of the variation with the parameters Julian day, projection of the wind vector and visibility (see Appendix A.9).

Relations between migration intensity and weather parameters selected for the model such as wind direction, wind speed, visibility and temperature trend in previous 2 days are shown on Figure 5.62 to Figure 5.65, respectively. Julian day, wind direction and wind speed are three of the most important parameters explaining the migration. The other parameters are specific for each location and have less explanatory power.

FEHMARNBELT BIRDS

In contrast to the Common Buzzard, the explanatory power of the model of Honey Buzzard migration based on the weather parameters is low, most likely because of the migratory behaviour of this species. As a long-distance trans-equatorial migrant endogenous programme may play a major role in the regulation of its migration.

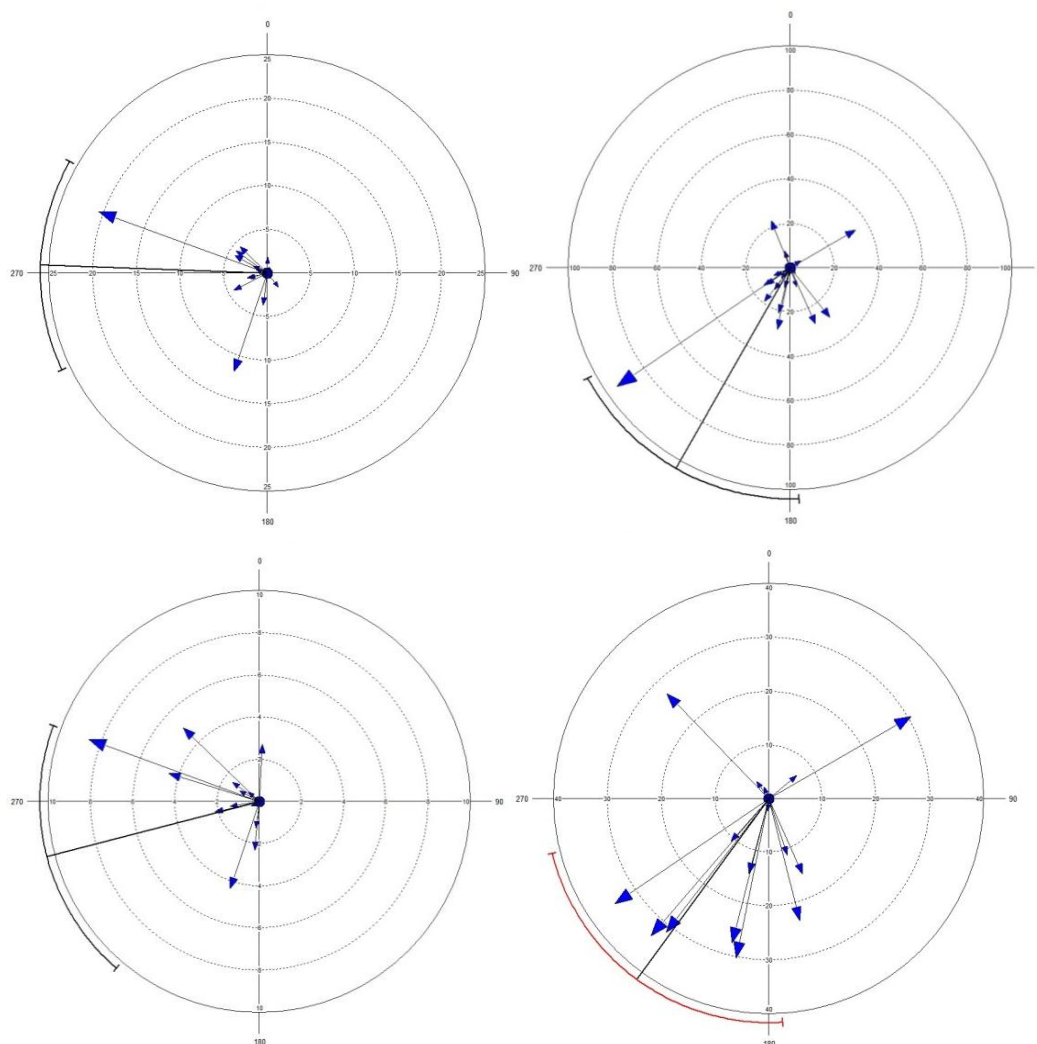

Figure 5.62 Relation between migration intensity of the Honey Buzzard in spring and autumn and wind direction, 2009-2010. For details see Figure 5.31.

FEHMARNBELT BIRDS

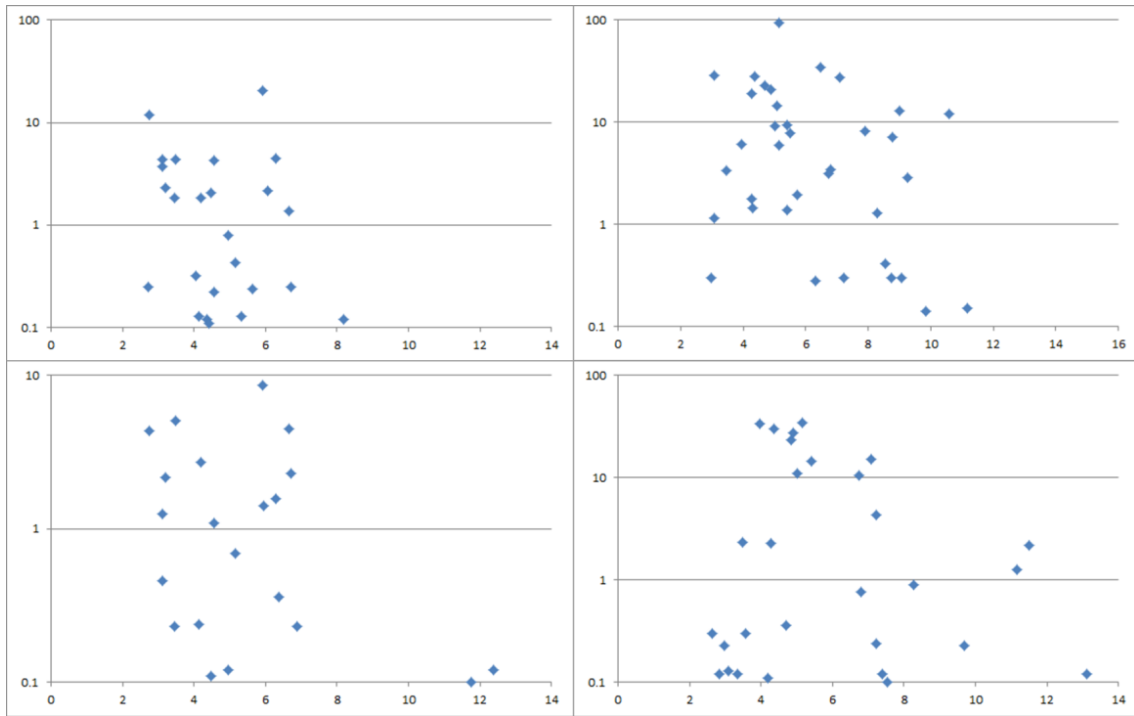

Figure 5.63 Relation between wind speed (horizontal axis [m/s]) and intensity of migration (vertical axis; lg of migration intensity in ind./h) of Honey Buzzard in 2009–2010 at Lolland (upper) and Fehmarn (lower) during spring (left) and autumn (right).

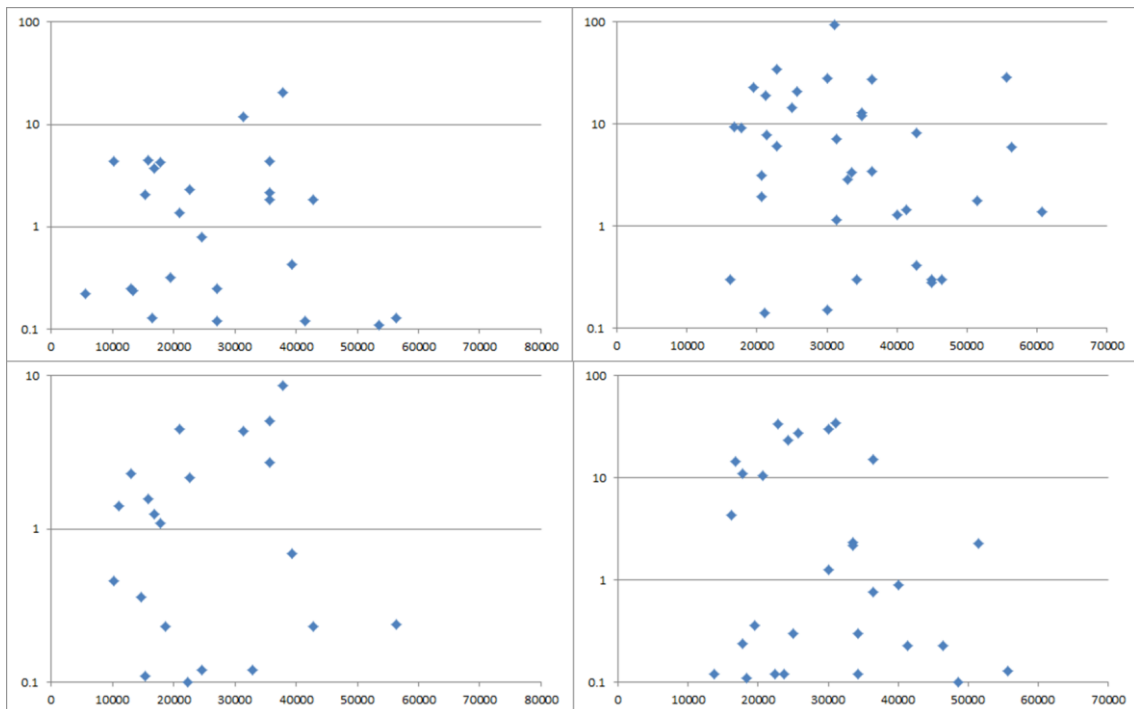

Figure 5.64 Relation between visibility (horizontal axis [m]) and intensity of migration (vertical axis; lg of migration intensity in ind./h) of Honey Buzzard in 2009–2010 at Lolland (upper) and Fehmarn (lower) during spring (left) and autumn (right).

FEHMARNBELT BIRDS

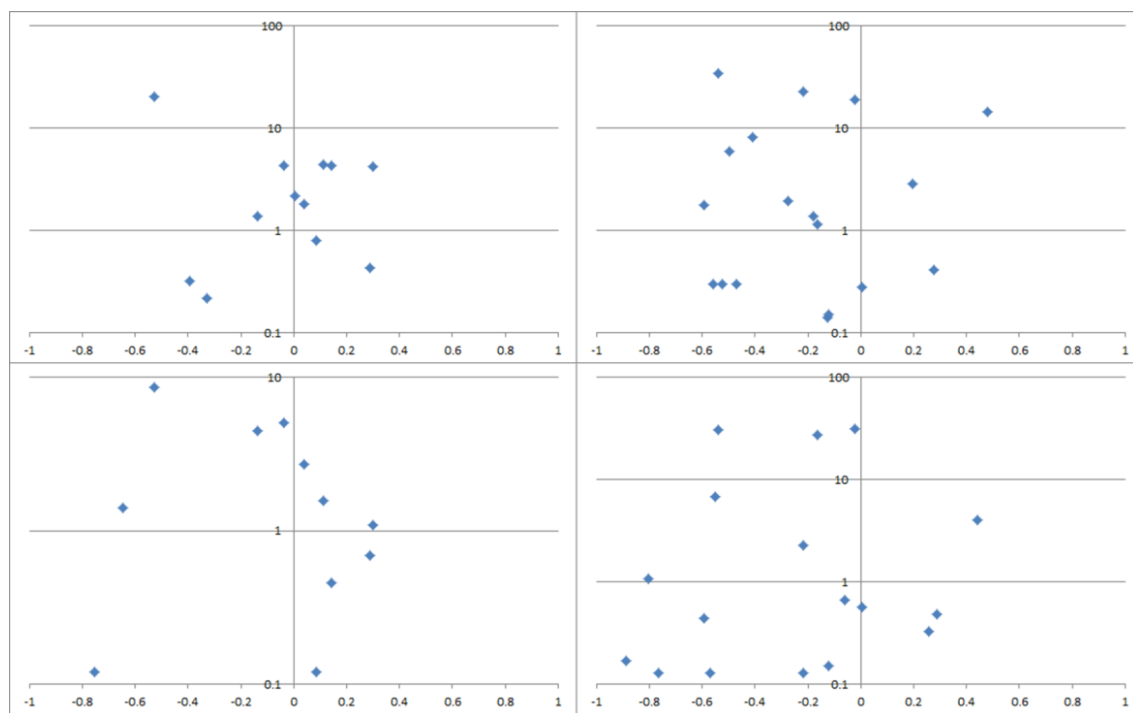

Figure 5.65 Relation between temperature trend in previous 2 days (horizontal axis [degrees]) and intensity of migration (vertical axis; lg of migration intensity in ind./h) of Honey Buzzard in 2009–2010 at Lolland (upper) and Fehmarn (lower) during spring (left) and autumn (right).

Discussion

For Honey Buzzard, a wealth of data exists for its migration behaviour and strategies. Most interesting, Shamoun-Baranes et al. (2006) presented a model of the relationship between weather conditions at the breeding areas and arrival of soaring birds (first bird arrival and mean date) to intermediate staging areas in Israel during autumn migration. Honey Buzzard arrival dates are positively related to sea level pressure (SLP - actual air pressure adapted to sea level), i.e. the higher the mean sea level pressure at the breeding site (Eastern Baltic), the later do Honey Buzzards arrive in Israel. Honey Buzzards have a period of meteorological sensitivity from the last week of July to the first week of August. The higher the number of days when sea level pressures are below 1014 hPa during these 15 days of meteorological sensitivity, the earlier Honey Buzzards arrive in Israel. In turn, the lower the number of days with sea level pressures above 1014 hPa, the later the birds arrive in Israel.

The Scandinavian populations of Honey Buzzards crossing Fehmarnbelt area migrate to West Africa via Gibraltar. However, it seems reasonable to extrapolate the results from the eastern migratory route to the western route and compare weather conditions and phenology. According to the baseline data and long-term visual observations at Falsterbo, mass autumn migration of Honey Buzzards begins around August 15 with very few birds migrating during the first half of August. The models of migration and weather of Honey Buzzards in the Fehmarnbelt region demonstrate that birds benefit from the wind direction. Low air pressure is usually associated with the passage of a cyclone, which in turn generates wind that might assist Honey Buzzard migration and speed up the arrival of birds to their wintering grounds. In turn, high air pressure is usually associated with anticyclones with low mobility of air masses, which may explain the negative effect of high pressure systems on the arrival of Honey Buzzards to wintering grounds (see above). Usually, the arrival dates of the first birds is the best measure with regard to the influence of weather parameters on migration, whereas mean dates of arrival are

influenced by a more complex system of parameters, and also may contain methodological biases of regular visual observations. Thus, the earliest individuals leaving their breeding grounds end of July - beginning of August may be especially subject to weather-driven migration as long as they start migration with a relatively low time pressure to be able to choose favourable weather conditions.

5.3.5 *Tree Pipit*

The Tree Pipit is also a representative of a type 3 species, and it is a long distance trans-Saharan migrant wintering in Sahel and Eastern Africa (Figure 5.66). While Tree Pipit is mostly a diurnal migrant, under particular conditions of time deficit it also migrates during night (Jenni 1984), when only nocturnal acoustic observations can be used to analyse migration intensities.

The timing of spring migration of Tree Pipit across the Baltic Sea largely depends on the weather conditions on the route of migration. Long term datasets of arrival dates and statistics on passage time at the island of Christians Ø (Western Baltic) suggests earlier arrival of Tree Pipit during the last decades (Tøttrup et al., 2006). The earlier arrival of this species to Europe was not correlated with the NAO (Northern Atlantic Oscillations) index which reflects the winter and early spring conditions in Europe (Hubalek 2003), but rather depended on the weather conditions at the wintering grounds in Africa or during initial stages of spring migration (Saino et al., 2007). These findings predict that timing of spring migration is influenced at the early stages before birds appear in Europe.

Autumn migration of long distance migrating small passerines is known to be under strong control from endogenous programmes (Berthold 1996, 2001). In Northern Europe birds avoid to cross large ecological barriers like deserts or large water bodies, long distance migrants migrate earlier in autumn in comparison to short distance migrants when the weather conditions are almost always acceptable for migration. Thus, one would expect a minimal variation of the passage time through the study area and limited influence of weather parameters on the migration intensity.

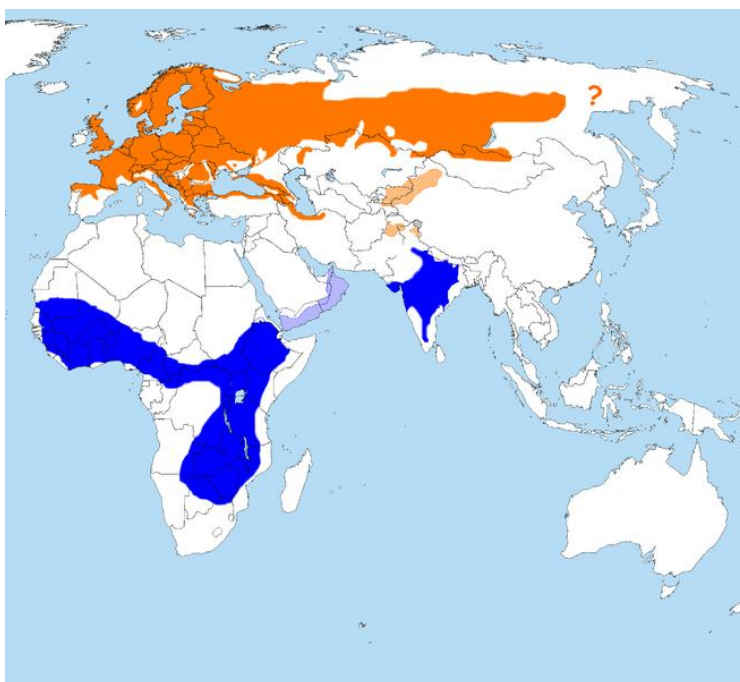

Figure 5.66 Distribution of Tree Pipit. Red – breeding areas of the nominate species, light red of *Anthus trivialis harringtoni*, blue – wintering areas, light blue – passage areas (adapted after Beaman and Madge (1998)).

FEHMARNBELT BIRDS

Spring 2009

During spring, the daytime migration intensity of Tree Pipits was rather low with peaks of 3.5 birds/hour on Fehmarn (Figure 5.67), compared to several peaks of > 100 birds/hour at the Lolland coast in autumn (Figure 5.69). During spring, migration intensity was higher at Fehmarn than at Lolland supporting the observation of more intensive (visible) movements of birds at the coast of departure.

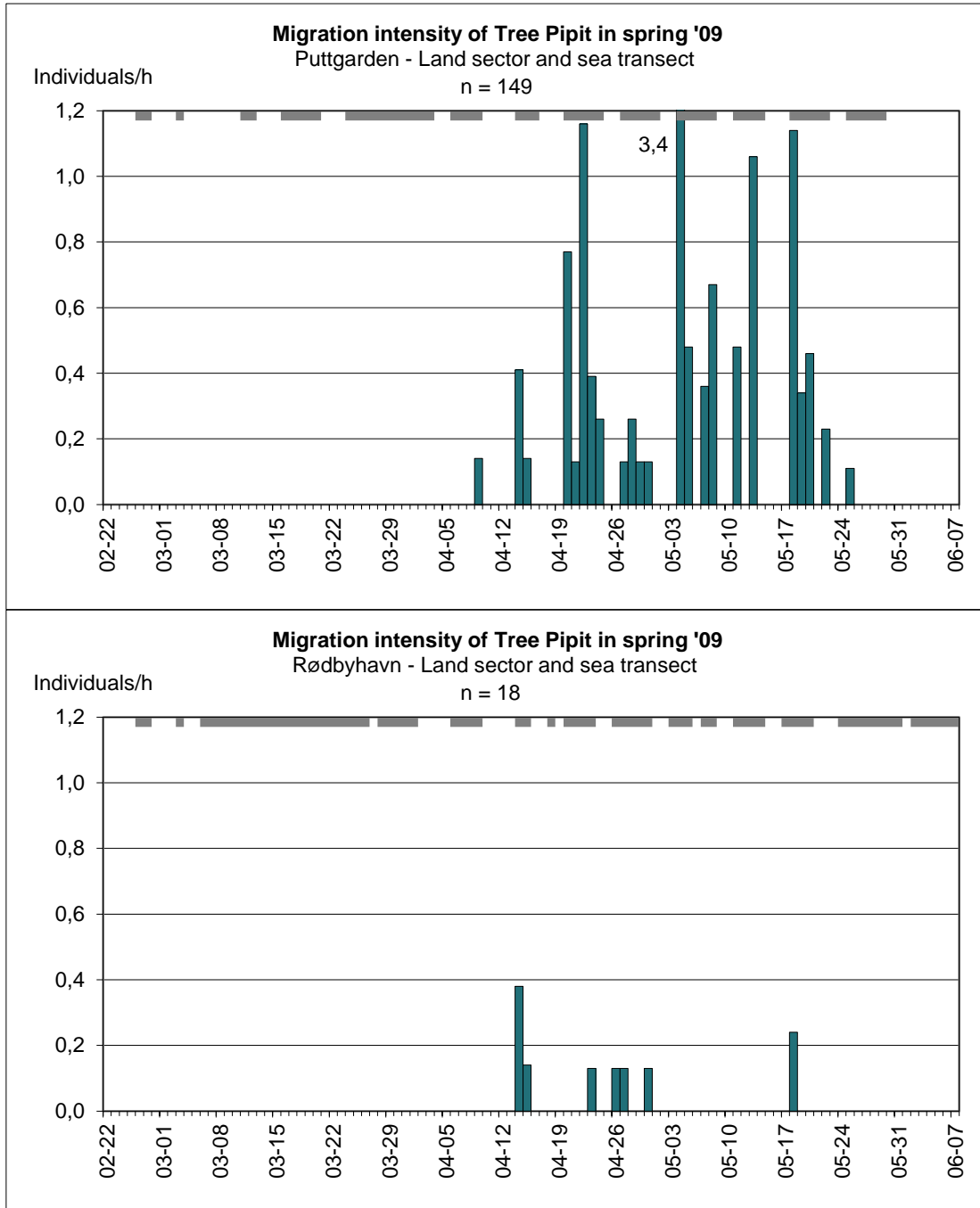

Figure 5.67 Dynamics of spring migration 2009 of Tree Pipit at Puttgarden (top) and Rødbyhavn (bottom). Days covered are indicated in grey on the upper axis.

FEHMARNBELT BIRDS

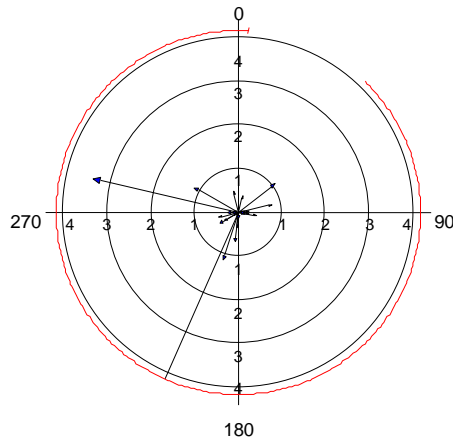

Figure 5.68 Relation between the intensity of Tree Pipit spring migration at Fehmarn and wind direction. The length of the arrows reflects the migration intensity, the direction of the arrows shows from where the wind is blowing. For details see Figure 5.31.

Model results of spring 2009

Low numbers at Lolland do not suffice for a modelling approach (see Appendix A.9), but the best model for Fehmarn including Julian day, projection of wind and visibility explains 54 % of the variation (see Appendix A.9). Here, Tree Pipits seem to favour westerly and southerly winds for migration.

Autumn 2009

The seasonal dynamics of Tree Pipit autumn migration through the study area is shown in Figure 5.69. The migration intensity registered at Fehmarn is considerably lower than at Lolland, and often peaks of counted migrants do not match between stations. This phenomenon may be explained by the behaviour of birds at the coasts of departure and arrival. At the departure coast (Lolland in autumn) birds start day time migration at low elevations, sometimes "searching" the coast for leaving points, and then start crossing passage while gaining height and soon escaping visual detection. Thus, at offshore locations and at the coast of arrival birds are already at high altitudes outside the range of visual detection. For some passerines this has been demonstrated with tracking radar data (Appendix B.1 to B.5).

The seasonal dynamics of nocturnal calling intensity is shown in Figure 5.70. The number of nocturnal calls is significantly higher at the Lolland harbour (0.51 calls/h) than the inland station (0.28 calls/h) (Mann-Whitney U test, $z=-2.095$, $p=0.036$, corrected for the effort, only days with simultaneous records at both sites are used). Nevertheless, calling intensities at these two locations are well correlated. Also peaks of migration recorded by visual observations coincide with peaks of nocturnal calling intensity (Figure 5.69, Figure 5.70).

FEHMARNBELT BIRDS

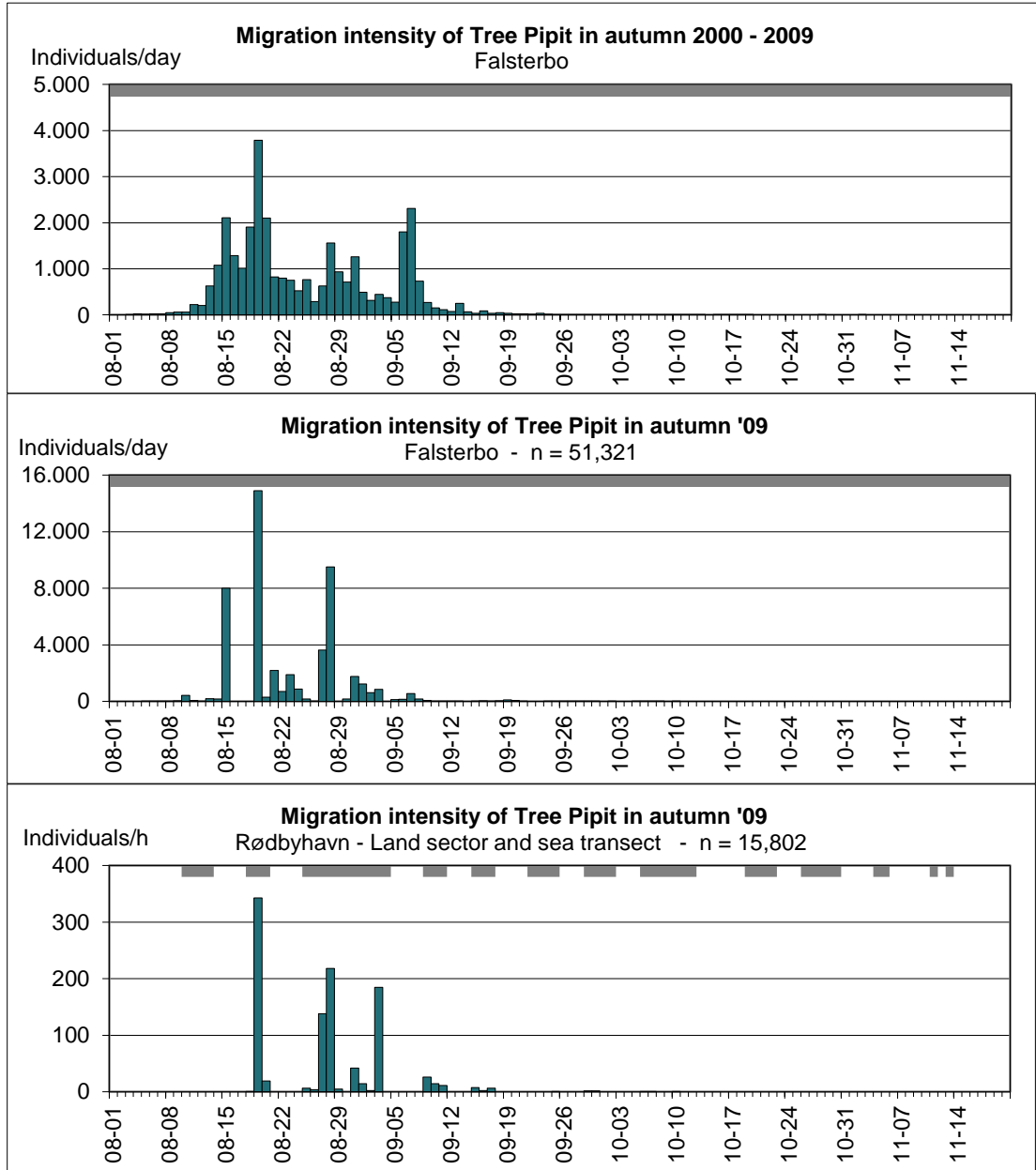

Figure 5.69 Dynamics of autumn migration of Tree Pipit at Falsterbo (average 2000-2009 and 2009; top) and Rødbyhavn (bottom). Data from Puttgarden are not shown as most values < 1 N /h. Days covered are indicated in grey on the upper axis.

FEHMARNBELT BIRDS

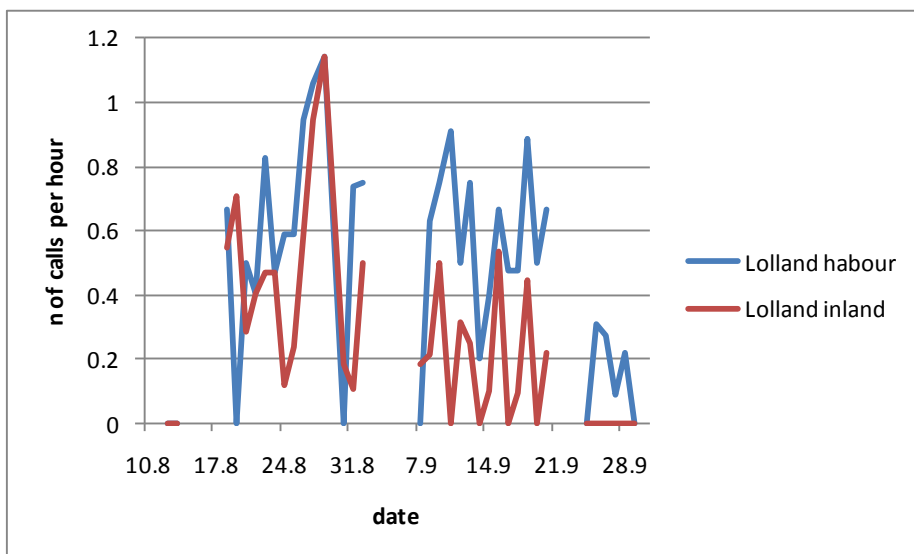

Figure 5.70 Seasonal dynamics of intensity of nocturnal calls of Tree Pipit at Lolland in autumn.

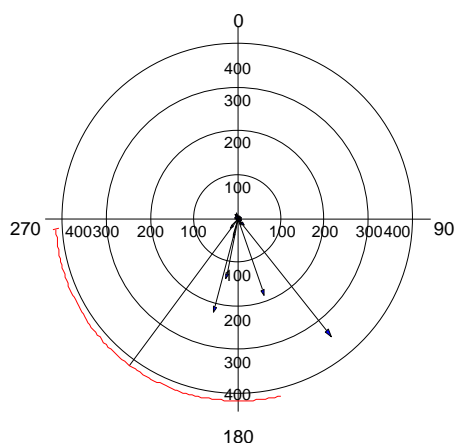

Figure 5.71 Relation between the intensity of Tree Pipit autumn migration at Lolland and wind direction. The length of the arrows reflects the migration intensity, arrow pointed at the direction from where the wind is blowing. For details see Figure 5.31.

The three parameters included in the GAM - Julian day, wind direction and speed, precipitation - explain a relatively small proportion of the total variation (about 30 %) compared to other species. The best model for Lolland with parameters Julian day, wind direction, wind speed and visibility explains 55 % of the variation (see Appendix A.9). Relation between wind direction and intensity of migration is shown on Figure 5.73.

Results 2009/2010

In 2010 the same method of recording and counting of night calls was used during both spring and autumn migration (Figure 5.72). The intensity of night calls on inland stations at Fehmarn and Lolland was comparable during spring and autumn migration, but the intensity of calls at the harbour locations varied between coasts and seasons, where the maximum intensity of calls was observed at the leaving coasts, Puttgarden in spring and Lolland in autumn. The registered intensity of calls offshore was much lower in comparison to coastal stations.

FEHMARNBELT BIRDS

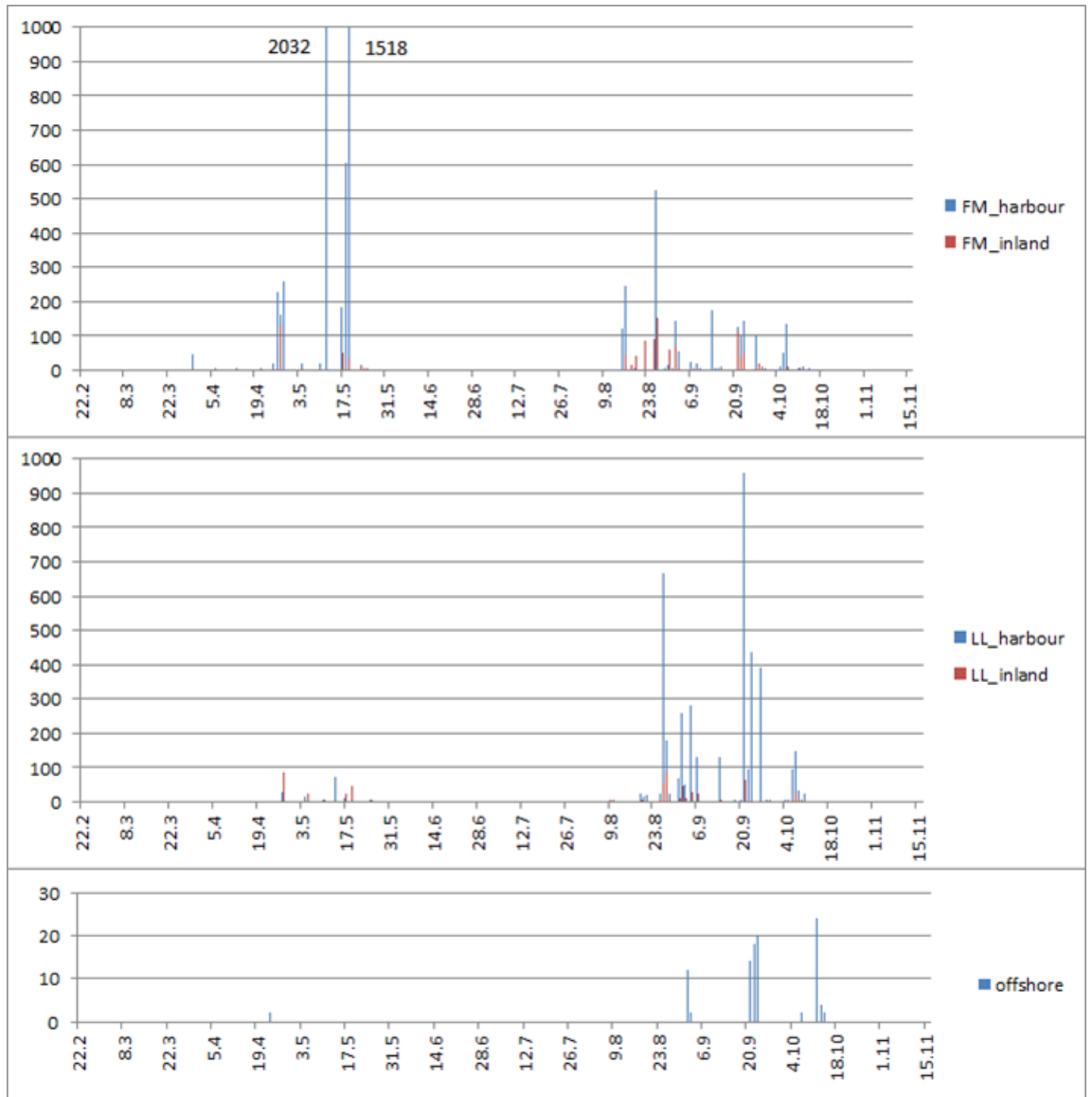

Figure 5.72 Intensity of nocturnal calls of Tree Pipits at Lolland (LL), Fehmarn (FM) and offshore recording stations in 2010.

The model based on data from two years 2009-2010 of spring migration at Lolland explains 51 % of the variation with parameters Julian day, wind direction (sin and cos), wind speed and temperature. It seems that large numbers of Tree Pipits were registered at Lolland in the situations with NW and W winds (see Appendix A.9). In spring at Puttgarden the model explains about 22 % of the variation with parameters Julian day, wind direction (sin and cos) and wind speed (see Appendix A.9).

During the autumn seasons the model explains 56 % of the variation at Puttgarden with parameters Julian day, wind direction (sin and cos), wind speed, and temperature trend during the last 2 days (see Appendix A.9). At Lolland the model explains 40 % of the variation with parameters Julian day, projections of wind vector and visibility (see Appendix A.9). Relations between intensity of migration and wind direction at Lolland and Fehmarn are shown on Figure 5.73.

FEHMARNBELT BIRDS

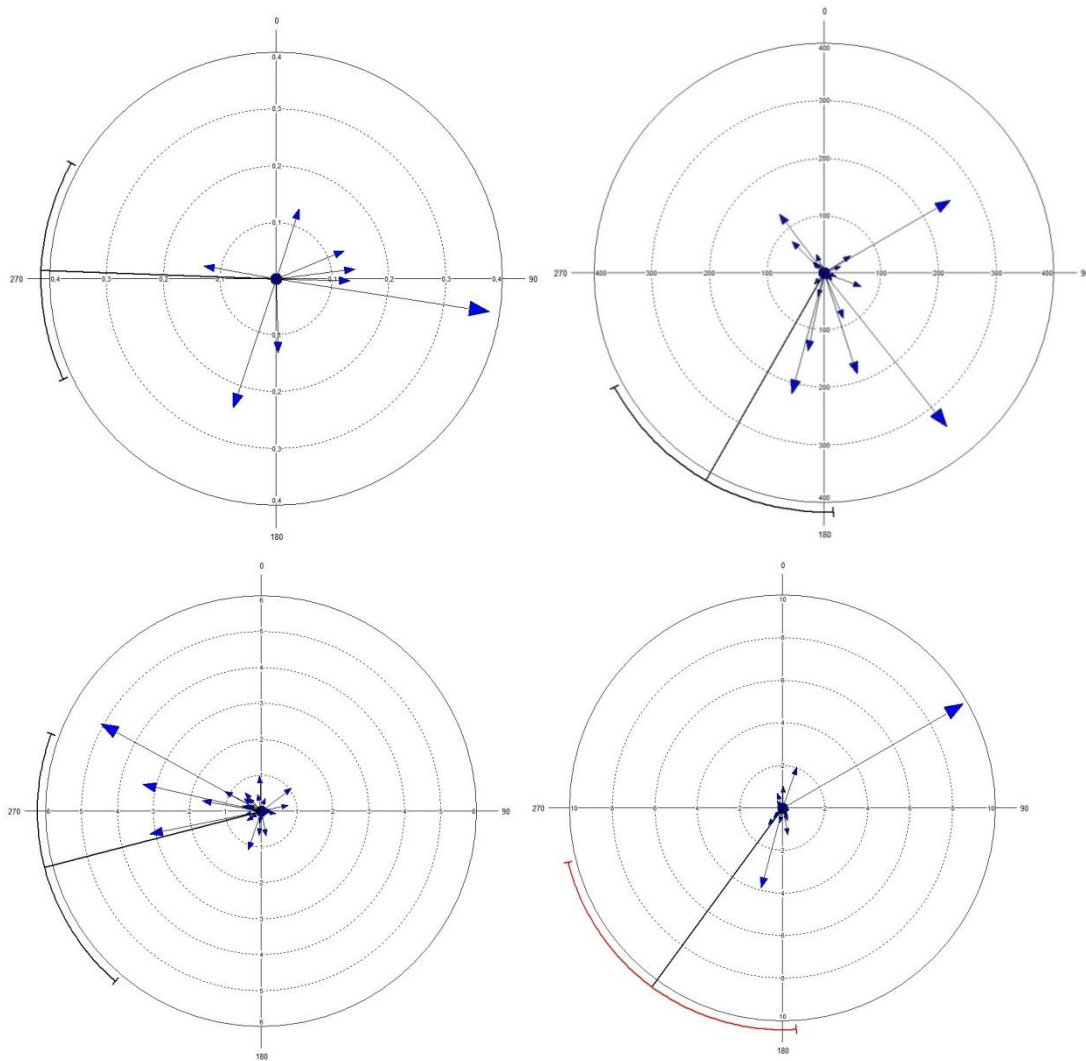

Figure 5.73 Relation between migration intensity of the Tree Pipit in spring and autumn and wind direction, 2009-2010. For details see Figure 5.31.

Discussion

Tree Pipit migration through the study area occurs both during day and night. With the data available it is difficult to estimate the relative importance of these two phases of migration, as the parameters calling intensity (night recordings) and migration intensity (daytime visual observations) are not directly comparable. In addition, both methods only cover the immediate vicinity of the observation location, limited by acoustic and visual detection distances. In addition, the motivation to call may influence the night acoustic results. For example, calling intensities differ between the inland and the shore locations; this may be due to two phenomena. The calling intensity increases when approaching a water body, and the calling intensity increases when birds are approaching illuminated areas. In summary, studying the Tree Pipit with the methods chosen will inevitably provide a local and limited focus of the wider region.

Tree Pipit as a long distance migrant has to comply with a tight migration schedule. On the basis of 2009 observations the model including weather parameters does not explain much of the data. This indicates that the timing of migration is not closely tied to weather parameters. The model based on data from two years (2009 and 2010) explains a relatively large proportion of the variation using weather

parameters. Nevertheless, the variation explained is lower than maximal values of explained variation for the short distance migrants (up to 90 %). This result might reflect the tendency for the long distance migrants to migrate under a broader range of weather conditions.

5.3.6 **Greenfinch**

The Greenfinch (*Chloris chloris*) is another example of a type 3 species, however, a short-distance migrant. It is a small passerine bird, mainly resident in Western Europe and migratory at northern parts of the area, such as Scandinavia. Migration of Greenfinches across the Fehmarnbelt area occurs during daytime. This species is one of passerine migrants recorded in high numbers during the two baseline years also according to external migration observations (see Appendix B.1 to B.5). This species was included in the analysis in order to compare the models of influence of weather parameters on the migration between a short distance migrant (here the Greenfinch) and a long distance migrant (Tree Pipit).

Results 2009/2010

In spring, the best model explained 50 % of the variation at Fehmarn with parameters Julian day, wind direction (sin and cos), wind speed and visibility included. Greenfinches were observed at Lolland in large numbers during strong northerly wind. At Lolland the best model explained 21 % of the variation with the parameters Julian day, projections of wind vector and cloud altitude included.

In autumn, at Fehmarn the best model explains only 9 % of the variation with parameters Julian day, wind direction (sin and cos), and wind speed included. At Lolland the best model explains 60 % of the variation with parameters Julian day, wind direction (sin and cos), wind speed, and precipitation during morning (6-12 am) included (see Appendix A.9).

Discussion

The Greenfinch models based on weather parameters explain a large percentage of the variation only at the leaving coasts where birds concentrate before departure. At the coasts of arrival the models explain only a low percentage of the variation, which is most likely due to a low detectability, and that birds are less concentrated than at the coast of departure.

5.3.7 **Discussion and conclusions**

Obviously, birds migrate according to an endogenous programme. However, their migration pattern is affected by external factors. Particularly regional and local weather conditions have a high impact on birds' migration behaviour along their migration route. Long-distance migrants have less flexibility to "wait" for the good weather conditions and consequently have to cope with sub-optimal conditions and impacts during migration, while short-distance migrants may be more plastic in their choices. The methods applied during the two years of baseline investigations are chosen to exemplarily deal with some relevant species, their numbers, migration directions and altitudes in order to explain migration patterns in the region. Further, the observation results were assessed with regard to migration conditions, e.g. weather, which may lead to a description of potential risks according to migration behaviour and weather influences.

There are several ecological groups of birds and corresponding different migration strategies to find. The present chapter deals with six exemplary species, which are representatives of their ecological groups and are also well registered during the two years of baseline investigations.

For the larger species it is assumed that results of visual observations, partly supported by results of radar investigations, correctly represent migration patterns

of these species in the area of the planned fixed link. For the smaller species like e.g. Tree Pipit and Green Finch detection limitations do apply and have to be considered.

The Common Eider is a short distance migrant preferably flying over water but is well able to cross larger landmasses. It has a flexible schedule and is therefore able to adjust migration time to more favourable weather conditions for migration. However, as a waterbird this species can cope with sudden bad weather conditions such as strong headwind, fog or rain more efficiently than e.g. a landbird, as it can simply go down on the water to rest. However, Common Eider does prefer to migrate during tailwinds and a drop in temperature in autumn will further trigger migration. Barriers along their migration route already exist, natural ones (e.g. the peninsula of Gedser Odde) as well as artificial ones like the offshore wind farms Rødsand I and II.

The Barnacle Goose, a long distance migrant, will start migration according to its endogenous programme and depending on the weather conditions at the departure sites. E.g. the main migration event of this species frequently occurs under tailwind conditions in the Wadden Sea. Once on migration Barnacle Geese will fly along their predestined migration route, but may be "blown" some degree off the perfect straight line. This species represents a migration pattern where the proportion of birds being registered at the Fehmarnbelt is expected to be affected by particular weather (i.e. wind) conditions. However, this does not mean that weather parameters explain migration intensities. In fact, during spring, model results are inconclusive, thus endogenous programs and climate conditions along the route determine migration. In turn, during autumn models do explain higher proportions of migration based on parameters such as wind direction and speed as well as temperature and precipitation.

The Common Buzzard, a short distance migrant also wintering in the vicinity of the planned fixed link will make use of favourable weather conditions for migratory movements. Mainly wind parameters in the models have explanatory power, thus tailwind situations are preferred and during headwind migration is low to non-existent. For comparison, the long distance migrant species Honey Buzzard has a tighter migration schedule and must cope with adverse weather conditions. Results show, that this species may also migrate in medium to strong headwinds actively flying low over water, instead of circling and soaring as it would be possible in favourable weather conditions. Thus, the explanatory power of the model is lower for this species. Consequently, Honey Buzzard may be expected to be more susceptible to additional impacts on its migration route than Common Buzzard.

Among the passerine species different migration strategies also exist. For the Tree Pipit, a long distance migrant, it is suggested that its migration schedule / endogenous programme will steer migration phenology to a large degree. Thus unfavourable weather will pose a threat to this species. As a daytime migrant, it will cross water bodies preferably at short distances while during night this may not play an important role. Model results have explanatory power. However, for each season and location the combination of factors is different and thus results not very conclusive.

For the Greenfinch, a short-distance daytime migrant, model results are explanatory, but only at the leaving coasts.

5.4 Summary

It is beyond the scope of this report and the baseline investigations to sufficiently cover the topic on bird migration and weather. However, being aware of the current concepts of this issue, investigations had been designed to cope with at least some of the facts, which could potentially present additional impacts onto this migration period of birds which is already a large challenge for the physiological and physical abilities of birds. Consequently, the issues of the influence of wind, the influence of all components of weather and the particular conditions at departure and arrival coasts was looked upon.

The analyses of bird behaviour and wind confirm that birds make use of favourable winds and are affected by unfavourable winds.

For waterbirds, effects of wind are less critical. They do influence overall migration intensities, and they seem to influence the distance to the coast, i.e. onshore winds will drive birds closer to the coast as other wind directions. This way the choices of waterbirds are influenced and limited by wind and this may play a role when it comes to further impacts imposed by obstacles on their migration routes.

For landbirds the Fehmarnbelt provides the shortest crossing distance. Results show, that wind direction has almost no influence of migrating bird intensities, which could suggest, that neither location is a culmination point for land birds such as headlands like Falsterbo or Ottenby, at which birds accumulate during unfavourable wind situations. As for the migration directions of landbirds, coasting or crossing seems to be influenced by wind directions, however, results for Puttgarden are somewhat contrary to expectation, that birds coast during offshore wind (wind blowing from land to water), and a few species seem to prefer to leave the Fehmarn coast during headwind. At Rødbyhavn, results rather support, that birds coast during onshore drift and depart during tailwind situations or easterly crosswinds.

The modelling of weather influences on bird migration of six selected species suggests, that models are better able to explain the migration of short-distance migrants, which have the flexibility of choosing favourable weather, while model results long-distance migrants, which have to adhere to a tighter time-schedule driven by factors other than weather, are rather inconclusive. However, even when models work, they are far from explaining or even forecasting migration, which again is beyond the scope of this report.

6 REFERENCES

- Åkesson, S. and Hedenström, A. 2000. Wind selectivity of migratory flight departures in birds. *Behavioural Ecology and Sociobiology*, 47, 140-144.
- Åkesson, S., Jonzén, N., Pettersson, J., Rundberg, M. and Sandberg, R. 2006. Effects of magnetic manipulations on orientation: comparing diurnal and nocturnal passerine migrants on Capri, Italy in autumn. *Ornis Svecica*, 16, 55-61.
- Alerstam, T., Bauer, C.A. and Roos, G. 1974. Spring Migration of Eiders *Somateria mollissima* in Southern Scandinavia. *Ibis*, 116, 194-210.
- Alerstam, T. 1975. Crane *Grus grus* migration over sea and land. *Ibis*, 117, 489-495.
- Alerstam, T., Pettersson, S.-G. 1977. Why do migrating birds fly along coastlines?. *Journal of theoretical Biology*, 65: 699-712.
- Alerstam, T. 1978. Analysis and theory of visible bird migration. *Oikos*, 30, 273-394.
- Alerstam T. 1993. Bird migration. Cambridge University Press.
- Baisner, A.J., Andersen, J.L., Findsen, A., Yde Granath, S.W., Madsen, K.Ø. and Desholm, M. 2010. Minimizing collision risk between migrating raptors and marine wind farms: development of a spatial planning tool. *Environmental Management*, 46, 801-808.
- Batschelet, E. 1981. Circular Statistics in Biology. London, Academic Press.
- Battley, P. F., Dekinga, A., Dietz, M. W., Piersma, T., Tang, S., Hulsman, K. 2001. Basal metabolic rate declines during long-distance migratory flight in Great Knots. *The Condor*, 103: 838-845. Beaman, M. and Madge, S. 1998. *Handbuch der Vogelbestimmung*. Ulmer-Stuttgart, 579 p.
- Bellebaum, J., Diederichs, A., Kube, J., Schulz, A., Nehls, G. 2006. Flucht- und Meidedistanzen überwinternder Seetaucher und Meeresenten gegenüber Schiffen auf See. *Ornithologischer Rundbrief Mecklenburg-Vorpommern*, 45 (1): 86-90.
- Bergman, G. and Donner, K. 1964. An analysis of the spring migration of the Common Scoter and the Longtailed Duck in southern Finland. *Acta Zoologica Fennica*. 105: 1-59.
- Bergman, G. 1974. The spring migration of the Long-tailed Duck and Common Scoter in Western Finland. *Ornis Fennica* 51: 129-145.
- Bergman, G. 1978. Effects of wind conditions on the autumn migration of waterfowl between the White Sea area and the Baltic region. *Oikos* 30: 393-397.
- Berndt, R. K., Hein, K., Koop, B. and Lunk, S. 2005. *Die Vögel der Insel Fehmarn*. Husum Druck- und Verlagsgesellschaft, Husum. 347 p.
- Berthold, P. 1996. Control of bird migration. Chapman & Hall, London.
- Berthold, P. 2001. Bird migration: a general survey. Oxford University Press.
- Berthold, P., Gwinner, E., and Sonnenschein, E. 2003. *Avian Migration*. Berlin. Springer.
- Bolshakov, C. V. 1977 Study of nocturnal bird migration (methodological aspects). In: Iljichev, V. D. (Ed.). *Methods of bird migration research*. Moscow; 1977. p. 77-96. In Russian.

FEHMARNBELT BIRDS

- Bowlin, M.S., Bisson, I.A., Shamoun-Baranes, J., Reichard, J.D., Sapir, N., Marra, P.P., Kunz, T.H., Wilcove, D.S., Hedenström, A., Guglielmo, C.G., Akesson, S. and Ramenofsky, M. 2010. Grand challenges in migration biology. *Integrative and Comparative Biology*, 1-19.
- Bruderer, B. 1997. The study of bird migration by radar. Part 1: The technical basis. *Naturwissenschaften*, 84, 1-8.
- Bruderer, B. 1997. The study of bird migration by radar. Part 2: Major achievements. *Naturwissenschaften*, 84: 45-54.
- Bruderer, B., Liechti, F. 1998. Flight behaviour of nocturnally migrating birds in coastal areas - crossing or coasting. *Journal of Avian Biology*, 29: 499-507.
- Bruderer, B., Liechti, F. 1999. Bird migration across the Mediterranean. In: Adams, N.J. & Slotow, R.H. (eds) *Proc. 22 Int. Ornithol. Congr.*, Durban: 1983-1999. Johannesburg: BirdLife South Africa.
- Bruderer B. 2001. Recent studies modifying current views of nocturnal bird migration in the Mediterranean. *Avian Ecology of Behaviour*, 7:11-25.
- Bruderer, B. 2007. Adapting a military tracking radar for ornithological research - The case of the 'Superfledermaus'. p. 32-37 in J.M. Ruth (Ed.): *Applying radar technology to migratory bird conservation and management: Strengthening and expanding a collaborative*. USGS, Biological Resource Discipline, Fort Collins, Colorado, USA.
- Bruderer, B., Peter, D., Boldt, A. and Liechti, F. 2010. Wing-beat characteristics of birds recorded with tracking radar and cine camera. *Ibis*, 152, 272-291.
- BSH (Bundesamt für Seeschifffahrt und Hydrographie) 2003. Standarduntersuchungskonzept für die Untersuchung und Überwachung der Auswirkungen von Offshore Windenergieanlagen auf die Meeresumwelt (StUK 3). Bundesamt für Seeschifffahrt und Hydrographie, Hamburg und Rostock. 59 p.
- BSH (Bundesamt für Seeschifffahrt und Hydrographie) 2007. Standarduntersuchungskonzept für die Untersuchung und Überwachung der Auswirkungen von Offshore Windenergieanlagen auf die Meeresumwelt (StUK 3). Bundesamt für Seeschifffahrt und Hydrographie, Hamburg und Rostock. 59 p.
- Bunker-Popma, K. 2006. Scoter, *Melanitta ssp.*, migrations interrupted by Confederation Bridge: an update. *Canadian Field-Naturalist* 120(2):432-433.
- Busche, G., Berndt R. K. and Nehls, G. 1993. Trauerente – *Melanitta nigra*. In: Berndt, R. K. and Busche, G. 1993: *Vogelwelt Schleswig-Holsteins*, Bd. 4, 82-88. Neumünster.
- Cramp, S. and Simmons, K.E.L 1977. *The birds of western Palaearctic 1.* – Oxford University Press. 960 pp.
- Day, R.H., Rose, J.R., Prichard, A.K., Blaha, R.J. and Cooper, B.A. 2004. Environmental effects on the fall migration of eiders at Barrow, Alaska. *Marine Ornithology*, 32, 13-24.
- Desholm, M., Christensen, T.K., Scheiffarth, G., Hario, M., Andersson, Å., Ens, B., Camphuysen, C.J., Nilsson, L., Waltho, C.M., Lorentsen, S.H., Kuresoo, A., Kats, R.K.H., Fleet, D.M. and Fox, A.D. 2002. Status of the Baltic/Wadden Sea population of the Common Eider *Somateria m. mollissima*. *Wildfowl*, 53, 167-203.
- Desholm, M. 2009. Avian sensitivity to mortality: prioritising migratory bird species for assessment at proposed wind farms. *Journal of Environmental Management*, 90, 2672-2679.

FEHMARNBELT BIRDS

- Dierschke, V. 2002: Migration of Red-throated Divers *Gavia stellata* and Black-throated Divers *G. arctica* near Helgoland (SE North Sea). *Vogelwelt* 123: 203 – 211.
- Dierschke, V., Daniels, J.-P. 2003. Zur Flughöhe ziehender See-, Küsten- und Greifvögel im Seegebiet um Helgoland. *Corax*, Sonderheft 2, 19: 35-41.
- Dierschke, V., Garthe, S. and Mendel, B. 2006. Possible conflicts between offshore wind farms and seabirds in the German sectors of North Sea and Baltic Sea. p. 117-144 in Köller, J., Köppel, J. and Peters, W. (Eds): *Offshore wind energy -research on environmental impacts*. Springer Verlag, Germany.
- DOF 2010: Dansk Ornitologisk Forening (DOF) (unpubl. <http://www.dofbasen.dk>.) Data from Nakskov Fjord, Hyllekrog-Rødsand, Maribosøerne, Smålandsfarvandet nord for Lolland, Guldborg Sund, Bøtø Nor (accessed on October 6, 2010).
- Dolnik, V.R. 1990. Bird migration across arid and mountainous regions of Middle Asia and Kazakhstan. In: Gwinner, E. (ed). *Bird migration: physiology and ecophysiology*. Springer, Berlin Heidelberg New York. Pp 368-386.
- Drent R.H., Eichhorn, G., Flagstad, A., Van der Graaf, A.J., Litvin, K.E. and Stahl, J. 2006. Migratory connectivity in Arctic geese: spring stopovers are the weak links in meeting targets for breeding. *J Ornithol.* DOI 10.1007/s10336-007-0223-4.
- Drewitt, A. L., Langston, R.H.W. 2008. Collision Effects of Wind-power Generators and Other Obstacles on Birds. *Annals of the New York Academy of Science* 1134: 233–266.
- Erickson, W.P., Johnson, G.D., Strickland, M.D., Young, D.P., Sernka, K.J. and Good, R.E. 2001. Avian collisions with wind turbines: a summary of existing studies and comparisons to other sources of avian collision mortality in the United States. National Wind Coordinating Committee (NWCC) Resource Document. Washington, D.C., USA. 67 p.
- Erni, B., Liechti, F., Underhill, L.G. and Bruderer, B. 2002. Wind and rain govern the intensity of nocturnal bird migration in Central Europe – a log-linear regression analysis. *Ardea*, 90, 155-166.
- Erni, B., Liechti, F., Bruderer, B. 2005. The role of wind in passerine autumn migration between Europe and Africa. *Behavioral Ecology*, 16: 732-740.
- Federal Maritime and Hydrographic Agency. 2004. Standards for environmental impact assessments – impacts of offshore wind-turbines on the marine environment. BSH, Hamburg, Rostock, 51 pp.
- Federal Maritime and Hydrographic Agency. 2007. Standard – Investigation of the impacts of offshore wind turbines on the marine environment (STUK 3). BSH, Hamburg, Rostock, 57 pp.
- Feige, N., van der Jeugd, H. P., van der Graaf, A. J., Larsson, K., Leite, A., Stahl, J. 2008. Newly established breeding sites of Barnacle Goose *Branta leucopsis* in North-western Europe - an overview of breeding habitats and colony development. *Vogelwelt*, 129: 244-252.
- Femern A/S and Landesbetrieb Strassenbau und Verkehr Schleswig-Holstein (LBV) (2010). Proposal for environmental investigation programme for the fixed link across Fehmarnbelt (coast-coast) EIA Scoping Report.
- Follestad, A., Flagstad, Ö., Nygard, T., Reitan, O. and Schulze, J. 2007. Vindkraft og fugl på Smøla 2003-2006 (In Norwegian with English Summary). NINA Rapport 248. 78 p.

- Fortin, D., F. Liechti, B. Bruderer, 1999. Variation in the nocturnal flight behaviour of migratory birds along the northwest coast of the Mediterranean Sea. *Ibis* 141 (3): 480-488.
- Fox, A.D., Ebbinge, B.S., Mitchell, C., Heinicke, T., Aarvak, T., Colhoun, K., Clausen, P., Dereliev, S., Faragó, S., Koffijberg, K., Kruckenberg, H., Loonen, M., Madsen, J., Mooij, J., Musil, P., Nilsson, L., Pihl, S. and van der Jeugd, H. 2010. Current estimates of goose population sizes in western Europe, a gap analysis and an assessment of trends. *Ornis Svecica*, 20, 115-127.
- Garthe, S. and Hüppop, O. 2004. Scaling possible adverse effects of marine wind farms on seabirds: developing and applying a vulnerability index. *Journal of Applied Ecology*, 41, 724-734.
- Gatter, W. 2000. Vogelzug und Vogelbestände in Mitteleuropa. 30 Jahre Beobachtung des Tagzugs am Randecker Maar. Aula Verlag, 656 p.
- Gehring, J., Kerlinger, P. and Manville, A.M. 2009. Communication towers, lights, and birds: successful methods of reducing the frequency of avian collisions. *Ecological Applications*, 19, 505-514.
- van der Graaf, A.J., Stahl, J., Klimkowska, A., Bakker, J.P. and Drent, R.H. 2006. Surfing on a green wave – how plant growth drives spring migration in the Barnacle Goose *Branta leucopsis*. *Ardea*, 94, 567–577.
- Green, M., Alerstam, T., Gudmundsson, G. A., Hedenström, A., Piersma, T. 2004. Do arctic waders use adaptive wind drift?. *Journal of Avian Biology*, 35: 305-315.
- Green, M. 2004. Flying with the wind - spring migration of arctic-breeding waders and geese over South Sweden. *Ardea*, 92 (2): 145-160.
- Gwinner, E. 1986. Circannual rhythms. Endogenous annual clocks in the organization of seasonal processes. Berlin: Springer Verlag. 154 p.
- Haas, D. and Schürenberg, B. (Hrsg.) 2008. Stromtod von Vögeln - Grundlagen und Standards zum Vogelschutz an Freileitungen. *Ökologie der Vögel, Sonderband 1/2008*.
- Hake, M., Kjellen, N. and Alerstam, T. 2003. Age-dependent migration strategy in honey buzzards *Pernis api_orus* tracked by satellite. *Oikos*, 103, 385-396.
- Hawkes, L., Balachandran, S., Batbayar, N., Butler, P. J., Frappell, P. B., Milsom, W. K., Tseveenmyadag, N., Newman, S. H., Scott, G. R., Sathiyaselvam, P., Takekawa, J. Y., Wikelski, M., and Bishop, C. M. 2011. The trans-Himalayan flights of Bar-headed geese (*Anser indicus*). *PNAS* www.pnas.org/cgi/doi/10.1073/pnas.1017295108
- Hedenström, A. and Alerstam, T. 1992. Climbing performance of migrating birds as a basis for estimating limits for fuel-carrying capacity and muscle work. *Journal of Experimental Biology*, 164, 19-38.
- Hedenström, A., Alerstam, T., Green, M. and Gudmundsson, G.A. 2002. Adaptive variation of airspeed in relation to wind, altitude and climb rate by migrating birds in the Arctic. *Behavioural Ecology and Sociobiology*, 52, 308-317.
- Hicklin, P. and Bunker-Popma, K. 2001. The spring and fall migrations of Scoters, *Melanitta* ssp., at Confederation Bridge in Northumberland Strait between New Brunswick and Prince Edward Island. *Canadian Field-Naturalist* 115(3):436-445.

- Hötker, H., Thomsen, K.M. and Köster, H. 2004. Auswirkungen regenerativer Energiegewinnung auf die biologische Vielfalt am Beispiel der Vögel und der Fledermäuse - Fakten, Wissenslücken, Anforderungen an die Forschung, ornithologische Kriterien zum Ausbau von regenerativen Energiegewinnungsf. NABU Deutschland, Bundesamt für Naturschutz, Bonn. 80 p.
- Hubalek, Z. 2003. Spring migration of birds in relation to North Atlantic Oscillation. *Folia Zoologica* 52, 287-298.
- Hüppop, O., Hill, R., Hüppop, K., Jachmann, F. 2009. Auswirkungen auf den Vogelzug - Begleitforschung im Offshore-Bereich auf Forschungsplattformen in der Nordsee (FINOBIRD). Abschlussbericht, Institut für Vogelforschung, Helgoland. 278 p.
- Jacoby, V. and Žalakevičius, M. 1992. Radar and visual surveys of Common Scoter moult migration within Eastern Baltic. - *Acta Ornithologica Lituanica* 5-6: 35-37.
- Jenni, L. 1984. Herbstzugmuster von Vögeln auf dem Col de Bretolet unter besonderer Berücksichtigung nach brutzeitlicher Bewegungen. *Ornithol. Beob.*, 81, 183-213.
- Jenni-Eiermann, S., Almasi, B., Maggini, I., Salewski, V., Bruderer, B., Liechti, F., Jenni, L. 2010. Numbers, foraging and refuelling of passerine migrants at a stopover site in the western Sahara: diverse strategies to cross a desert. *Journal of Ornithology* online doi.org/10.1007/s10336-010-0572-2.
- Joensen, A. H. 1973. Moults migration and wing-feather moult of seaducks in Denmark. *Danish Revue of Game Biology* 8(4): 1-42.
- Kahlert, J., Hüppop, K., Hüppop, O. 2005. Construction of a fixed link across Fehmarnbelt: preliminary risk assessment on birds. Commissioned by The Danish Ministry of Transport and Energy, and the German Federal Ministry of Transport, Building and Housing. NERI, DK. 86 p.
- Kahlert, J., Desholm, M., Petersen, I.K. and Fox, A.D. 2006. Data on bird numbers, distribution and flight patterns at Nysted offshore wind farm. Annual Report. NERI Report, commissioned by DONG Energy, DK.
- Kahlert, J., Petersen, I.K. and Desholm, M. 2007. Effects on birds of the Rødsand 2 off-shore wind farm: Environmental Impact Assessment. NERI report.
- Kaiser, M.J., Elliott, A.J., Galanidi, M., Rees, E.I.S., Caldow, R.W.G., Stillman, R.A., Sutherland, W.J. and Showler, D.A. 2005. Predicting the displacement of Common Scoter *Melanitta nigra* from benthic feeding areas due to offshore windfarms. University of Wales Bangor Report to COWRIE.
- Karlsson, L., Persson, K., Pettersson, J. and Walinder, G. 1988. Fat-weight relationships and migratory strategies in the Robin *Erithacus rubecula* at two stop-over sites in south Sweden, *Ringling & Migration*, 9: 3, 160-168.
- Kjellen, N. 1999. Different migration strategies among Swedish Common Buzzards *Buteo buteo* revealed by the proportion of white birds. *Ornis Svecica*, 9, 11-18.
- Kjellen, N. 2007. Migration counts at Falsterbo in the autumn of 2007. Meddelande Nr 240 fran Falsterbo Fagelstation.
- Kjellen, N. 2009. Migration counts at Falsterbo in the autumn of 2007. Meddelande Nr 253 fran Falsterbo Fagelstation.
- Klem, D. Jr. 2009. Avian mortality at windows: the second largest human source of bird mortality on earth. in Rich, T.D., Arizmendi, C., Demarest, D. and Thompson, C. (eds.) 2009. Tundra to Tropics: connecting birds, habitats and people. Proc. 4th int. Partners in Flight Conference, 13-16 Feb 2008, McAllen.

FEHMARNBELT BIRDS

- Kokhanov, V. 1983. Peculiarities of the summer migration of the Common Scoter in different regions of the White Sea. Communications of the Baltic Commission for the Study of Bird Migration 16:14-23.
- Koop, B. (1985): Rast und Zug der Zwergmöwe (*Larus minutus*) am Großen Plöner See. *Corax* 11: 70-78.
- Koop, B. 2002 - 2010. Vogelzug über Schleswig-Holstein. Yearly Reports. Ornithologische Arbeitsgemeinschaft für Schleswig-Holstein und Hamburg, e.V.
- Koop, B. 2002. Vogelzug über Schleswig-Holstein. Räumlicher und zeitlicher Ablauf des sichtbaren Vogelzuges nach archivierten Daten von 1950-2002. Gutachten im Auftrag des Landesamtes für Natur und Umwelt Schleswig-Holstein, Flintbek.
- Koop, B. 2004. Vogelzug über Schleswig-Holstein - Der Fehmarn-Belt - ein 'bottle neck' im europäischen Vogelzugsystem. Ornithologische Arbeitsgemeinschaft für Schleswig-Holstein und Hamburg, e.V. 8 p.
- Krüger, T. and Garthe, S. 2002: Das Vorkommen ausgewählter See- und Küstenvögel vor Wangerooge während des Herbstzuges: der Einfluss von Windrichtung und Windstärke. *Journal für Ornithologie*, 143 (2): 155-170.
- Kumari, E. 1979. Moults and moult migration of waterfowl in Estonia. *Wildfowl* 30: 90-98.
- Laursen, K., Pihl, S., Durinck, J., Hnasen, M., Skov, H., Frikke, J., Danielsen, F. 1997. Numbers and distribution of waterbirds in Denmark 1987-1989. *Danish Review of Game Biology* 15(1).
- Lehman, R.N., Kennedy, P.L. and Savidge, J.A. 2007: The state of the art in raptor electrocution research: A global review. *Biological Conservation*, 136, 159-174.
- Leopold M.F., Baptist H.J.M., Wolf P.A. & Offringa H. 1995: De Zwarte Zeeëend *Melanitta nigra* in Nederland. *Limosa* 68: 49-64.
- Liechti, F. 2006. Birds: blowin' by the wind?. *Journal of Ornithology*, 147 (2): 202-211.
- Liechti, F., Schmaljohann, H. 2007. Wind-governed flight altitudes of nocturnal spring migrants over the Sahara. *Ostrich*, 78 (2): 337-341.
- Lovvorn, J.R. and Jones D.R. 1994. Biomechanical conflicts between adaptations for diving and aerial flight in estuarine birds. *Estuaries and Coasts*, 17, 62-75.
- Lundberg, P. 1988. The evolution of partial migration in birds. *Trends in Ecology and Evolution*, 3,172-175.
- MacKinnon, C. and Kennedy, A. 2006: An observation of the spring 2006 migration of Black Scoter, *Melanitta nigra*, in Northumberland Strait, interrupted by the Confederation Bridge, New Brunswick – Prince Edward Island. *Canadian Field-Naturalist* 120(2):233-234.
- Madders, M. and Whitfield, D.P. 2006. Upland raptors and the assessment of wind farm impacts. *Ibis*, 148, 43-56.
- Masden, E.A., Haydon, D.T., Fox, A.D., Furness, R.W., Bullman, R. and Desholm, M. 2009. Barriers to movement: impacts of wind farms on migrating birds. *ICES Journal of Marine Science*, 66, 746-753.
- Mebis, T. and Schmidt, D. 2006. Die Greifvögel Europas, Nordafrikas und Vorderasiens. Kosmos Verlag, Stuttgart. 495 p.

- Meltofte, H. 2008. A personal view on how waders migrate using the autumn passage of Northern Dunlins as an example. Wader Study Group Bull. 115(1): 29–32.
- Meltofte, H. and Rabøl, J. 1977: Vejrets indflydelse på efterårstrækket af vadefugle ved Blåvandshuk, med et forsøg på en analyse af trækkets geografiske oprindelse. Dansk Orn. Foren. Tidsskr. 71: 43-63.
- Mendel, B., Sonntag, N., Wahl, J., Schwemmer, P., Dries, H., Guse, N., Muller, S. and Garthe, S. 2008. Profiles of seabirds and waterbirds of the German North and Baltic Seas. Bundesamt für Naturschutz, Bonn- Bad Godesberg. 427 pp.
- Meyer, S. K., Spaar, R., Bruderer, B. 2000. To cross the sea or to follow the coast? Flight directions and behaviour of migrating raptors approaching the Mediterranean Sea in autumn. Behaviour, 137: 379-399.
- Mukhin, A., N. Chernetsov, D. Kishkinev 2008. Acoustic information as a distant cue for habitat recognition by nocturnally migrating passerines during landfall. Behavioural Ecology, 19(4): 716-723.
- Nehls, H.W. and Zöllick, H. 1990. The moult migration of the Common Scoter (*Melanitta nigra*) off the coast of the GDR. Baltic Birds 5 (Proceedings of the 5th Conference of the Study and Conservation of migratory birds of the Baltic basin, Riga, 5.-10. Oct 1987, Vol 2; 36-46). Riga, Estonia.
- Neumann, R., Kube, J., Liechti, F., Steuri, T., Wendeln, H. & H. Sordyl 2009: Entwicklung einer Methode zur automatischen Quantifizierung des Vogelzugs im Bereich von Offshore-Windparks und der Barrierewirkung der technischen Anlagen für den Vogelzug mittels fast fixed beam Radar. Abschlussbericht. Forschungsvorhaben des Bundesministeriums für Umwelt, Naturschutz und Reaktorsicherheit (FKZ 0327632). Neu Broderstorf.
- Newton, I. 2008. Migration Ecology of birds. Academic Press, Amsterdam, The Netherlands. 976 p.
- Noer, H. 1991. Distributions and movements of Eider *Somateria mollissima* populations wintering in Danish waters, analysed from ringing recoveries. Danish Review of Game Biology, 14, 1-32.
- Oriana 3.0 2009. Kovach Computing Services, Anglesey, Wales.
- Payevsky, V. A. 1998. Age structure of passerine migrants at the eastern Baltic coast: the analysis of the "coastal effect". Ornis Svecica 8:171-178.
- Pelletier, D., Guillemette, M., Grandbois, J.M. and Butler P.J. 2008. To fly or not to fly: high flight costs in a large sea duck do not imply an expensive lifestyle. Proc. R. Soc. B, 275, 2117-2124.
- Pennycuik, C. J., Alerstam, T., Larsson, B. 1979: Soaring migration of the Common Crane *Grus grus* observed by radar and from an aircraft. Ornis Scandinavica, 10, 241-251.
- Pennycuik, C.J. and Battley P.F. 2003. Burning the engine: a time-marching computation of fat and protein consumption in a 5420-km non-stop flight by great knots, *Calidris tenuirostris*. Oikos, 103, 323-332.
- Petersen, I.K., Christensen, T.K., Kahlert, J., Desholm, M. and Fox, A.D. 2006. Final results of bird studies at the offshore wind farms at Nysted and Horns Rev, Denmark. NERI Report, commissioned by DONG Energy and Vattenfall A/S, DK. 166 p.
- Petersen, I.K. and Fox, A.D. 2007. Changes in habitat utilisation around the Horns Rev 1 offshore wind farm, with particular emphasis on the Common Scoter. Report request. Commissioned by Vattenfall A/S.

- Prange, H. 2010: Zug und Rast des Kranichs *Grus grus* und die Veränderungen in vier Jahrzehnten. *Vogelwelt* 131: 155-167.
- R Development Core Team 2010. R: A language and environment for statistical computing. R Foundation for Statistical Computing, Vienna, Austria. ISBN 3-900051-07-0, URL <http://www.R-project.org>.
- Ramenofsky, M. and Wingfield, J.C. 2007. Regulation of migration. *Bioscience*, 57, 135-143.
- Richardson, W.J. 1978. Timing and amount of bird migration in relation to weather: a review. *Oikos*, 30, 224-272.
- Richardson, W.J. 1990. Timing of bird migration in relation to weather: updated review. P. 78-102 in Gwinner, E. (Ed.): *Bird migration - physiology and ecophysiology*. Springer Verlag Berlin Heidelberg, Germany. p.
- Saino, N., Rubolini, D., Jonzén, N., Ergon, T., Montemaggiore, A., Stenseth, N.C. and Spina, F. 2007. Temperature and rainfall anomalies in Africa predict timing of spring migration in trans-Saharan migratory birds. *Clim Res*, 35, 123-134.
- Salomonsen, F. 1968. The moult migration. *Wildfowl* 19: 5-24.
- Sandberg, R. 1994. Interaction of body condition and magnetic orientation in autumn migrating Robins, *Erithacus rubecula*. *Animal Behaviour* 47: 679-686.
- Schmaljohann, H., F. Liechti and B. Bruderer, 2007. Songbird migration across the Sahara: the non-stop hypothesis rejected! *Proc. R. Soc. B*, 274, 735-739
- Schmaljohann, H., Liechti, F., Bächler, E., Steuri, T. and Bruderer, B. 2008. Quantification of bird migration by radar - a detection probability problem. *Ibis*, 150, 342-355.
- Schmaljohann, H., Liechti, F. and Bruderer, B. 2009. Trans-Sahara migrants select flight altitudes to minimize energy costs rather than water loss. *Behavioural Ecology and Sociobiology*, DOI 10.1007/s00265-009-0758-x.
- Scott, D. & G. Scheiffarth 2009. Bar-tailed Godwit *Limosa lapponica*. In: S. Delany, D. Scott, T. Dodman & D. Stroud (eds.): *An Atlas of Wader Populations in Africa and Western Eurasia*. Wetlands International, Wageningen, pp. 291-297.
- Shamoun-Baranes, J., van Loon, E., Alon, D., Alpert, P., Yom-Tov, Y. & Leshem, Y. 2006. Is there a connection between weather at departure sites, onset of migration and timing of soaring-bird autumn migration in Israel? *Global Ecology and Biogeography* 15, 541-552.
- Shamoun-Baranes, J., Leyrer, J., van Loon, E., Bocher, P., Robin, F., Meunier, F. and Piersma, T. 2010. Stochastic atmospheric assistance and the use of emergency staging by migrants. *Proc. R. Soc. B*, 277, 1505-1511.
- Shannon, H. D., Young, G. S., Yates, M. A., Fuller, M. R., Seegar, W. S. 2002. American white pelican soaring flight times and altitudes relative to changes in thermal depth and intensity. *Condor* 104:679-683.
- Spaar, R., Bruderer, B. 2000. Soaring migration of steppe eagles *Aquila nipalensis* in southern Israel: flight behavior under various wind and thermal conditions. *Journal of Avian Biology* 27:289-301.
- Sinelschikova, A., Kosarev, V., Panov, I. and Baushev, A.N. 2010. The influence of wind conditions in Europe on the advance in timing of the spring migration of the song thrush (*Turdus philomelos*) in the south-east Baltic region. *International Journal of Biometeorology*, 51, 431-440.

- Skov 2010: Skånes Ornitologiska Förening (SkOF)
(unpubl. http://www.skof.se/fbo/index_e.html). Data from Falsterbo
(accessed on October 26, 2010).
- Skov, H., Christensen, K. D., Jacobsen, E. M., Meissner, J., Durinck, J. 1998. Fehmarn Belt feasibility study coast-to-coast investigations on environmental impact. Birds and marine mammals baseline investigations. Technical Note, Phase 2. Report No 27774C-E-N11-1, COWI-Lahmeyer Joint Venture, DK. 70 p.
- Skov, H., Heinänen, S., Žydelis, R., Bellebaum, J., Bzoma, S., Dagys, M., Durinck, J., Garthe, S., Grishanov, G., Hario, M., Kieckbusch, J. J., Kube, J., Kuresoo, A., Larsson, K., Luigujoe, L., Meissner, W., Nehls, H. W., Nilsson, L., Petersen, I.K., Roos, M. M., Pihl, S., Sonntag, N., Stock, A. and Stipniece, A. (in press). Waterbird populations and pressures in the Baltic Sea.
- Skov, H., Jensen, N.E., Durinck, J., Jensen, B.P. and Leonhard, S. 2008. Rødsand 2 land migration. Baseline autumn 2008. DHI report to E.ON.
- Spurr, E. and Milne, H. 1976. Adaptive significance of autumn pair formation in the Common Eider *Somateria mollissima* (L.). *Ornis Scandinavica*, 7, 85-89.
- Stahl, B. and Nehls, G. 2004. Offshore-Bürger-Windpark Butendiek – Fachgutachten Vogelzug. Endbericht nach Abschluss des zweiten Untersuchungsjahres (2002-2003). BioConsult SH report.
- Strandberg, R., Alerstam, T., Hake, M. and Kjellén, N. 2009a. Short-distance migration of the Common Buzzard *Buteo buteo* recorded by satellite tracking. *Ibis*, 151, 200–206.
- Strandberg, R., Klaassen, R. and Thorup, K. 2009b. Spatio-temporal distribution of migrating raptors: a comparison of ringing and satellite tracking. *J. Avian Biol.* 40, 500-510.
- Swennen, C. 1990. Dispersal and migratory movements of Eiders *Somateria mollissima* breeding in the Netherlands. *Ornis Scandinavica*, 21, 17–27.
- Thomas, L., Laake, J.L., Strindberg, S., Marques, F.F.C., Buckland, S.T., Borchers, D.L., Anderson, D.R., Burnham, K.P., Hedley, S.L., Pollard, J.H., Bishop, J.R.B. and Marques, T.A. 2006. Distance 5.0. Release "1". Research Unit for Wildlife Population Assessment, University of St. Andrews, UK. <http://www.ruwpa.st-and.ac.uk/distance/>
- Thorup, K., Alerstam, T., Hake, M., Kjellen, N. 2006. Traveling or stopping of migrating birds in relation to wind: An illustration for the osprey. *Behavioural Ecology* 17:497–502.
- Tiedemann, R. and Noer, H. 1998. Geographic partitioning of mitochondrial DNA patterns in European Eider *Somateria mollissima*. - *Hereditas* 128: 159-166.
- Tiedemann, R., Paulus, K.B., Scheer, M., Von Kistowski, K.G., Skírnisson, K., Bloch, D. and Dam, M. 2004. Mitochondrial DNA and microsatellite variation in the eider duck (*Somateria mollissima*) indicate stepwise postglacial colonization of Europe and limited current long-distance dispersal. *Molecular Ecology*, 13, 1481–1494.
- Trösch, B., R. Lardelli, F. Liechti, D. Peter, B. Bruderer 2005. Spatial and seasonal variation in nocturnal autumn and spring migration patterns in the western Mediterranean area: a moon-watching survey. *Avocetta* 29: 63-73.
- Tøttrup, A.P., Thorup, K. and Rahbek, C. 2006. Patterns of change in timing of spring migration in North European songbird populations. *J. Avian Biol.*, 37, 84-92.
- Videler, J. J. 2005. Avian flight. Oxford University Press.

FEHMARNBELT BIRDS

- Wetlands International 2006. Waterbird Population Estimates - Fourth Edition. Wetlands International, Wageningen, The Netherlands. 240 p.
- Wuczyński, A. 2003. Abundance of Common Buzzard (*Buteo buteo*) in the Central European wintering ground in relation to the weather conditions and food supply. BUTEO, 13, 11-20.
- Zaugg, S., Sapporta, G., van Loon, E., Schmaljohann, H. and Liechti, F. 2008. Automatic identification of bird targets with radar via patterns produced by wing flapping. J. Royal Soc., 5, 1041-1053.
- Zehnder S., Karlsson L. 2001. Do ringing numbers reflect true migratory activity of nocturnal migrants? Journal of Ornithology 142: 173-183.
- Zink, G. 1975. Der Zug europäischer Singvögel. Ein Atlas der Wiederfunde beringter Vögel Vol. 2 (Vogelzug, Möggingen).

FEHMARNBELT BIRDS

Table of figures

Figure 1.1	Schematic migration routes of waterbirds across the Fehmarnbelt Region. Red solid lines: waterbird species preferring to fly over water; dashed red lines: waterbirds preferring to fly over water, but crossing land in order to avoid large detours; green solid line: geese, ducks, waders with less pronounced preferences to fly over water.....	2
Figure 1.2	Daytime visual observations at Puttgarden onshore station: flight directions of Common Eider in spring (left) and autumn (right); results given in %.....	5
Figure 1.3	Daytime visual observations at Rødbyhavn onshore station: flight directions of Common Eider in spring (left) and autumn (right); results given in %.....	5
Figure 1.4	Daytime visual observations at Puttgarden onshore station (top) and Rødbyhavn onshore station (bottom): flight altitudes of Common Eider in spring (left) and autumn (right) 2009 and 2010.....	6
Figure 1.5	Number of night calls of Common Scoter in 2010 at Lolland (LL, harbour and inland) and Fehmarn (FM, harbour and inland). Total sums per night.....	9
Figure 1.6	Daytime visual observations at Puttgarden onshore station: flight directions of Common Scoter in spring (left) and autumn (right); results given in %.....	10
Figure 1.7	Daytime visual observations at Rødbyhavn onshore station: flight directions of Common Scoter in spring (left) and autumn (right); results given in %.....	10
Figure 1.8	Daytime visual observations at Puttgarden onshore station (top) and Rødbyhavn onshore station (bottom): flight altitudes of Common Scoter in spring (left) and autumn (right) 2009 and 2010.....	11
Figure 1.9	Flight paths of one satellite-tagged Common Scoter during September 6, 2010, time in UTC. The flight between 09:25h to 10:38h occurs daytime over land.	12
Figure 1.10	Evening/night flight of one satellite-tagged Common Scoter, 3 September 2010 across water. Time is UTC. Civil twilights are 17:32 and 01:27. Four days after this flight the bird was located at the western part of Gulf of Finland, Baltic Sea.....	13
Figure 1.11	Daytime visual observations at Puttgarden (top) and Rødbyhavn (bottom) onshore station: flight directions of divers in spring (left) and autumn (right); results given in %.....	15
Figure 1.12	Daytime visual observations at Puttgarden (top) and Rødbyhavn (bottom) onshore station: flight directions of auks in spring (left) and autumn (right); results given in %.....	16
Figure 1.13	Daytime visual observations at Puttgarden onshore station (top) and Rødbyhavn onshore station (bottom): flight altitudes of diver in spring (left) and autumn (right) 2009 and 2010.....	17
Figure 1.14	Daytime visual observations at Puttgarden onshore station (top) and Rødbyhavn onshore station (bottom): flight altitudes of auks in spring (left) and autumn (right) 2009 and 2010.....	18
Figure 1.15	Daytime visual observations at Puttgarden (top) and Rødbyhavn (bottom) onshore station: flight directions of swans in spring (left) and autumn (right); results given in %.....	20

FEHMARNBELT BIRDS

Figure 1.16	Daytime visual observations at Puttgarden onshore station (top) and Rødbyhavn onshore station (bottom): flight altitudes of swans in spring (left) and autumn (right) 2009 and 2010.	21
Figure 1.17	Daytime visual observations at Puttgarden onshore station: flight directions of Barnacle Goose in spring (left) and autumn (right); results given in %.	23
Figure 1.18	Daytime visual observations at Rødbyhavn onshore station: flight directions of Barnacle Goose in spring (left) and autumn (right); results given in %.	23
Figure 1.19	Daytime visual observations at Puttgarden onshore station (top) and Rødbyhavn onshore station (bottom): flight altitudes of Barnacle Goose in spring (left) and autumn (right) 2009 and 2010.	24
Figure 1.20	Daytime visual observations at Puttgarden onshore station: flight directions of waders in spring (left) and autumn (right); results given in %.	25
Figure 1.21	Daytime visual observations at Rødbyhavn onshore station: flight directions of waders in spring (left) and autumn (right); results given in %.	25
Figure 1.22	Daytime visual observations at Puttgarden onshore station (top) and Rødbyhavn onshore station (bottom): flight altitudes of waders in spring (left) and autumn (right) 2009 and 2010.	26
Figure 1.23	Daytime visual observations at Puttgarden onshore station: flight directions of Little Gull in spring (left) and autumn (right); results given in %.	27
Figure 1.24	Daytime visual observations at Rødbyhavn onshore station: flight directions of Little Gull in spring (left) and autumn (right); results given in %.	27
Figure 1.25	Daytime visual observations at Puttgarden onshore station (top) and Rødbyhavn onshore station (bottom): flight altitudes of Little Gull in spring (left) and autumn (right) 2009 and 2010.	28
Figure 1.26	Schematic migration routes of landbirds in the western Baltic Sea. Red dashed lines / arrows: migration routes across Belts and Sunds representing landbird daytime migration using shortest distances over water. Green solid lines and shaded areas: migration routes showing variability in location and direction and representing broad-front migration predominantly during night-time.	29
Figure 1.27	Daytime visual observations at Puttgarden onshore station: flight directions of Common Buzzard in spring (left) and autumn (right); results given in %.	33
Figure 1.28	Daytime visual observations at Rødbyhavn onshore station: flight directions of Common Buzzard in spring (left) and autumn (right); results given in %.	33
Figure 1.29	Daytime visual observations at Puttgarden onshore station: flight directions of Honey Buzzard in spring (left) and autumn (right); results given in %.	34
Figure 1.30	Daytime visual observations at Rødbyhavn onshore station: flight directions of Honey Buzzard in spring (left) and autumn (right); results given in %.	34
Figure 1.31	Daytime visual observations at Puttgarden onshore station: flight directions of Sparrowhawk in spring (left) and autumn (right); results given in %.	34

FEHMARNBELT BIRDS

Figure 1.32	Daytime visual observations at Rødbyhavn onshore station: flight directions of Sparrowhawk in spring (left) and autumn (right); results given in %.....	35
Figure 1.33	Daytime visual observations at Puttgarden onshore station (top) and Rødbyhavn onshore station (bottom): flight altitudes of Common Buzzard in spring (left) and autumn (right) 2009 and 2010.	35
Figure 1.34	Daytime visual observations at Puttgarden onshore station (top) and Rødbyhavn onshore station (bottom): flight altitudes of Honey Buzzard in spring (left) and autumn (right) 2009 and 2010.....	36
Figure 1.35	Daytime visual observations at Puttgarden onshore station (top) and Rødbyhavn onshore station (bottom): flight altitudes of Sparrowhawk in spring (left) and autumn (right) 2009 and 2010.....	36
Figure 1.36	Daytime visual observations at Puttgarden onshore station: flight directions of Fringilla finches in spring (left) and autumn (right); results given in %. No data for 2009 autumn available.....	40
Figure 1.37	Daytime visual observations at Rødbyhavn onshore station: flight directions of Fringilla finches in spring (left) and autumn (right); results given in %.....	40
Figure 1.38	Daytime visual observations at Puttgarden onshore station (top) and Rødbyhavn onshore station (bottom): flight altitudes of Fringilla finches in spring (left) and autumn (right) 2009 and 2010.No data for Puttgarden 2009 autumn available.....	42
Figure 3.1	Overview of the field stations 2009/2010 with horizontal (blue circle) and vertical radar (green rectangle) ranges. Stations with a red star were manned. Onshore red stars show the inland acoustic stations used in addition to the harbour acoustic stations. At the NW tip of Fehmarn, only a vertical radar was installed.	50
Figure 3.2	Field station Puttgarden with dual radar, clutter fence and trailer.....	51
Figure 3.3	Field station Rødbyhavn with dual radar and clutter fence mounted on the roof, trailer and weather station.	52
Figure 3.4	Field station Rødbyhavn; inside trailer with radar screen and working computer.	53
Figure 3.5	Field station Rødbyhavn with Pencil beam radar (Superfledermaus) and Scandlines ferry.	53
Figure 3.6	Arne Tiselius used for offshore observations, here with horizontal radar on front end (in Rødbyhavn).	54
Figure 3.7	Main anchor positions (AP) used for offshore observations. AP Central = offshore Fehmarnbelt, AP Hyllekrog = offshore Hyllekrog position.	55
Figure 3.8	Parabolic dish with microphone inside.....	56
Figure 3.9	Morning census transect (yellow line) at the station Rødbyhavn.....	57
Figure 3.10	Morning census transect (red line) at the station Puttgarden, from March 16 to April 10, 2009.	58
Figure 3.11	Morning census transect (red line) at the station Puttgarden, from April 11 to May 29, 2009.	58

FEHMARNBELT BIRDS

Figure 3.12	The radar operator searches birds on the screen and assigns them to the radar for tracking.	61
Figure 3.13	The observer on the radar tower identifies birds flying in the radar beam with the telescope mounted parallel to the axis of the beam.	61
Figure 3.14	Weather station used on land stations, mounted on the roof of field station trailer.	62
Figure 3.15	Detection of all tracks with a range of 6 km in Puttgarden and in Rødbyhavn spring 2010 compared to the track detection offshore (entire 2010). The plot shows mean (+- 95% confidence intervals) number of tracks per distance category from radar. Sample sizes: Puttgarden: 41,602. Rødbyhavn: 47,140 and offshore 6,827.....	65
Figure 3.16	Estimated surveyed air volume by the horizontal surveillance radar depending on distance to the radar applying an opening angle of 10°. The estimate assumes equal species-specific radar cross sections.....	66
Figure 3.17	The number of recorded tracks with 6 km range at Puttgarden during spring and autumn 2010, and the outline of the clutter-free range used for analyses of the geography of local migration.	68
Figure 3.18	Detection of all tracks with a range of 1500 m in Puttgarden and in Rødbyhavn spring 2010 compared to the track detection offshore (entire 2010). The plot shows mean (+- 95% confidence intervals) number of tracks per distance category from radar. Sample sizes: Puttgarden: 17,118. Rødbyhavn: 12,553 and offshore 2,140.....	68
Figure 3.19	Detection of all tracks with a range of 6 km in Puttgarden and in Rødbyhavn autumn 2010 compared to the track detection offshore (entire 2010). The plot shows mean (+- 95% confidence intervals) number of tracks per distance category from radar. Sample sizes: Puttgarden: 35,298. Rødbyhavn: 57,201 and offshore 6,827.....	69
Figure 3.20	Detection of all tracks with a range of 1500 m in Puttgarden and in Rødbyhavn autumn 2010 compared to the track detection offshore (entire 2010). The plot shows mean (+- 95% confidence intervals) number of tracks per distance category from radar. Sample sizes: Puttgarden: 17,625. Rødbyhavn: 15,758 and offshore 2,140.....	70
Figure 3.21	The number of tracks recorded at Rødbyhavn during spring and autumn 2010, and the outline of the clutter-free range used for analyses of the profiles of tracks densities. ...	71
Figure 3.22	The number of tracks recorded at the offshore station during spring and autumn 2010, and the outline of the clutter-free range used for analyses of the geography of local migration. Here, the map is relative to the ship not considering geographical coordinates, to show where the blanking sector is in relation to the ship.	71
Figure 3.23	Screenshot of "BirdTracker" view with radar screen as background image on the left and editing sheet on the right. Here, one active and two inactive tracks are shown.	73
Figure 4.1	Spring 2009 (upper chart) and 2010 (lower chart): Daytime visual observations at Puttgarden onshore station: migration intensity per day in ind./h counted during daytime; days covered with observations are indicated in grey on the upper axis.	103
Figure 4.2	Summer and autumn 2009 (upper chart) and 2010 (lower chart): Daytime visual observations at Puttgarden onshore station: migration intensity per day in ind./h; days covered with observations are indicated in grey on the upper axis.	104

FEHMARNBELT BIRDS

Figure 4.3	Spring night-time acoustic observations at Puttgarden harbour station 2009 (top) and 2010 (middle) and 2010 at the inland station (bottom): migration intensity per night in calls/h; nights covered with observations are indicated in grey on the upper axis.	105
Figure 4.4	Summer / autumn 2009 (upper two charts) and 2010 (lower two charts): Night-time acoustic observations at Puttgarden harbour and inland station: migration intensity per night in calls/h; nights covered with observations are indicated in grey on the upper axis.....	106
Figure 4.5	Spring 2009 (upper chart) and 2010 (lower chart): Daytime visual observations at Rødbyhavn onshore station: migration intensity per day in ind./h; days covered with observations are indicated in grey on the upper axis.	108
Figure 4.6	Summer and autumn 2009 (upper chart) and 2010 (lower chart): Daytime visual observations at Rødbyhavn onshore station: migration intensity per day in ind./h; days covered with observations are indicated in grey on the upper axis.	109
Figure 4.7	Spring night-time acoustic observations at Rødbyhavn harbour station 2009 (top) and 2010 (middle) and 2010 at the inland station (bottom): migration intensity per night in calls/h; nights covered with observations are indicated in grey on the upper axis.	110
Figure 4.8	Summer and autumn 2009 (upper two) and 2010 (lower two): Night-time acoustic observations at Rødbyhavn harbour and inland station: migration intensity per night in calls/h; nights covered with observations are indicated in grey on the upper axis.	111
Figure 4.9	Spring daytime visual observations at the Fehmarnbelt offshore station in 2009 (upper chart) and 2010 (lower chart): migration intensity per day in ind./h. Scale of the y-axis is 1,000 compared to 5,000 at the onshore locations; days covered with observations are indicated in grey on the upper axis.	113
Figure 4.10	Summer and autumn daytime visual observations at the Fehmarnbelt offshore station in 2009 (upper chart) and 2010 (lower chart): migration intensity per day in ind./h. Scale of the y-axis is 1,000 compared to 5,000 at the onshore locations; days covered with observations are indicated in grey on the upper axis.	114
Figure 4.11	Spring 2009 (upper chart) and 2010 (lower chart): Night-time acoustic observations at Fehmarnbelt offshore station. Migration intensity per night in calls/h counted during night-time; nights covered with observations are indicated in grey on the upper axis.	115
Figure 4.12	Autumn 2009 (upper chart) and 2010 (lower chart): Night-time acoustic observations at Fehmarnbelt offshore station. Migration intensity per night in calls/h counted during night-time; nights covered with observations are indicated in grey on the upper axis.	116
Figure 4.13	Night-time migration intensities as measured by surveillance radars at Lolland, offshore Fehmarnbelt, Fehmarn Puttgarden and Fehmarn Westermarkedorf (from top to bottom) in 2010. Coverage at the offshore station (top chart) limited to ship trips; inactive periods at other stations due to technical failure are too small to be pointed out.	119
Figure 4.14	Night-time migration intensities as measured by fixed pencil beam radar at Fehmarn Puttgarden in 2010. Fixed pencil beam has been inactive June 17 to August 14.....	120

FEHMARNBELT BIRDS

Figure 4.15	Seasonal dynamics of spring migration measured by fixed beam radar mode, daily sums of MTR of all elevations of the radar beam, all echoes, sea and land transects, spring 2009.	122
Figure 4.16	Seasonal dynamics of autumn migration measured by fixed beam radar mode, daily sums of MTR of all elevations of the radar beams and all altitudes, land and sea transect, autumn 2009.	123
Figure 4.17	Daytime visual observations at Puttgarden onshore station: flight directions of all species in spring and autumn 2009 (top) and 2010 (bottom); results given in %.....	127
Figure 4.18	Daytime visual observations at Puttgarden onshore station: flight directions of all waterbirds (green shaded area) separated analysed from all other species (bold lime line) in spring and autumn 2009 (top) and 2010 (bottom); results given in %, different scales for spring and autumn.....	128
Figure 4.19	Daytime visual observations at Puttgarden onshore station: flight directions of passerines (green shaded area) and pigeons (bold lime line) in spring and autumn 2009 (top) and 2010 (bottom); results given in %, different scales for spring and autumn.	129
Figure 4.20	Daytime visual observations at Puttgarden onshore station: flight directions of birds of prey (green shaded area) and geese (bold lime line) in spring and autumn 2009 (top) and 2010 (bottom); results given in %, different scales for spring and autumn.....	130
Figure 4.21	Daytime visual observations at Rødbyhavn onshore station: flight directions of all birds in spring and autumn 2009 (top) and 2010 (bottom); results given in %, different scales for spring and autumn.....	131
Figure 4.22	Daytime visual observations at Rødbyhavn onshore station: flight directions of all waterbirds (green shaded area) compared to all other species (bold lime line) in spring and autumn 2009 (top) and 2010 (bottom); results given in %, different scales for spring and autumn.	132
Figure 4.23	Daytime visual observations at Rødbyhavn onshore station: flight directions of passerines (green shaded area) and pigeons (bold lime line) in spring and autumn 2009 (top) and 2010 (bottom); results given in %.	133
Figure 4.24	Daytime visual observations at Rødbyhavn onshore station: flight directions of birds of prey (green shaded area) and geese (bold lime line) in spring and autumn 2009 (top) and 2010 (bottom); results given in %.	134
Figure 4.25	Daytime visual observations at Fehmarnbelt offshore: flight directions of "all birds" in spring and autumn 2009 (top) and 2010 (bottom); results given in %.	135
Figure 4.26	Daytime visual observations at Fehmarnbelt offshore of all waterbirds (green shaded area) and others (bold lime line) in spring and autumn 2009 (top) and 2010 (bottom); results given in %.	136
Figure 4.27	Daytime visual observations at Fehmarnbelt offshore of passerines (green shaded area) and pigeons (bold lime line; no data for 2010) in spring and autumn 2009 (top) and 2010 (bottom); results given in %.	137

FEHMARNBELT BIRDS

Figure 4.28	Daytime visual observations at Puttgarden onshore station: flight directions of birds of prey (green shaded area) and geese (bold lime line) in spring and autumn 2009 (top) and 2010 (bottom); results given in %, different scales for spring and autumn.	138
Figure 4.29	Daytime visual observations at Hyllekrog offshore during autumn 2009 of all birds (top left), all waterbirds and others (top right), passerines and pigeons (bottom left) and birds of prey and geese (bottom right); results given in %, different scales.	139
Figure 4.30	Tracks of type 1 species Common Scoter in spring (a, b, c) and Common Eider in autumn (d, e, f) at the Lolland coast (a, d), offshore (b, e) and Fehmarn coast (c, f). Red asterisk indicates position of the radar stations (offshore: ship position).....	143
Figure 4.31	Flight directions of type 1 species Common Scoter in spring (a, b, c) and Common Eider in autumn (d, e, f) at the Lolland coast (a, d), offshore (b, e) and Fehmarn coast (c, f). (For values see Table 4.19).....	144
Figure 4.32	Tracks of type 3 species Honey Buzzard in spring (a, b, c) and Wood Pigeon in autumn (d, e, f) at the Lolland coast (a,d), offshore (b, e) and Fehmarn coast (c, f). Red asterisk indicates position of the radar stations (offshore: ship position).	146
Figure 4.33	Flight directions of type 3 species Honey Buzzard in spring (a, b, c) and Wood Pigeon in autumn (d and f, no data for offshore) at the Lolland coast (a,d), offshore (b) and Fehmarn coast (c, f). (For values see Table 4.19).	147
Figure 4.34	Tracks of Branta species (Barnacle and Brent Goose) in spring (a, b, c) and Barnacle Goose in autumn (d, e, f) at the Lolland coast (a, d), offshore (b, e) and Fehmarn coast (c, f). Red asterisk indicates position of the radar stations (offshore: ship position)...	149
Figure 4.35	Main flight direction of Branta species (Barnacle and Brent Goose) in spring (a, b, c) and Barnacle Goose in autumn (d, e, f) at the Lolland coast (a, d), offshore (b, e) and Fehmarn coast (c, f).....	150
Figure 4.36	Influence of offshore structures, in this case a drilling platform, within the Common Eider migration route near to Puttgarden in September (a) and October (b) 2010. Yellow asterisk indicates position of the drilling platform.....	151
Figure 4.37	Diver flight paths without (a) and with influence of offshore structures, in this case the survey ship "Arne Tiselius" (b). Yellow asterisk indicates position of "Arne Tiselius"...	152
Figure 4.38	Example of flight tracks analysed from horizontal radar screenshots, here nocturnal migration from Puttgarden April 2010 (n=5,699). Flight directions are colour-coded to illustrate the dominance of birds flying north and northeast. Southeast directions over the sea probably represent waterbirds.....	158
Figure 4.39	Puttgarden autumn 2009 (October 2009), daytime: Track directions for coasting and crossing tracks averaged per km ² ; data from horizontal radar screenshots with 6 km range(n=6,940). The length of the vectors indicates the average length of tracks at each pixel. The green shading indicates directional variance at each pixel.	159
Figure 4.40	A summary of the flight directions daytime at Puttgarden during autumn 2009 with 6 km range.....	160
Figure 4.41	A summary of the flight directions daytime at Puttgarden during autumn 2010.....	160

FEHMARNBELT BIRDS

Figure 4.42	Puttgarden autumn 2010 (October 2010), night-time: Track directions for coasting and crossing tracks averaged per km ² ; data from horizontal radar screenshots with 6 km range (n=5,702). The length of the vectors indicates the average length of tracks at each pixel. The green shading indicates directional variance at each pixel.	161
Figure 4.43	Summary of the flight directions during night-time at Puttgarden autumn 2009. Range is 6 km.	161
Figure 4.44	Summary of the flight directions during night-time at Puttgarden autumn 2010.....	162
Figure 4.45	Puttgarden spring 2010 (April 2010), daytime: Track directions for coasting and crossing tracks averaged per km ² ; data from horizontal radar screenshots with 6 km range (n=9,402). The length of the vectors indicates the average length of tracks at each pixel. The green shading indicates directional variance at each pixel.	162
Figure 4.46	A summary of the flight directions daytime at Puttgarden during spring 2010.....	163
Figure 4.47	Summary of the flight directions during night-time at Puttgarden spring 2010.....	163
Figure 4.48	Rødbyhavn, autumn 2010 (October 2010), daytime: Track directions for coasting and crossing tracks averaged per km ² ; data from horizontal radar screenshots with 6 km range (n=14,854). The length of the vectors indicates the average length of tracks at each pixel. The green shading indicates directional variance at each pixel.	164
Figure 4.49	A summary of the flight directions daytime at Rødbyhavn during autumn 2009.	165
Figure 4.50	A summary of the flight directions daytime at Rødbyhavn during autumn 2010.	165
Figure 4.51	A summary of the flight directions night-time at Rødbyhavn during autumn 2009.	166
Figure 4.52	A summary of the flight directions night-time at Rødbyhavn during autumn 2010.	166
Figure 4.53	Summary of flight directions during daytime at Rødbyhavn spring 2010.	167
Figure 4.54	Summary of flight directions during night-time at Rødbyhavn spring 2010.	167
Figure 4.55	Summary of flight directions during daytime Offshore autumn 2010.....	168
Figure 4.56	Summary of flight directions during night-time Offshore autumn 2010.	168
Figure 4.57	Summary of flight directions during daytime Offshore spring 2010.....	169
Figure 4.58	Summary of flight directions during night-time Offshore spring 2010.....	169
Figure 4.59	Recorded diurnal migration intensities of waterbird-like tracks at different distances from the coast at Rødbyhavn during autumn 2009 and 2010 and spring 2010. The migration intensities represent the mean number of tracks recorded within 250x250 m grid cells. Only grid cells located within the clutter-free range of high detectability (Figure 3.21) have been extracted.	170
Figure 4.60	Recorded diurnal migration intensities of waterbird-like tracks at different distances from the coast at Puttgarden during autumn 2009 and 2010 and spring 2010. The migration intensities represent the mean number of tracks recorded within 250x250 m grid cells. Only grid cells located within the clutter-free range of high detectability (Figure 3.16) have been extracted.	170

F E H M A R N B E L T B I R D S

Figure 4.61	Recorded diurnal migration intensities of landbird-like tracks at different distances from the alignment of a fixed link at Rødbyhavn during autumn 2009 and 2010 and spring 2010. The migration intensities represent the mean number of tracks recorded within 250x250 m grid cells. Only grid cells located within the clutter-free range of high detectability east of the alignment (Figure 3.21) have been extracted.	171
Figure 4.62	Recorded diurnal migration intensities of landbird-like tracks at different distances from the alignment of a fixed link at Puttgarden during autumn 2009 and 2010 and spring 2010. The migration intensities represent the mean number of tracks recorded within 250x250 m grid cells. Only grid cells located within the clutter-free range of high detectability east of the alignment (Figure 3.15) have been extracted.	171
Figure 4.63	Recorded nocturnal migration intensities of landbird-like tracks at different distances from the alignment of a fixed link at Rødbyhavn during autumn 2009 and 2010 and spring 2010. The migration intensities represent the mean number of tracks recorded within 250x250 m grid cells. Only grid cells located within the clutter-free range of high detectability east of the alignment (Figure 3.21) have been extracted.	172
Figure 4.64	Recorded nocturnal migration intensities of landbird-like tracks at different distances from the alignment of a fixed link at Puttgarden during autumn 2009 and 2010 and spring 2010. The migration intensities represent the mean number of tracks recorded within 250x250 m grid cells. Only grid cells located within the limited clutter-free range of high detectability east of the alignment (Figure 3.16) have been extracted.	172
Figure 4.65	Daytime visual observations at Puttgarden onshore station: flight altitudes of all birds in spring (left) and autumn (right) 2009 (top) and 2010 (bottom).	174
Figure 4.66	Daytime visual observations at Puttgarden onshore station: flight altitudes of all waterbird species (green bars) and other species (lime bars) in spring (left) and autumn (right) 2009 (top) and 2010 (bottom).	175
Figure 4.67	Daytime visual observations at Puttgarden onshore station: flight altitudes of passerines (purple bars) and pigeons (blue bars) in spring and autumn 2009 (left) and 2010 (right).	176
Figure 4.68	Daytime visual observations at Puttgarden onshore station: flight altitudes of birds of prey (green bars) and geese (lime bars) in spring (left) and autumn (right) 2009 (top) and 2010 (bottom).	177
Figure 4.69	Daytime visual observations at Rødbyhavn onshore station: flight altitudes of all birds in spring (left) and autumn (right) 2009 (top) and 2010 (bottom).	178
Figure 4.70	Daytime visual observations at Rødbyhavn onshore station: flight altitudes of all waterbird species (green bars) and other species (lime bars) in spring (left) and autumn (right) 2009 (top) and 2010 (bottom).	179
Figure 4.71	Daytime visual observations at Rødbyhavn onshore station: flight altitudes of passerines (green bars) and pigeons (lime bars) in spring (left) and autumn (right) 2009 (top) and 2010 (bottom).	180
Figure 4.72	Daytime visual observations at Rødbyhavn onshore station: flight altitudes of birds of prey (green bars) and geese (lime bars) in spring (left) and autumn (right) 2009 (top) and 2010 (bottom).	181

FEHMARNBELT BIRDS

Figure 4.73	Daytime visual observations at Fehmarnbelt offshore station: flight altitudes of all birds in spring (left) and autumn (right) 2009 (top) and 2010 (bottom).....	182
Figure 4.74	Daytime visual observations at Fehmarnbelt offshore station: flight altitudes of all waterbird species (green bars) and other species (lime bars) in spring (left) and autumn (right) 2009 (top) and 2010 (bottom).	183
Figure 4.75	Daytime visual observations at Fehmarnbelt offshore station: flight altitudes of birds of prey (green bars) and geese (lime bars) in spring (left) and autumn (right) 2009 (top) and 2010 (bottom).....	184
Figure 4.76	Daytime visual observations at Fehmarnbelt offshore station: flight altitudes of passerines (green bars) and pigeons (lime bars) in spring (left) and autumn (right) 2009 (top) and 2010 (bottom; no data on pigeons for 2010).....	185
Figure 4.77	Daytime visual observations at Hyllekrog offshore station in autumn 2009: flight altitudes of selected species groups: all species (upper left), waterbirds and other (landbird) species (upper right), birds of prey and geese (lower left), and passerines and pigeons (lower right).....	186
Figure 4.78	Spring 2009: height distribution of mean migratory traffic rate (MTR) of birds flying towards land (above) and over sea (below). Four time intervals are given - civil twilight at sunset (CSS) until midnight – midnight until civil twilight at sunrise (CSR) – CSR until noon – noon until CSS.	188
Figure 4.79	Spring 2009: height distribution of mean migratory traffic rate (MTR) of passerine-type (top) and wader-type (bottom) birds flying towards land.	189
Figure 4.80	Autumn 2009: height distribution of mean migratory traffic rate (MTR) of birds flying towards land (above) and over sea (below). Four time intervals are given - civil twilight at sunset (CSS) until midnight – midnight until civil twilight at sunrise (CSR) – CSR until noon – noon until CSS. Be aware of different scales on the X-axis.....	190
Figure 4.81	Autumn 2009: height distribution of mean migratory traffic rate (MTR) of passerine-type (top) and wader-type (bottom) birds flying towards land.	191
Figure 4.82	Altitude distributions measured by surveillance radar at four radar stations in spring 2010 – daytime. Days with high migration intensities (left) versus days with low migration intensities (right).....	193
Figure 4.83	Altitude distributions measured by surveillance radar at four radar stations in spring 2010 – night-time. Nights with high migration intensities (left) versus days with low migration intensities (right).....	194
Figure 4.84	Height distribution of mean migration traffic rate (MTR) of birds flying towards sea (above) and parallel to the coast (below). Four time periods are given - civil twilight at sunset (CSS) until midnight – midnight until civil twilight at sunrise (CSR) – CSR until noon – noon until CSS.	195
Figure 4.85	Height distribution of mean migration traffic rates (MTR) for the passerine-type (top) and wader-type (bottom) of birds flying towards the sea.	196

FEHMARNBELT BIRDS

Figure 4.86	Altitude distributions measured by surveillance radar at four radar stations in autumn 2010 – daytime. Days with high migration intensities (left) versus days with low migration intensities (right).....	197
Figure 4.87	Altitude distributions measured by surveillance radar at the four radar stations in autumn 2010 – night-time. Nights with high migration intensities (left) versus days with low migration intensities (right).....	198
Figure 4.88	Height distribution of mean migration traffic rate (MTR) of birds flying towards sea (above) and parallel to the coast (below). Four time periods are given - civil twilight at sunset (CSS) until midnight – midnight until civil twilight at sunrise (CSR) – CSR until noon – noon until CSS.....	199
Figure 4.89	Height distribution of mean migration traffic rates (MTR) for the passerine-type of birds (N=61,375) flying towards the sea.	200
Figure 4.90	Altitude distributions night-time measured by surveillance radar in Rødbyhavn (top), Puttgarden (middle) and Westermarkelsdorf (bottom) on April 5, 2010 (left) and April 6, 2010 (right).	201
Figure 4.91	Altitude distributions night-time measured by surveillance radar in Rødbyhavn, offshore Fehmarnbelt, Puttgarden and Westermarkelsdorf (from top to bottom) on April 24, 2010 (left) and April 25, 2010 (right).	202
Figure 4.92	Altitude distributions night-time measured by surveillance radar at Rødbyhavn (top), Puttgarden (middle) and Westermarkelsdorf (bottom) on October 8, 2010 (left) and October 10, 2010 (right).....	203
Figure 4.93	Spring 2009: Distribution of flight directions of nocturnal migrants in three height intervals: a) 0 to 200 m (n = 310); b) 201 and 500 m (n = 318); c) >500 m asl (n = 4,366). Data from tracking radar “Superfledermaus” were used.	205
Figure 4.94	Spring 2009: Distribution of flight directions of diurnal migrants in three height intervals: a) 0 to 200 m (n = 3,572); b) 201 and 500 m (n = 1,581); c) >500 m asl (n = 3,420). Data from tracking radar “Superfledermaus” were used.	206
Figure 4.95	Summer 2009: Distribution of flight directions of herons (a), ducks (b) and swifts (c). Species groups were identified based on thermal imaging and wingbeat pattern (n = 19, 68, 346). Data from tracking radar “Superfledermaus” were used.....	207
Figure 4.96	Autumn 2009: Distribution of flight directions of nocturnal migrants at three height intervals: a) 0 to 200 m (n = 257); b) 201 and 500 m (n = 277); c) >500 m asl (n = 1,956). Data from tracking radar “Superfledermaus” were used.	208
Figure 4.97	Autumn 2009: Distribution of flight directions of diurnal migrants in three height intervals: a) 0 to 200 m (n = 1,149); b) 201 to 500 m (n = 1,975); c) > 500 m asl (n = 1,513). Data from tracking radar “Superfledermaus” were used.	208
Figure 4.98	Spring 2010: Distribution of flight directions of nocturnal migrants at three height intervals: a) 0 to 200 m (N = 280); b) 201 and 500 m (N = 2481); c) >500 m asl (N = 5852). Data from tracking radar “Superfledermaus” were used.	209

FEHMARNBELT BIRDS

Figure 4.99	Spring 2010: Distribution of flight directions of diurnal migrants in three height intervals: a) 0 to 200 m (N = 183); b) 201 and 500 m (N = 1366); c) > 500 m asl (N = 3985). Data from tracking radar "Superfledermaus" were used.....	209
Figure 4.100	Autumn 2010: Distribution of flight directions of nocturnal migrants at three height intervals: a) 0 to 200 m (N = 104); b) 201 and 500 m (N = 900); c) >500 m asl (N = 3,354). Data from tracking radar "Superfledermaus" were used.....	210
Figure 4.101	Autumn 2010 :Distribution of flight directions of diurnal migrants in three height intervals: a) 0 to 200 m (N =200); b) 201 and 500 m (N = 1,125); c) > 500 m asl (N = 2,193). Data from tracking radar "Superfledermaus" were used.....	211
Figure 4.102	Tracks of Barnacle Goose, Rødbyhavn spring 2009, n=9. Data from tracking radar "Superfledermaus" were used.....	215
Figure 4.103	Dynamics of altitude change during the migratory flight in Barnacle Goose as recorded at Rødbyhavn during spring 2009 (n=9). The frequent small amplitudes of the track heights may be due to the 'Superfledermaus' switching targets within large flocks. Data from tracking radar "Superfledermaus" were used.	216
Figure 4.104	Tracks of Barnacle Goose, Rødbyhavn autumn 2009 (n=24). Data from tracking radar "Superfledermaus" were used.....	216
Figure 4.105	Dynamics of altitude change during the migratory flight in Barnacle Goose as recorded in Rødbyhavn in autumn 2009 (n=24). Data from tracking radar "Superfledermaus" were used.	217
Figure 4.106	Tracks of Honey Buzzard, Rødbyhavn spring 2009, n=40. Data from tracking radar "Superfledermaus" were used.....	218
Figure 4.107	Dynamics of altitude change during the migratory flight in Honey Buzzards as recorded at Rødbyhavn in spring 2009, n=40. Data from tracking radar "Superfledermaus" were used.....	218
Figure 4.108	Tracks of Honey Buzzards, Rødbyhavn autumn 2009, n=90. Data from tracking radar "Superfledermaus" were used.....	219
Figure 4.109	Dynamics of altitude change during the migratory flight in Honey Buzzards as recorded at Rødbyhavn in autumn 2009 (example of 13 longest tracks). Data from tracking radar "Superfledermaus" were used.....	219
Figure 4.110	Tracks of Marsh Harrier, Rødbyhavn spring 2009 (n=7). Data from tracking radar "Superfledermaus" were used.....	220
Figure 4.111	Dynamics of altitude change during the migratory flight in March Harrier as observed at Rødbyhavn in spring 2009, n=7. Data from tracking radar "Superfledermaus" were used.....	220
Figure 4.112	Tracks of Marsh Harriers, Rødbyhavn autumn 2009 (n=10). Data from tracking radar "Superfledermaus" were used.....	221
Figure 4.113	Dynamics of altitude change during the migratory flight in Marsh Harrier as observed at Rødbyhavn during autumn 2009 (n=10). Data from tracking radar "Superfledermaus" were used.....	221

FEHMARNBELT BIRDS

Figure 4.114	Tracks of Sparrowhawks, Rødbyhavn spring 2009 (n=73). Data from tracking radar "Superfledermaus" were used.	222
Figure 4.115	Dynamics of altitude change during the migratory flight in Sparrowhawk, arriving at Rødbyhavn in spring 2009 (n=73). Data from tracking radar "Superfledermaus" were used.....	222
Figure 4.116	Example of longest tracks of Sparrowhawks recorded at Rødbyhavn in autumn 2009 (n=24). Data from tracking radar "Superfledermaus" were used.....	223
Figure 4.117	Dynamics of altitude change during the migratory flight of Sparrowhawks (example of 8 longest tracks), autumn 2009. Data from tracking radar "Superfledermaus" were used.....	224
Figure 4.118	Tracks of Wood Pigeon, Rødbyhavn spring 2009, n=13. Data from tracking radar "Superfledermaus" were used.	225
Figure 4.119	Dynamics of altitude change during the migratory flight in Wood Pigeons as recorded at Rødbyhavn in spring 2009, n=13. Data from tracking radar "Superfledermaus" were used.....	225
Figure 4.120	Tracks of Wood Pigeons, Rødbyhavn autumn 2009 (n=84). Data from tracking radar "Superfledermaus" were used.	226
Figure 4.121	Dynamics of altitude change during the migratory flight of Wood Pigeons as recorded at Rødbyhavn during autumn 2009 (example of 10 longest tracks). Data from tracking radar "Superfledermaus" were used.	226
Figure 4.122	Tracks of Yellow Wagtails, Rødbyhavn autumn 2009 (n=9). Data from tracking radar "Superfledermaus" were used.	227
Figure 4.123	Dynamics of altitude change during the migratory flight in Yellow Wagtail, Rødbyhavn autumn 2009 (n=9). Data from tracking radar "Superfledermaus" were used.....	227
Figure 4.124	Tracks of Chaffinches, Rødbyhavn spring 2009 (n=12). Data from tracking radar "Superfledermaus" were used.	228
Figure 4.125	Dynamics of altitude change during the migratory flight of Chaffinches (n=12) as recorded in Rødbyhavn in spring 2009 (n=12). Data from tracking radar "Superfledermaus" were used.	228
Figure 4.126	Tracks of flocks of Chaffinches, Rødbyhavn autumn 2009 (n=3). Data from tracking radar "Superfledermaus" were used.	229
Figure 4.127	Dynamics of altitude change during the migratory flight in Chaffinch flocks as recorded at Rødbyhavn during autumn 2009 (example of 3 tracks). Data from tracking radar "Superfledermaus" were used.	229
Figure 4.128	Distribution of vertical speed during the autumn migration in Rødbyhavn in 2009 (n=235). Data from tracking radar "Superfledermaus" were used.	231
Figure 4.129	Flight altitude distribution in relation to the vertical speed of long tracks during autumn 2009 (n=235). Data from tracking radar "Superfledermaus" were used.....	232
Figure 4.130	Distribution of vertical speed in relation to the directions of the tracks during autumn 2009 (n=235). Data from tracking radar "Superfledermaus" were used.....	232

FEHMARNBELT BIRDS

Figure 4.131	Distribution of vertical speed in relation to ground wind direction during autumn 2009 (n=235). Data from tracking radar "Superfledermaus" were used.	232
Figure 4.132	Distribution of vertical speed during the autumn migration in Puttgarden in 2010 (n=2426). Data from tracking radar "Superfledermaus" were used.	233
Figure 4.133	Flight altitude distribution in relation to the vertical speed at Puttgarden in autumn 2010. Data from tracking radar "Superfledermaus" were used.	233
Figure 4.134	Distribution of vertical speed in relation to the directions of the tracks at Puttgarden during autumn 2010. Data from tracking radar "Superfledermaus" were used.	234
Figure 4.135	Distribution of vertical speed in relation to ground wind direction at Puttgarden in autumn 2010. Data from tracking radar "Superfledermaus" were used.	234
Figure 4.136	Mean vertical speed of the tracks in relation to ground wind direction, nocturnal manual tracks, autumn 2010 (data points with n less 20 tracks in a group were erased). Data from tracking radar "Superfledermaus" were used.	235
Figure 4.137	Mean vertical speed (V_z) in relation to the cloud cover, nocturnal tracks, autumn 2010, bars indicate SE. Data from tracking radar "Superfledermaus" were used.	236
Figure 4.138	Map of the nocturnal long tracks ascending with the vertical speed > 50 cm/sec as recorded at Rødbyhavn during autumn 2009 (n=61). Three red arrows indicate the three lowest tracks (altitude < 275 m), which are non-linear as compared to most other tracks at higher altitudes; red asterisk marks the position of the tracking radar in Rødbyhavn. Data from tracking radar "Superfledermaus" were used.	237
Figure 4.139	Dynamics of altitude change for tracks from Figure 4.138. Data from tracking radar "Superfledermaus" were used.	237
Figure 4.140	Dynamics of altitude change for the 3 tracks marked by red arrows in Figure 4.138 ascending and zigzagging at low elevations. Data from tracking radar "Superfledermaus" were used.	238
Figure 4.141	Relation between vertical speed and the altitude of the same tracks as shown in Figure 4.138. Data from tracking radar "Superfledermaus" were used.	238
Figure 4.142	Distribution of descending (< -50 cm/sec, left) and ascending (> 50 cm/sec, right) tracks around the radar at Puttgarden in autumn 2010. Axes are in meters. Axes are in [m], coordinate system is oriented N. Data from tracking radar "Superfledermaus" were used.	239
Figure 4.143	Relation between vertical speed and the altitude, night ascending tracks autumn 2010 (n= 599). Data from tracking radar "Superfledermaus" were used.	239
Figure 4.144	Map of descending night-time tracks with the vertical speed < -50 cm/sec as recorded at Rødbyhavn in autumn 2009 (n=38).	240
Figure 4.145	Dynamics of altitude change for descending tracks from Figure 4.144.	240
Figure 4.146	Relation between descending vertical speed and cloud cover as observed for long night-time tracks recorded at Rødbyhavn in autumn 2009 (n=38).	241
Figure 4.147	Relation between vertical speed and the altitude, night descending tracks, autumn 2010.	242

FEHMARNBELT BIRDS

Figure 5.1	Number of nocturnal calls of Barnacle Goose at Lolland onshore (LL_harbour), Lolland inland (LL_inland), Fehmarn onshore (FM_harbour), Fehmarn inland (FM_inland) and on the ship (offshore) in 2010.....	252
Figure 5.2	Weather conditions and the number of nocturnal calls per hour in 2009 and 2010 at all stations for Barnacle Goose.....	253
Figure 5.3	Number of nocturnal calls of Wigeon at Lolland onshore (LL_harbour), Lolland inland (LL_inland), Fehmarn onshore (FM_harbour), Fehmarn inland (FM_inland) and on the ship (offshore) in 2010.	254
Figure 5.4	Weather conditions and the number of nocturnal calls per hour in 2009 and 2010 at all stations for Wigeon.	255
Figure 5.5	Number of nocturnal calls of Eurasian Curlews at Lolland onshore (LL_harbour), Lolland inland (LL_inland), Fehmarn onshore (FM_harbour), Fehmarn inland (FM_inland) and on the ship (offshore) in 2010.....	256
Figure 5.6	Weather conditions and the number of nocturnal calls per hour in 2009 and 2010 at all stations for Eurasian Curlew.	257
Figure 5.7	Number of nocturnal calls of Skylark at Lolland onshore (LL_harbour), Lolland inland (LL_inland), Fehmarn onshore (FM_harbour), Fehmarn inland (FM_inland) and on the ship (offshore) in 2010.	258
Figure 5.8	Weather conditions and the number of nocturnal calls per hour in 2009 and 2010 at all stations for Skylark.	259
Figure 5.9	Number of nocturnal calls of Tree Pipit at Lolland onshore (LL_harbour), Lolland inland (LL_inland), Fehmarn onshore (FM_harbour), Fehmarn inland (FM_inland) and on the ship (offshore) in 2009.	260
Figure 5.10	Number of nocturnal calls of Tree Pipit at Lolland onshore (LL_harbour), Lolland inland (LL_inland), Fehmarn onshore (FM_harbour), Fehmarn inland (FM_inland) and on the ship (offshore) in 2010.	261
Figure 5.11	Weather conditions and the number of nocturnal calls per hour in 2009 and 2010 at all stations for Tree Pipit.	262
Figure 5.12	Number of nocturnal calls of Robin at Lolland onshore (LL_harbour), Lolland inland (LL_inland), Fehmarn onshore (FM_harbour), Fehmarn inland (FM_inland) and on the ship (offshore) in 2009.	263
Figure 5.13	Number of nocturnal calls of Robins at Lolland onshore (LL_harbour), Lolland inland (LL_inland), Fehmarn onshore (FM_harbour), Fehmarn inland (FM_inland) and on the ship (offshore) in 2010.	264
Figure 5.14	Weather conditions and the number of nocturnal calls per hour in 2009 and 2010 at all stations for Robin.....	265
Figure 5.15	Number of nocturnal calls of Blackbird at Lolland onshore (LL_harbour), Lolland inland (LL_inland), Fehmarn onshore (FM_harbour), Fehmarn inland (FM_inland) and on the ship (offshore) in 2010.	266

FEHMARNBELT BIRDS

Figure 5.16	Weather conditions and the number of nocturnal calls per hour in 2009 and 2010 at all stations for Blackbird.....	267
Figure 5.17	Number of nocturnal calls of Songthrush at Lolland onshore (LL_harbour), Lolland inland (LL_inland), Fehmarn onshore (FM_harbour), Fehmarn inland (FM_inland) and on the ship (offshore) in 2009.	268
Figure 5.18	Number of nocturnal calls of Songthrush at Lolland onshore (LL_harbour), Lolland inland (LL_inland), Fehmarn onshore (FM_harbour), Fehmarn inland (FM_inland) and on the ship (offshore) in 2010.	269
Figure 5.19	Weather conditions and the number of nocturnal calls per hour in 2009 and 2010 at all stations for Songthrush.	270
Figure 5.20	Annual phenologies of the short/medium distance migrants (black columns) and the long-distance migrants (grey columns) in the trapping garden on Helgoland from 1960 to 2008 (Hüppop and Hüppop 2011).	272
Figure 5.21	Left: Proposed Common Eider migration routes compared with the corresponding straight-line distance (dashed line); triangles represent capture sites of breeding adult females in Finland, and circles the recovery sites of these birds in winter in the Wadden Sea (Masden et al., 2009). Right: Wintering (cross-hatched) and breeding (hatched) area of Baltic population of the Common Eiders (Alerstam et al., 1974).	273
Figure 5.22	Examples of Eider migration in the area of Skåne, southern Sweden, as shown by radar and visual observations. From left to right: April 7, morning; April 13, morning; April 12, 19:00 - 22:00 h; April 14, 19:00 - 22:00 h (Alerstam et al., 1974).	274
Figure 5.23	The track of one Common Eider individual during April 18, 2009. Time (UTC) of positioning is shown at each location point (see text for details).	275
Figure 5.24	Seasonal dynamics of spring migration of Common Eider at Puttgarden (top) and Rødbyhavn (bottom). Days covered are indicated in grey on the upper axis.	276
Figure 5.25	Occurrence of three strongest spring migration peaks of Common Eiders at Puttgarden (blue lines) and Rødbyhavn (red lines) in relation to weather parameters. Blue triangle shows mean passage date on Fehmarn (OAG database).	277
Figure 5.26	Relation between wind direction and spring migration intensity of Common Eider at Fehmarn. Days with 90 % of total numbers are present, left - days with 60 % of birds (maximal peaks), right - the rest of days with weak migration. Inner circle shows the 95% confidence interval for the mean wind direction. The direction is significant when the arrow of mean direction is longer than inner circle showing the confidence interval.	278
Figure 5.27	Seasonal dynamics of autumn migration of Common Eider in at Falsterbo (average 2000-2009 and 2009; top), Puttgarden (middle) and Rødbyhavn (bottom). Days covered are indicated in grey on the upper axis.	279
Figure 5.28	Relationship between wind direction and migration intensity of Common Eider during autumn 2009 at Lolland (left) and Fehmarn (right). Intensities were grouped in the 10 degrees sector of wind direction; the length of the arrow represents the intensity of migration, arrow is pointed to where the wind is blowing from.	280

FEHMARNBELT BIRDS

Figure 5.29	Occurrence of migration peaks of Common Eiders in relation to weather parameters. Three days of peak migration selected for both Lolland (red lines) and Fehmarn (blue lines); green lines show peaks on both sides. Black triangle shows mean passage date on Falsterbo (10 years), blue triangle the median passage date on Fehmarn (10 years, OAG data).	281
Figure 5.30	Relation between wind direction and autumn 2009 migration intensity of Common Eider at Fehmarn. Days with 90 % of total numbers are presented, left – days with 60 % of birds (maximal peaks), right – the rest of days with weak migration. Directions in both cases are not significant.	282
Figure 5.31	Relation between migration intensity of the Common Eider at Lolland (upper charts) and Fehmarn (lower charts) in spring (left) and autumn (right) and wind direction, 2009-2010. Black line shows the mean direction of wind for the entire migration period, the arc at the end of it is black when the direction is significant and red when direction is non-significant. For details see Figure 5.31.	283
Figure 5.32	Migratory flyway of the Russian population of the Barnacle Goose <i>Branta leucopsis</i> , determined from ring recoveries (1965–2003) and results from satellite telemetry autumn 2004 - spring 2005 (Drent et al., 2007). PTT spring / fall – signals from satellite transmitter in spring and autumn, respectively.	284
Figure 5.33	Spring staging, stop-over and breeding sites of Barnacle Geese wintering in continental Europe. Blue lines show the migratory flyway between spring staging areas and stop-over sites at the Baltic Sea (from van der Graaf 2006, with modifications)	285
Figure 5.34	Dynamics of spring migration 2009 of Barnacle Goose at Puttgarden (top) and Rødbyhavn (bottom). Days covered are indicated in grey on the upper axis.	286
Figure 5.35	Occurrence of three strongest spring migration peaks of Barnacle Goose at Puttgarden (blue lines), Rødbyhavn (red lines) in relation to weather parameters, or both Puttgarden and Rødbyhavn (green line). Blue triangle shows mean passage date on Fehmarn (OAG database).	287
Figure 5.36	Wind direction and intensity of Barnacle Goose spring migration at Fehmarn (top) and Lolland (bottom); left - peak days, right – the rest of the days. Inner circle shows the 95% confidence interval for the mean wind direction. The direction is significant when the arrow of mean direction is longer than inner circle showing the confidence interval.	288
Figure 5.37	Map of wind conditions over Europe on May 6, 2009 6:00 UTC, a day before peak migration of Barnacle Goose, left - westerly (u) and right - southerly (v) wind components. Note the large area of strong WNW winds SW of Utland peninsular. Wind speed is represented by isolines connecting areas with the same values of speed. The Figure is produced online using NOAA site (see Methods).....	288
Figure 5.38	Dynamics of autumn migration 2009 of Barnacle Goose at Falsterbo (average 2000-2009 and 2009; top), Puttgarden (middle) and Rødbyhavn (bottom). Days covered are indicated in grey on the upper axis.	289

FEHMARNBELT BIRDS

Figure 5.39	Occurrence of three strongest autumn migration peaks of Barnacle Goose at Puttgarden (blue lines), Rødbyhavn (red lines) in relation to weather parameters, or both Puttgarden and Rødbyhavn (green line). Blue triangle shows mean passage date on Fehmarn (OAG database). Black triangle shows mean passage date at Falsterbo.	290
Figure 5.40	Wind direction and intensity of autumn migration of Barnacle Goose, left – Lolland, right – Fehmarn.	291
Figure 5.41	Intensity of nocturnal calls of Barnacle Goose at Lolland (LL), Fehmarn (FM) and offshore recording stations in 2010.	292
Figure 5.42	Relation between migration intensity of the Barnacle Goose in spring and autumn and wind direction, 2009-2010. For details see Figure 5.31.	293
Figure 5.43	Comparison of wintering areas of Common Buzzard identified by satellite telemetry and ringing recoveries, G – adults, H – juveniles; shaded zone indicates the latitudes never reached by tracked birds (from Strandberg et al., 2009b with modifications).....	295
Figure 5.44	Autumn migration tracks for female (A), male (B) and juvenile (C) Common Buzzards, recorded by satellite telemetry tracking. Stars indicate stop-overs made along tracks [for juveniles (C) the dispersal areas are also indicated by the star symbol; first stop-over along track]. Black dots indicate wintering area (from Strandberg et al., 2009a).	296
Figure 5.45	Dynamics of spring migration 2009 of Common Buzzard at Puttgarden (top) and Rødbyhavn (bottom). Days covered are indicated in grey on the upper axis.	297
Figure 5.46	Occurrence of three strongest spring migration peaks of Common Buzzard at Puttgarden (blue lines), Rødbyhavn (red lines) in relation to weather parameters, or both Puttgarden and Rødbyhavn (green line). Blue triangle shows mean passage date on Fehmarn (OAG database).....	298
Figure 5.47	Wind direction during selected days (blue dots) and mean direction of wind (arrow) of Common Buzzard spring migration on Fehmarn for migration days when 90 % of birds passed the Fehmarnbelt. Left – peak migration days, right – days with weak migration. Further details see Figure 5.36.	299
Figure 5.48	Wind direction during selected days (blue dots) and mean direction of wind (arrow) of Common Buzzard spring migration on Lolland during days when 90 % of birds passed the Fehmarnbelt. Left – peak migration days, right – days with weak migration. Further details see Figure 5.36.	299
Figure 5.49	Dynamics of autumn migration 2009 of Common Buzzard at Falsterbo (average 2000-2009 and 2009; top), Puttgarden (middle) and Rødbyhavn (bottom). Days covered are indicated in grey on the upper axis.....	300
Figure 5.50	Occurrence of the three strongest autumn migration peaks of Common Buzzard at Puttgarden (blue lines), Rødbyhavn (red lines) in relation to weather parameters, or both Puttgarden and Rødbyhavn (green line). Blue triangle shows mean passage date on Fehmarn (OAG database), black triangle shows the 10 years-mean passage dates at Falsterbo.	301

FEHMARNBELT BIRDS

Figure 5.51	Wind direction during selected days (blue dots) and mean direction of wind (arrow) of Common Buzzard autumn migration on Fehmarn during days when 90 % of birds passed the Fehmarnbelt. Left – strongest peak migration days, right – days with weak migration. Further details see Figure 5.26.	302
Figure 5.52	Wind direction during selected days (blue dots) and mean direction of wind (arrow) of Common Buzzard autumn migration on Lolland during the entire migratory season. Left – 16 peak migration days (mean wind direction is 317°, n.s.), right – days without migration (mean wind direction is 177°, p=0.018). Further details see Figure 5.26. ...	302
Figure 5.53	Relation between migration intensity of the Common Buzzard in spring and autumn and wind direction at Lolland (upper) and Fehmarn (lower) during spring (left) and autumn (right) , 2009-2010. For details see Figure 5.31.....	303
Figure 5.54	Relation between wind speed (horizontal axis [m/s]) and intensity of migration (vertical axis; lg of migration intensity in ind./h) of Common Buzzard in 2009–2010 at Lolland (upper) and Fehmarn (lower) during spring (left) and autumn (right).....	304
Figure 5.55	Relation between cloud altitude (horizontal axis, [m]) and intensity of migration (vertical axis; lg of migration intensity in ind./h) of Common Buzzard in 2009–2010 at Lolland (upper) and Fehmarn (lower) during spring (left) and autumn (right).....	304
Figure 5.56	Breeding (orange) and wintering (blue) areas of Honey Buzzard (Mebs and Schmidt 2006).....	305
Figure 5.57	Intensity of spring migration of Honey Buzzard in relation to wind direction (left – Fehmarn, right – Lolland). For details see Figure 5.28 and text above.	306
Figure 5.58	Intensity of autumn migration of Honey Buzzard in relation to wind direction (left – Fehmarn, right – Lolland). For details see Figure 5.28.	307
Figure 5.59	Dynamics of spring migration of Honey Buzzard at Puttgarden (top) and Rødbyhavn (bottom). Days covered with observations are indicated in grey on the upper axis. ...	308
Figure 5.60	Dynamics of autumn migration of Honey Buzzard at Falsterbo (average 2000-2009 and 2009; top), Puttgarden (middle) and Rødbyhavn (bottom). Days covered are indicated in grey on the upper axis.	309
Figure 5.61	Dynamics of autumn migration of Honey Buzzard (migration intensity in blue, right y-axis) in relation to wind direction (in red, left y-axis). Top: Fehmarn; bottom: Lolland.	310
Figure 5.62	Relation between migration intensity of the Honey Buzzard in spring and autumn and wind direction, 2009-2010. For details see Figure 5.31.	311
Figure 5.63	Relation between wind speed (horizontal axis [m/s]) and intensity of migration (vertical axis; lg of migration intensity in ind./h) of Honey Buzzard in 2009–2010 at Lolland (upper) and Fehmarn (lower) during spring (left) and autumn (right).....	312
Figure 5.64	Relation between visibility (horizontal axis [m]) and intensity of migration (vertical axis; lg of migration intensity in ind./h) of Honey Buzzard in 2009–2010 at Lolland (upper) and Fehmarn (lower) during spring (left) and autumn (right).	312

FEHMARNBELT BIRDS

Figure 5.65	Relation between temperature trend in previous 2 days (horizontal axis [degrees]) and intensity of migration (vertical axis; lg of migration intensity in ind./h) of Honey Buzzard in 2009–2010 at Lolland (upper) and Fehmarn (lower) during spring (left) and autumn (right).	313
Figure 5.66	Distribution of Tree Pipit. Red – breeding areas of the nominate species, light red of <i>Anthus trivialis haringtoni</i> , blue – wintering areas, light blue – passage areas (adapted after Beaman and Madge (1998)).	314
Figure 5.67	Dynamics of spring migration 2009 of Tree Pipit at Puttgarden (top) and Rødbyhavn (bottom). Days covered are indicated in grey on the upper axis.....	315
Figure 5.68	Relation between the intensity of Tree Pipit spring migration at Fehmarn and wind direction. The length of the arrows reflects the migration intensity, the direction of the arrows shows from where the wind is blowing. For details see Figure 5.31.	316
Figure 5.69	Dynamics of autumn migration of Tree Pipit at Falsterbo (average 2000-2009 and 2009; top) and Rødbyhavn (bottom). Data from Puttgarden are not shown as most values < 1 N/h. Days covered are indicated in grey on the upper axis.	317
Figure 5.70	Seasonal dynamics of intensity of nocturnal calls of Tree Pipit at Lolland in autumn...	318
Figure 5.71	Relation between the intensity of Tree Pipit autumn migration at Lolland and wind direction. The length of the arrows reflects the migration intensity, arrow pointed at the direction from where the wind is blowing. For details see Figure 5.31.	318
Figure 5.72	Intensity of nocturnal calls of Tree Pipits at Lolland (LL), Fehmarn (FM) and offshore recording stations in 2010.....	319
Figure 5.73	Relation between migration intensity of the Tree Pipit in spring and autumn and wind direction, 2009-2010. For details see Figure 5.31.....	320

List of tables

Table 1.1	Birds of prey species observed during visual observations 2009 and 2010 at land stations and reference numbers. Breeding populations (Mebs and Schmidt 2006); birds passing Gedser 1988 (Desholm 2009), Falsterbo autumn mean counts (Kjellen 2007), maximum numbers autumn Fehmarn coast (Koop 2003-2008). Reference numbers > overall totals of own studies: numbers in red.	31
Table 1.2	Most common Passerine species observed during visual observations at all observation stations in 2009 and 2010 and fraction of all observed birds.....	38
Table 3.1	Specifications of surveillance radar.....	59
Table 3.2	Parameters as estimated for the detections functions for each radar device using Distance (Thomas et al., 2006).....	64
Table 3.3	Bird migration direction and wind direction categories and corresponding angles.	75
Table 3.4	Field stations 2009 and 2010: operation periods, field days, effort for the different activities.	79

FEHMARNBELT BIRDS

Table 3.5	Swiss radar 'Superfledermaus' 2009 at Rødbyhavn, 2010 at Puttgarden: field days and effort for the different activities.	80
Table 3.6	Total number of analysed vertical screenshots (1.5 km range) at each station during each of the three investigated seasons.	80
Table 3.7	Total number of analysed horizontal screenshots (1.5 and 6.0 km range) at each station during each of the three investigated seasons.	81
Table 4.1	Numbers of species by visual observations in 2009 and 2010.	84
Table 4.2	Numbers of species by acoustic observations in 2009 and 2010.	84
Table 4.3	Numbers of species counted during morning walk in 2009 and 2010.	84
Table 4.4	Results of daytime visual (transects), night-time acoustic (calls) observations and morning census at Puttgarden onshore station: the 20 most frequent species per method are listed. Species ranked in the top 20 in both baseline years are shaded grey.	85
Table 4.5	Results of daytime visual (transects), night-time acoustic (calls) observations and morning census at Puttgarden onshore station in 2009. The 10 most frequent species per method are listed. Species belonging to more than one list are shaded grey.	87
Table 4.6	Results of daytime visual (transects), night-time acoustic (calls) observations and morning census at Rødbyhavn onshore station: the 20 most frequent species per method are listed. Species ranking in the top 20 in both baseline years are shaded grey.	88
Table 4.7	Results of daytime visual (transects), night-time acoustic (calls) observations and morning census at Rødbyhavn onshore station in 2009: the 10 most frequent species per method are listed. Species belonging to more than one list are shaded grey.	90
Table 4.8	Results of daytime visual (transects) and night-time acoustic (calls) observations at Fehmarnbelt offshore station: the 20 most frequent species per method are listed. Species ranking in the top 20 in both baseline years are shaded grey.	91
Table 4.9	Results of daytime visual (observations) and night-time acoustic (calls) observations at Fehmarnbelt offshore station in 2009: the 10 most frequent species per method are listed.	92
Table 4.10	Results of daytime visual (transects) and night-time acoustic (calls) observations at Hyllekrog offshore station in 2009: the 20 most frequent species per method are listed.	93
Table 4.11	Results (summed individuals / calls) of daytime visual (transects), night-time acoustic (calls) observations and morning census at all four field stations in 2009: results are displayed for species groups.	95
Table 4.12	Results (summed individuals / calls) of daytime visual (transects), night-time acoustic (calls) observations and morning census at all three field stations in 2010: results are displayed for species groups.	95
Table 4.13	Results from visual observations from all three baseline field stations in spring 2009 in comparison with results from Fehmarn (OAG), spring 2009. Accumulated sums are compared per season and species group. Values from other stations higher than values from baseline stations are marked in red.	98

FEHMARNBELT BIRDS

Table 4.14	Results of daytime visual observations from all three FEBI stations in autumn 2009 (FEBI data) in comparison with data from Fehmarn (OAG) and Falsterbo (SkOF): species groups. Values from other stations higher than values from own stations are marked in red.....	99
Table 4.15	Daily maxima recorded during daytime visual observations at Puttgarden and Rødbyhavn in spring 2009 and 2010 in comparison with OAG data from Fehmarn (2000-2009). Values from OAG higher than values from own stations are marked in red. Counts summed up over several observation points (Fehmarn (OAG)) are marked with *.....	100
Table 4.16	Daily maxima recorded during daytime visual observations in Puttgarden and Rødbyhavn in autumn 2009 and 2010 in comparison with OAG data from Fehmarn (2000-2009) and SkOF data from Falsterbo. Values from other stations higher than values from own stations are marked in red. Counts summed up over several observation points (Fehmarn (OAG)) are marked with *.	101
Table 4.17	Spearman correlations between the migration intensities as measured by different radars in 2010 at different locations. Given is the R^2 per possible meaningful combination; * indicates significant Spearman correlation.....	121
Table 4.18	Migration intensities at Fehmarnbelt area measured by Superfledermaus in in fixed pencil beam mode as migration traffic rate MTR [birds/km/hour]. The beam was directed along the coast measuring migration towards land.....	125
Table 4.19	Mean flight direction of bird species /groups in relation to expected mean migration direction for a) spring and b) autumn at Lolland, offshore (central) Fehmarnbelt (CFB) and Fehmarn. n = number of tracks; Rayleigh Test with $p < 0.05$ printed in bold = a significant main migration direction exists; V Test with $p < 0.001$ printed in bold = migration direction coincides with expected migration directions; those are "coasting": 130° in spring and 310° in autumn; "crossing": 25° in spring, 205° in autumn.....	153
Table 4.20	Statistics of vertical speed (V_z , cm/sec) for tracks with identified species, Rødbyhavn, spring 2009; only for species with $N \geq 10$. Data from tracking radar "Superfledermaus" were used.	213
Table 4.21	Statistics of vertical speed (V_z , cm/sec) for tracks with identified species, Rødbyhavn, autumn 2009; only for species with $N \geq 10$. Data from tracking radar "Superfledermaus" were used.....	214
Table 4.22	Ascending speed for several bird species (modified from Hedenström and Alerstam 1992). Data from tracking radar "Superfledermaus" were used.....	214
Table 4.23	Mean vertical speed (V_z) in relation to time of the observation (UTC) and cloud cover, autumn 2010, manual nocturnal tracks. Values calculated with less than 20 tracks were erased.	235
Table 4.24	Relation of mean vertical speed (V_z) and visibility conditions.....	236
Table 5.1	Summary of Kruskal-Wallis ANOVA by ranks – migration intensity at Puttgarden during spring 2010 for different wind components. Valid sample size (Valid N), p value of test (K-W test). Mean ranks of wind components and p values for significant results of multiple comparisons between wind components are given. For exact definitions of wind components see text.	245

FEHMARNBELT BIRDS

Table 5.2	Summary of Kruskal-Wallis ANOVA by ranks – proportion coasting migrants at Puttgarden during spring 2010 for different wind components. Valid sample size (Valid N), p value of test (K-W test), Mean ranks of wind components and p values for significant results of multiple comparisons between wind components are given. For exact definitions of wind components see text.	246
Table 5.3	Summary of Kruskal-Wallis ANOVA by ranks – proportion departing migrants at Puttgarden during spring 2010 for different wind components. Valid sample size (Valid N), p value of test (K-W test), Mean ranks of wind components and p values for significant results of multiple comparisons between wind components are given. For exact definitions of wind components see text.	247
Table 5.4	Summary of Kruskal-Wallis ANOVA by ranks – migration intensity at Rødbyhavn during autumn 2010 for different wind components. Valid sample size (Valid N), p value of test (K-W test), Mean ranks of wind components and p values for significant results of multiple comparisons between wind components are given. For exact definitions of wind components see text.	247
Table 5.5	Summary of Kruskal-Wallis ANOVA by ranks – proportion coasting at Rødbyhavn during autumn 2010 for different wind components. Valid sample size (Valid N), p value of test (K-W test), Mean ranks of wind components and p values for significant results of multiple comparisons between wind components are given. For exact definitions of wind components see text.	248
Table 5.6	Summary of Kruskal-Wallis ANOVA by ranks – proportion departing at Rødbyhavn during autumn 2010 for different wind components. Valid sample size (Valid N), p value of test (K-W test), Mean ranks of wind components and p values for significant results of multiple comparisons between wind components are given. For exact definitions of wind components see text.	249
Table 5.7	Summary of Kruskal-Wallis ANOVA by ranks – migration flight distance to Rødby during spring 2010 for different wind components. Valid sample size (Valid N), p value of test (K-W test), Mean ranks of wind components and p values for significant results of multiple comparisons between wind components are given. For exact definitions of wind components see text.	250
Table 5.8	Summary of Kruskal-Wallis ANOVA by ranks – migration flight distance at Puttgarden during autumn 2010 for different wind components. Valid sample size (Valid N), p value of test (K-W test), Mean ranks of wind components and p values for significant results of multiple comparisons between wind components are given. For exact definitions of wind components see text.	250